

A Connectionless Multicast Protocol for MANETs

Viet Thi Minh Do, Lars Landmark, Øivind Kure

Q2S, the Centre for Quantifiable Quality of Service in Communication Systems

Norwegian University of Science and Technology, Norway

{viet, lars.landmark, okure}@q2s.ntnu.no

Abstract—In this paper, the connectionless multicast routing MCOM (Multipoint relay Connectionless Multicast) is introduced for mobile Ad hoc networks. MCOM adapts over a wide range of density of group members. It appears as unicast with few receivers and as flooding protocol, similar to Simplified Multicast Forwarding (SMF), with many receivers. MCOM utilizes the forwarding structure Multipoint relay (MPR) of the proactive unicast routing protocols as duplication points. In MCOM, addresses of MPRs are included in data packets instead of addresses of receivers as in the traditional connectionless multicast protocol Xcast. After receiving multicast packets from source, specific MPRs use SMF to deliver the packets to receivers. Two simulators NS-2 and nsclick were used to evaluate performance of protocols. The results from our studies demonstrate that MCOM is an efficient multicast protocols over a wide range of scenarios.

I. INTRODUCTION

Mobile ad hoc networks (MANETs) have applications in a wide range of areas including videoconferencing, disaster relief, multigaming. Many of these scenarios require one to many or many to many communications. The delivery of packets is usually done by using multicast instead of multiple unicast connections. Multicast approaches reduce the number of transmissions from source to all destinations, thus reducing the overhead of traffic in the network. However, multicast protocols usually need to construct and maintain a tree/mesh structure for each multicast group. This construction and maintenance leads to high level of overhead and makes multicast complex. In some scenarios, e.g. high mobility scenarios, the cost of multicast is very high because state information tends to stale fairly quickly. In these scenarios, broadcasting is a preferable approach for group communication. However, if a broadcast protocol is designed for group communication, it will deliver packets to all nodes in the network regardless of who receivers are. The performance will reduce due to redundant wasteful transmissions. Therefore, there is a trade-off between multicast and broadcast approaches. The work in [1] shows that in scenarios with large multicast group size (more than 40% of the nodes are group members), broadcast approach may in fact be preferable than multicast approach. Depending on scenario or context, it may be preferable to use one versus other. Multicast members can freely join and leave the group, then the number of group member changes frequently. The existing protocols are typically designed for a specific range of density of group members. It is therefore a need of a routing protocol that enable nodes adapt to perform the right functions in respond to local conditions.

There has been earlier works [2] [3] [1] focused on compar-

ing different unicast, multicast, broadcast schemes. [2] compared two multicast protocols (Multicast Ad hoc On-Demand Distance Vector MAODV [4] and On-Demand Multicast Routing Protocol ODMRP [5]) with plain flooding protocol over a wide range of mobility, traffic source populations, and traffic load conditions. The paper has used two simulators NS-2 [6] and GloMoSim [7] to study the reliability of the different protocols. The general trend the paper observed is that for scenarios with moderate ratio between number of senders and number of receivers, flooding performs better than ODMRP which in turn perform better than MAODV in term of packet delivery ratio. ODMRP's overhead is considerably higher than flooding or MAODV because ODMRP has to periodically flood Join packets to maintain the mesh connectivity. Flooding provides a lowest average delivery delay since it almost always sends packets over the shortest paths to the receivers. The paper show that plain flooding performs relatively well compared to some existing multicast protocols in extremely dynamic networks.

Authors in [3] compared the use of unicast, multicast, and broadcast protocols to support a variety of many to many communication scenarios. The paper has used NS-2 to evaluate the performance of protocols. The paper investigated how to best support one-to-many and many-to-many communication in a MANET. The paper conducted simulations to evaluate the performance of a number of solutions to this problem: applying two unicast routing protocols (Dynamic Source Routing protocol DSR [8] and Ad Hoc On Demand Distance Vector AODV [9]), employing one of three multicast routing protocols (MAODV, ODMRP, or ADMR [10]), or using one of two broadcast protocols (plain flooding and BCAST [11]). The results show that multicast protocols such as ADMR or ODMRP do indeed provide superior performance compared to the use of unicast protocols. However, broadcast protocols fare equally well or better in the scenarios they studied, in particular with respect to packet delivery ratio, with little to no additional network overhead. Authors in [1] provided an evaluation of the trade-offs between broadcasting and multicasting in MANETs. The paper has used the simulator NS-2 to evaluate the performance of the multicast protocol ODMRP and the broadcast protocol SBA [12]. The results were shown that multicasting is preferable under conditions of moderate mobility and with density of group members smaller than 40% and broadcasting is preferable under conditions of high mobility and with high density of group member.

In this paper, we introduce the new protocol MCOM which

adapts to a wide range of density of group members. Moreover, MCOM has good performance in high mobility and traffic load environments. MCOM appears as unicast when the number of receivers is small, as multicast when the number of receivers is medium, and as broadcast when the number of receivers is large. The key idea of MCOM is the use of connectionless multicast [13] and Simplified Multicast Forwarding (SMF) [14] to deliver packets. The description of MCOM is presented more detail in section II. Two simulators NS-2 and nsclick were used in the paper. Nsclick [15] is constructed by embedding the Click Modular Router [16] inside of the NS-2 network simulator. When moving from simulation to test bed, source code usually needs to be reimplemented completely. However, the source code with nsclick may run both on actual systems as well as under simulator with minor modifications. For this reason, we chose nsclick as a simulator to evaluate protocols.

The outline of rest of the paper is as follows. In section II, we describe MCOM and the implementation of MCOM in nsclick. Simulation evaluations are provided in section III. Section IV concludes the paper and represents future research plan.

II. MCOM DESCRIPTION

A. MCOM overview

MCOM uses the idea of connectionless multicast routing and Simplified Multicast Forwarding to deliver multicast packets. The concept of Multipoint relay was developed to reduce the number of duplicate transmissions of pure flooding. In MPR-flooding, only subsets of neighbor nodes retransmit messages, unlike the pure flooding, where all the neighbors forward the messages. A neighbor node, which forwards a message, is referred to as relay node of the peer. Optimized Link State Routing Protocol (OLSR - RFC 3626) [17] is a proactive routing protocol for mobile ad hoc network. The multipoint relay is the key idea behind the OLSR protocol to reduce the information exchange overhead. In OLSR only the MPRs can forward the data throughout the network. OLSR is used as underlying unicast routing protocol in MCOM. Target applications of MCOM are applications which require high density of group members. OLSR was used because OLSR protocol is suited for dense networks. SMF provides an efficient flooding mechanism in MANETs to deliver multicast packets. A goal of SMF is to apply reduced relay sets for more efficient multicast dissemination within dynamic topologies. We used source-specific multi-point relay (S-MPR) flooding for SMF in MCOM. The S-MPR flooding mechanism is based on the MPR technique and allows only locally elected MPRs to retransmit packets that are received from upstream selector nodes.

In MCOM, when a source needs to deliver multicast packets to a multicast group it determines last-MPR nodes of multicast members. A last-MPR node is defined as a MPR node that connects to a member and distance from the MPR node to the source is shorter than distance from the member to the source. If the number of receivers connected to a last-MPR

node is larger than a threshold, the address of this last-MPR node will be included in the data packet. The data packets also includes addresses of the rest of receivers. Then data packet contains addresses of both last-MPR nodes and some receivers. In the traditional connectionless multicast protocol Xcast source puts all addresses of receivers in data packet. Both Xcast and MCOM assume that the underlying unicast routing protocol will deliver packets to all destinations.

As an intermediate node receives a data packet, it checks addresses included in the data packet. If address of the node is not listed in the data packet, the node looks up the routing table of unicast routing protocol to determine next hops. If there is more than one next hops, means that this node is a branching node, the packet will be duplicated and the list of appropriate receivers will be included in each copy of the packet. If address of the node is listed as the last-MPR node in data packet, the node will use SMF mechanism to deliver the packet. In the packet, the field time to live (TTL) is set to a specific number (for instance, TTL is set to 2) and the broadcast address is filled in the destination address field. Upon a node receives a SMF packet, it will decrease TTL to one and rebroadcast the packet if four following conditions are satisfied: 1) The node is MPR; 2) The node receives the packet for the first time and the packet has not been forwarded; 3) Distance from the node to the source is greater than distance from last-MPR to the source ; 4) TTL of the packet is greater than 1. We call this as the four-condition forwarding rule. The SMF technique used in MCOM can deal with the mobility problem in MANETs. When the links between last-MPRs and group members are broken, members can still receive multicast packets thanks to packet broadcasting of SMF.

With the four-condition forwarding rule, broadcast packets are spread out in a limited area and the transmission of packets towards source is avoided. Overhead of broadcasting packets is decreased by the SMF mechanism and the setting of the field TTL. When a source or an intermediate MPR node need to deliver a packet, it looks up unicast routing table to find out the next hops for the packet. The node can unicast or broadcast the packet to next hops. Unicast is reliability at layer two, then if the packet is lost it will be retransmitted towards the next hop. The lost packet will not be retransmitted in case of broadcast. The benefit of broadcast is the reduction of transmissions at the cost of reliability. The benefit of unicast is reliability at the cost of increased traffic. In MCOM, source and intermediate MPRs use unicast to deliver packets to next hops while last-MPRs broadcast packets to receivers by using SMF. This method helps to increase the reliability of data packet and reduce traffic transmission.

B. An example scenario

Figure 1 illustrates the delivery of data packets in MCOM. S is source and R1-R6 are multicast group members. As S needs to deliver multicast data packets to the multicast group, it checks the last-MPRs of destinations. Here, N3, N7, N8 are last-MPRs. In MCOM, source puts address of last-MPR when the number of destinations connected to the last-MPR is

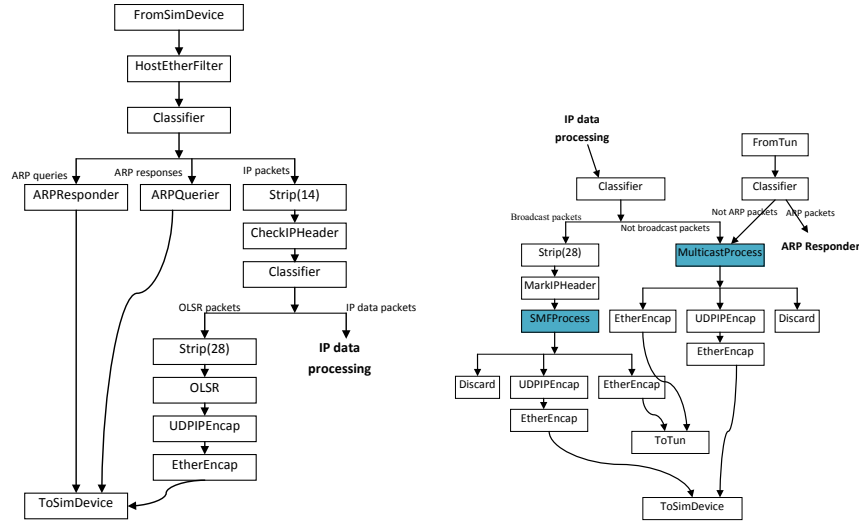

Fig. 2. Router configuration of MCOM in nsclick

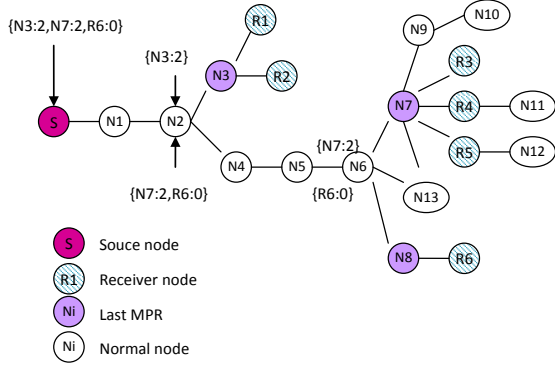

Fig. 1. An example of packet delivery in MCOM

higher than a threshold. We set the threshold of this scenario to 2. Addresses of N3 and N7 then are included in the data packet. The data packet at the source S has format $\{N3:2, N7:2, R6:0 \mid \text{Payload}\}$. The flag 2 means that N3 and N7 are last-MPRs and when these nodes receive this packet, they will simplified multicast forwarding the packet with TTL set to 2. The flag 0 means that R6 is a destination. When the data packet reaches the node N2, it will look up the OLSR routing table to find out next hops for the packet. The next hops for the packet in this case are N3 and N4. Node N2 is a branching node, it duplicates the data packet to two packets and unicast each packet to suitable next hop. The packet sent to N3 has format $\{N3:2 \mid \text{Payload}\}$, while the packet sent to N4 has format $\{N7:2, R6:0 \mid \text{Payload}\}$. When node N6 receives the packet, two packets with format $\{N7:2 \mid \text{Payload}\}$ and $\{R6:0 \mid \text{Payload}\}$ are created. As N7 receives the packet $\{N7:2 \mid \text{Payload}\}$, it prepare a SMF packet with TTL equal 2 and broadcast the packet. The destination R3, R4, R5 will receive the SMF packet and send it to upper layer (e.g. application layer). Node N9 will rebroadcast this SMF packet since four-conditions forwarding rule is satisfied.

C. MCOM implementation in nsclick

In order to implement MCOM in nsclick, we created two elements MulticastProcess and SMFProcess. The input of the element MulticastProcess is data packets from application layer and from network simulation device. If the data packets are from application layer, addresses of last-MPRs and receivers are put in the header of the data packets. If data packets from network simulation device and the node address is not listed in the header of packet, it means the node is not a receiver, then next hop nodes of the packet are determined by looking up the unicast routing table. If the data packet from network simulation device and the node is one of last-MPRs included in the header of the packet, the packets will be SMF if the four-conditions forwarding rule is satisfied. The input of element SMFProcess is SMF packets. If the node is a member it will send the packet to upper layer. If the node is a MPR node, it will decrease TTL by one and decide whether it rebroadcast the packet based on the four-conditions forwarding rule.

Figure 2 describes the router configuration of MCOM in nsclick. Packets can reach Click routing from simulator network interface by element *FromSimDevice* or from local system by element *FromTun*. After being read by element *FromSimDevice(tap0)*, packets are pushed to element *HostEtherFilter*. Ethernet packets sent to other machines are dropped by this element. This element expects Ethernet packets as input and acts basically like Ethernet input hardware for a device with address as argument of this element. *Strip* element is used to get rid of the Ethernet header. The validity of packets is checked by *CheckIPHeader*. Packets then classified by element *Classifier*. OLSR packets are passed to element *Strip* and finally pushed to simulated network device by *ToSimDevice*. IP data packets will be classified as broadcast packets and not broadcast packets. The first type of packet will pass to element *SMFProcess* and the second type of packet will reach *MulticastProcess*. Finally, the packets are sent to local system

by element *ToTun* or to simulator network interface by element *ToSimDevice*.

III. PERFORMANCE EVALUATION

We compared the performance of MCOM against the performance of Xcast and MAODV. Two simulation tools were used in the paper are nsclick and NS-2. Version of NS-2 is 2.34 while nsclick is integrated from NS-2.34 and Click-1.8.0. We implemented MCOM in nsclick and implemented Xcast in both nsclick and NS-2. Underlining unicast routing protocol for MCOM and Xcast was OLSR. Implementation of OLSR for nsclick in [18] and implementation of OLSR for NS-2 in [19] were used. Also, the paper used implementation of MAODV for NS-2 in [4].

A. Simulation environment

All simulations run on an Intel Pentium D workstation with 2GB of RAM, CPU 3.00GHz, Ubuntu Linux SMP 9.04. The simulations model networks with 50 nodes distributed randomly in the area 1500m x 500m. IEEE 802.11 was used in all simulations. Radio transmission range of each node was 250m and channel capacity was 2 Mbits/sec. There was no network partition during the simulation period. The Constant Bitrate (CBR) traffic was used with a wide range of traffic rate (from one packet/sec to 16 packets/sec). Packet size was 512 bytes. The mobility model of mobility node was Random Waypoint with pause time 0 second. Each node randomly selects moving direction and moves there at a random speed uniformly chosen from $[1, v_{max}]$, where v_{max} is the maximum speed of the node. We set a positive minimum speed with 1 m/s so that the system can reach a steady state in term of instantaneous average node speed [20]. All results provided were averaged over five executions of random simulation scenarios. Sources and receivers were selected randomly. Each simulation lasts 220 seconds. We used the confidence level of 0.95 and dropped data from the initial of the simulation. Several performance metrics were used to evaluate the proposal: Packet delivery ratio (PDR), packet overhead, and average packet delay.

- **Packet delivery ratio (PDR)** is the ratio of the number of packets actually received by the receivers to the expected number of packet reception.
- **Packet overhead** is the total number of duplicated packets received by all nodes in network divided by the total number of sending packets.
- **Average packet delay** is the average delay of each packet to all destinations.

Five experiments were carried out to determine the effect of traffic load, mobility, and density of group members on the performance metrics for each protocol. The details of each experiment performed are as follows:

- Experiment 1: Mobility of all nodes was 0 meters/second (m/s). The number of receivers was 15 nodes. Traffic load was varied across the values 1, 2, 4, 8, 16 packets/sec. The aim of this experiment is to study how the protocols behave under conditions of overload. The nodes were stationary so that the packet drops that occurred were

due to collisions and congestion. Results are indicated in Figure 3.

- Experiment 2: 15 receivers were selected randomly among 50 nodes, the maximum speed of nodes was varied from 1 m/s to 20 m/s. The traffic load of the network was kept constant at 8 packets/sec. Results are presented in Figure 4. The experiment is to study the effect of mobility on the performance of MCOM and Xcast.
- Experiment 3: 15 receivers were selected in some areas so that the number of receivers in a same small area is large. It means that the number of receivers connected to a MPR is high. Here, three groups of receivers were formed, each group has 5 near-by receivers. The experiment was run with five random scenarios. Maximum speed of nodes was ranged from 1 m/s to 20 m/s. The traffic load of the network was kept constant at 8 packets/sec. The objective of this experiment is to investigate the advantage of SMF technique in MCOM with scenarios that have groups of near-by receivers and high mobility.
- Experiment 4: Maximum speed of nodes was fixed at 10 m/s. The number of receivers varied from 1 receiver to 50 receivers. The percentage of receivers is defined as the percent of number of group members to the total number of nodes. The percentage of receiver and total network node then varied from 2 % to 100%. The load of the network was kept constant at 8 packets/sec. Results are indicated in Figure 6.
- Experiment 5: In four above experiments Xcast and MCOM were implemented and run in nsclick. In experiment 5, we implemented Xcast in NS-2 and used implementation of MAODV for NS-2 from [4]. We run simulations with network parameters as the same as network parameters in experiment 4. Performance of Xcast is considered as base line. The experiment aims to compare performance of MCOM with the base line. Results are indicated in Figure 7 and Figure 8.

B. Results and discussion

Figure 3 presents the packet delivery ratio, overhead, and delay versus traffic load of Xcast and MCOM. As shown in the figure, MCOM has a better delivery performance than Xcast in particular when the traffic load is high. Overhead of MCOM are lower than that of Xcast. Delay of two protocols is similar to each other when traffic load equals or less than 8 packets/sec. However, when the traffic is 16 packets/sec, delay of Xcast is dramatically higher than delay of MCOM. In Xcast multicast packets are unicast to receivers. As traffic load is high, more packet loss leads to many retransmissions of packets at layer two and network becomes overload and performance is significantly reduced. In MCOM, last-MPR uses broadcast to deliver packet to receivers. Moreover, the broadcast in MCOM is limited by four-condition forwarding rule so it does not consume much resource. This is the reason why MCOM has better performance than Xcast. It is also can be seen that the packet delivery ratio of two protocols decreases when traffic load increases. This is due to the fact

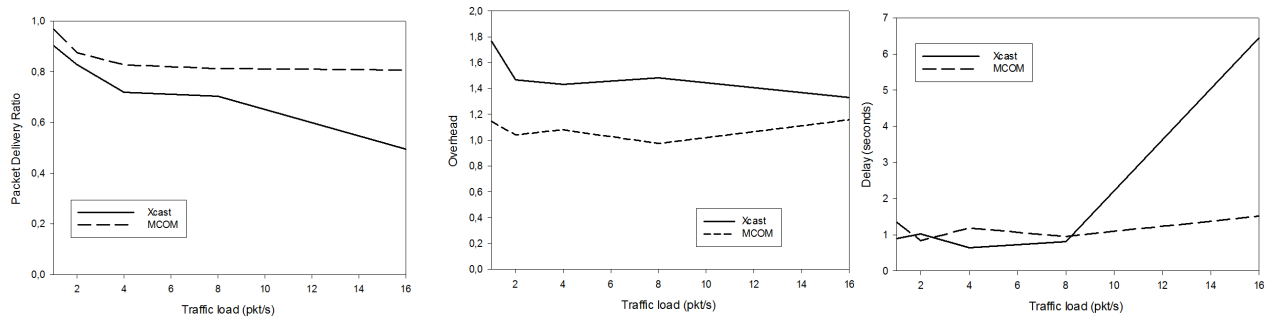

Fig. 3. Packet delivery ratio, overhead, and delay versus traffic load

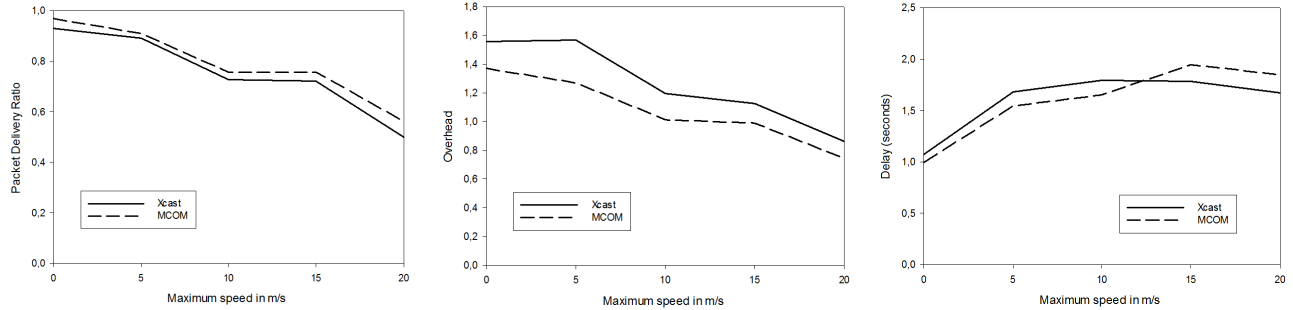

Fig. 4. Packet delivery ratio, overhead, and delay of protocols in scenarios with 15 random receivers versus mobility

that when traffic load increases in a network, the network gets congested and collision happens, more packets are dropped as a result.

Figure 4 depicts the comparison of packet delivery ratio, packet overhead, and average packet delay with the two protocols at various mobility. It can be seen that PDR of both protocols decreases when the mobility of nodes increases. The link breaks happen more frequently when the mobility of nodes is high. It takes time for the routing protocol to recover the correct route and packet loss ratio is high as a result. PDR of MCOM is slightly higher than that of Xcast while overhead and delay of MCOM is slightly lower than that of Xcast. In Xcast the delivery of packet from a last node is done by multiple unicast to receivers while in MCOM the packet is broadcast to receivers. This leads to higher overhead in Xcast compared to MCOM. MCOM has lower delay than Xcast when the mobility is lower than about 12 m/s and delay of MCOM is higher than that of Xcast when the mobility is higher than about 12 m/s. In high mobility networks, some receivers may move out of range of its last-MPR, these receivers might lose packets in Xcast but they can still receive packets in MCOM because the last-MPR will broadcast the packets in the range of two hops. The delay of packet for these receivers will increase, then the average packet delay of MCOM will increase. However, in general the performance of Xcast and MCOM is mostly the same. In scenarios where receivers are distributed sparsely, the number of receivers connected a last-MPR is small. Then the addresses of receivers are included in data packets instead of addresses of MPRs. In such scenarios with the medium traffic load MCOM

appears as Xcast.

Figure 5 presents the packet delivery ratio of Xcast and MCOM in experiment 3. As shown in this figure packet delivery ratio of MCOM is much higher than that of Xcast as the mobility of nodes is medium or high (from 10 m/s to 20 m/s). The packet loss of Xcast in high mobility cases is mostly due to link breaks between nodes. It takes time for routing protocol to repair the broken links and packets are loss during this period. In MCOM, we used SMF to deal with mobility. Packets are partly broadcast towards receivers by SMF, then the packet loss is reduced by redundant links and redundant packets. In addition, the overhead of broadcast is minimized by four-condition forwarding rules.

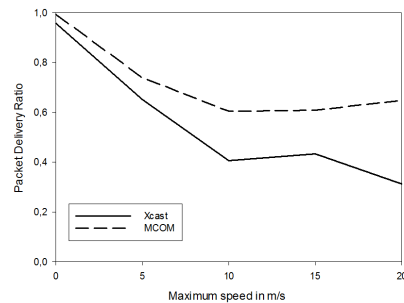

Fig. 5. Packet delivery ratio of protocols in scenarios with 15 near-by receivers versus mobility

The results of experiment 4 are presented in Figure 6. As can be seen from this figure, MCOM has significant higher packet delivery ratio than Xcast when increasing the density

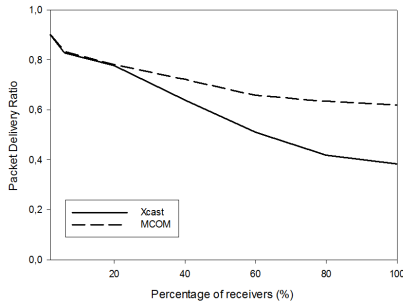

Fig. 6. Packet delivery ratio of protocols in scenarios with various density of group members

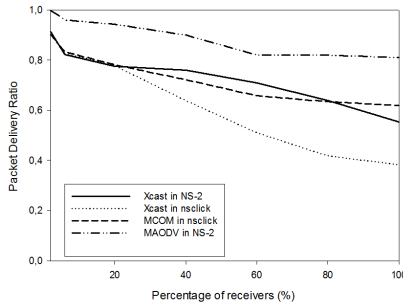

Fig. 7. Packet delivery ratio of protocols with various density of group members

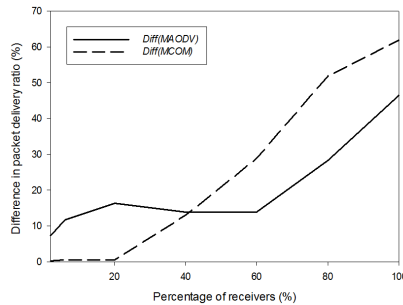

Fig. 8. Difference between packet delivery ratio of two protocols and Xcast with various density of group members

of group members. For instance, as the percentage of receivers is 40%, packet delivery ratio of MCOM is 13% higher than that of Xcast; as the percentage of receivers is 80%, packet delivery ratio of MCOM is 52% higher than that of Xcast. When the percentage of receivers increases, receivers tend to be close to each other. The number of last-MPRs included in data packets is higher. In addition, the large number of addresses included in packets in Xcast causes high overhead in network. In this case, MCOM utilizes the characteristic of connectionless and SMF to get higher performance.

Figure 7 shows packet delivery ratio of MCOM, Xcast in NS-2 and MAODV, Xcast in nsclick. Interestingly, the performance of Xcast in NS-2 is much different from the performance of Xcast in nsclick although all parameters are

kept the same in both simulators. This result is because each simulator has different characteristics that effects the performance of protocols. To compare the performance of MCOM and MAODV, we keep Xcast as a base line. The difference between packet delivery ratio of MCOM as well as MAODV and Xcast in simulators is calculated. Difference between packet delivery ratio of MCOM and Xcast in nsclick and difference between packet delivery ratio of MAODV and Xcast in NS-2 are called $Diff(MCOM)$ and $Diff(MAODV)$ respectively. Intuitively, if $Diff(MCOM)$ is higher than $Diff(MAODV)$ then MCOM has packet delivery ratio better than MAODV and inverse.

$$Diff(MCOM) = \frac{PDRofMCOMinnsclick - PDRofXcastinnsclick}{PDRofXcastinnsclick} * 100$$

$$Diff(MAODV) = \frac{PDRofMAODVinns2 - PDRofXcastinns2}{PDRofXcastinns2} * 100$$

Figure 8 represents the difference between packet delivery ratio of MCOM and Xcast at various density of group members. It can be seen that $Diff(MCOM)$ lower than $Diff(MAODV)$ when the percentage of receivers is lower than about 42% and $Diff(MCOM)$ is higher than $Diff(MAODV)$ when the percentage of receivers is about 42%. One of disadvantages of MAODV is that many messages in MAODV are transmitted by blind flooding. Rout requests RREQs and group hello message GRPH are forwarded to entire network, this will consume the valuable network resources, and may cause network congestion, then increases packets collision probability and packets loss. The node once found the broken link, it will send RRER (route error) to notify the source node to dispose correspondingly. This is a passive procedure that takes action only after the breakage of the link. This can result in poor network performance. Due to the use of MPRs in MCOM, the overhead of maintaining correct routes is minimized. Also, when the number of receivers increases, the redundant links and redundant packets are provided by SMF help MCOM adapt quickly with the breakage of links. For these reasons, MCOM perform better than Xcast when the percentage of receivers is high. From the results, it can be concluded that MCOM, which can adapt over a wide range of density of group members, is an effective approach for group communication. MCOM also has good performance in scenarios with high mobility and high traffic load.

IV. CONCLUSION

In this paper, we design the multicast routing protocol MCOM that enable nodes adapt to perform well in response to density of group members in MANETs. MCOM uses the idea of connectionless multicast and multipoint relay to reduce overhead and increase the delivery performance. In order to validate our proposal we compared the performance of MCOM with Xcast and MAODV in various scenarios. Results show

that MCOM is not only adapt over a wide range of density of group members but also perform well in high mobility and traffic load environment. Our objective in near future is to move the code from *nsclick* to a test bed system to get the comparison of protocols.

REFERENCES

- [1] L. K. Law, S. V. Krishnamurthy, and M. Faloutsos, "On evaluating the trade-offs between broadcasting and multicasting," in *IEEE MILCOM*, 2004.
- [2] K. Obraczka, G. Tsudik, and K. Viswanath, "Pushing the limits of multicast in ad hoc networks," in *Distributed Computing Systems, 2001. 21st International Conference on.*, apr 2001, pp. 719–722.
- [3] T. Kunz, "Multicast versus broadcast in a manet," in *Ad-Hoc, Mobile, and Wireless Networks*, ser. Lecture Notes in Computer Science, I. Nikolaidis, M. Barbeau, and E. Kranakis, Eds. Springer Berlin / Heidelberg, 2004, vol. 3158, pp. 630–630.
- [4] Y. Zhu and T. Kunz, "Maadv implementation for ns-2.26," January 2004. [Online]. Available: <http://kunz-pc.sce.carleton.ca/thesis/maadv-ns-2.26.pdf>
- [5] "On-demand multicast routing protocol (odmrp) for ad hoc networks," November 2002. [Online]. Available: <http://tools.ietf.org/id/draft-ietf-manet-odmrp-04.txt>
- [6] "The network simulator - ns-2." [Online]. Available: <http://www.isi.edu/nsnam/ns/>
- [7] X. Zeng, R. Bagrodia, and M. Gerla, "Glomosim: a library for parallel simulation of large-scale wireless networks," *SIGSIM Simul. Dig.*, vol. 28, no. 1, pp. 154–161, Jul. 1998. [Online]. Available: <http://doi.acm.org/10.1145/278009.278027>
- [8] "The dynamic source routing protocol (dsr) for mobile ad hoc networks for ipv4." [Online]. Available: <http://www.ietf.org/rfc/rfc4728.txt>
- [9] "Ad hoc on-demand distance vector (aodv) routing." [Online]. Available: <http://www.ietf.org/rfc/rfc3561.txt>
- [10] D. B. J. Jorjeta G. Jetcheva, "The adaptive demand-driven multicast routing protocol for mobile ad hoc networks (admr)," July 2001. [Online]. Available: tools.ietf.org/html/draft-ietf-manet-admr
- [11] W. Lou and J. Wu, "On reducing broadcast redundancy in ad hoc wireless networks," *Mobile Computing, IEEE Transactions on*, vol. 1, no. 2, pp. 111–122, apr-jun 2002.
- [12] "A mobile ad hoc wireless research group in the department of math and computer science, colorado school of mines." [Online]. Available: <http://toilers.mines.edu>
- [13] W. L. D. Ooms, "Connectionless multicast, ietf internet-draft," April 2000. [Online]. Available: <http://tools.ietf.org/html/draft-ooms-cl-multicast-00>
- [14] J. Macker, J. Dean, and W. Chao, "Simplified multicast forwarding in mobile ad hoc networks," in *Military Communications Conference, 2004. MILCOM 2004. IEEE*, vol. 2, oct.-3 nov. 2004, pp. 744–750 Vol. 2.
- [15] M. Neufeld, A. Jain, and D. Grunwald, "Nsclick:: bridging network simulation and deployment," in *Proceedings of the 5th ACM international workshop on Modeling analysis and simulation of wireless and mobile systems*. ACM Press, 2002, pp. 74–81.
- [16] R. Morris, E. Kohler, J. Jannotti, and M. F. Kaashoek, "The click modular router," *SIGOPS Oper. Syst. Rev.*, vol. 33, no. 5, pp. 217–231, 1999.
- [17] P. Jacquet, P. Muhlethaler, T. Clausen, A. Laouiti, A. Qayyum, and L. Viennot, "Optimized link state routing protocol for ad hoc networks," in *Multi Topic Conference, 2001. IEEE INMIC 2001. Technology for the 21st Century. Proceedings. IEEE International*, 2001, pp. 62–68.
- [18] J. Klein, "Implementation of an ad-hoc routing module for an experimental network." [Online]. Available: <http://www.pats.ua.ac.be/software/olsr/>
- [19] F. J. Ros, "Um-olsr." [Online]. Available: <http://sourceforge.net/projects/um-olsr/>
- [20] J. Yoon, M. Liu, and B. Noble, "Random waypoint considered harmful," in *INFOCOM 2003. Twenty-Second Annual Joint Conference of the IEEE Computer and Communications. IEEE Societies*, vol. 2, march-3 april 2003, pp. 1312–1321 vol.2.