

Leiv Inge Aa

The Grammar of Verb-Particle Constructions in Spoken Norwegian

Thesis for the degree of Philosophiae Doctor

Trondheim, June 2015

Norwegian University of Science and Technology
Faculty of Humanities
Department of Language and Literature



NTNU – Trondheim
Norwegian University of
Science and Technology

NTNU
Norwegian University of Science and Technology

Thesis for the degree of Philosophiae Doctor

Faculty of Humanities
Department of Language and Literature

© Leiv Inge Aa

978-82-326-0984-0 (print)
978-82-326-0985-7 (digital)
1503-8181

Doctoral theses at NTNU, 2015:164

Printed by NTNU Grafisk senter

Contents

| | |
|---|------------|
| Preface | i |
| 1 Introduction | 1 |
| 1.1 Verb-Particle Data and Research Questions | 2 |
| 1.1.1 The Alternation Problem and its Possible Solution | 2 |
| 1.1.2 More Norwegian Data to Be Considered..... | 5 |
| 1.1.3 Norwegian in a Scandinavian Perspective | 11 |
| 1.1.4 Some Notes Concerning the Norwegian Language Situation – and My Rendition of Norwegian Examples | 14 |
| 1.2 The Theoretical Framework | 16 |
| 1.2.1 Generative Grammar and (Bare) Phrase Structure..... | 17 |
| 1.2.2 Syntactic Frame Models | 25 |
| 1.3 Dialect Syntax and Parameters | 33 |
| 1.3.1 Dialect Syntax in the GB Style Principles and Parameters Framework..... | 34 |
| 1.3.2 Newmeyer’s (2005) Objections and Suggestions..... | 37 |
| 1.3.3 Minimalist Parameters..... | 39 |
| 1.3.4 Phrase Structural vs. Operational Variation..... | 40 |
| 1.3.5 Language-External Factors | 43 |
| 1.3.6 Conclusion | 45 |
| 1.4 Methods and Tools | 46 |
| 1.4.1 Introspective Examples..... | 47 |
| 1.4.2 Fieldwork and Acceptability Judgement Tests..... | 51 |
| 1.4.3 Corpus Data | 54 |
| 1.4.3.1 Corpus Studies in General | 54 |
| 1.4.3.2 The Nordic Dialect Corpus: Dialects, Transcription, and Informants..... | 55 |
| 1.4.4 Norsk Ordbok..... | 60 |
| 1.4.5 Norwegian Dialectological Sources | 61 |
| 1.5 The Structure of the Thesis and Summary of the Research Questions | 62 |
| 2 Norwegian Verb-Particle Data | 65 |
| 2.1 Standard VPrt Constructions | 66 |
| 2.1.1 Previous Accounts | 66 |
| 2.1.2 The Nordic Dialect Corpus | 72 |
| 2.1.2.1 Search Interface | 72 |
| 2.1.2.2 The Specific Searches | 74 |
| 2.1.2.3 Results..... | 76 |
| 2.1.3 Pilot Fieldwork in Trøndelag and Nordmøre 2009–10..... | 82 |
| 2.2 V + LPrt Spelled out with Word Accent | 84 |
| 2.3 Complex VPrt Constructions | 85 |
| 2.3.1 VPrt Constructions Followed by a Resultative PP | 85 |
| 2.3.2 Constructions with Complex Phrasal Particles | 89 |
| 2.4 A Second Group of VPrt Constructions | 91 |
| 2.5 Unaccusative VPrt Constructions | 93 |
| 2.6 Med ‘With’ and Its Role in Complex VPrt constructions | 95 |
| 2.7 Conclusion | 97 |
| 3 Some Previous Theoretical Accounts | 99 |
| 3.1 Taraldsen (1983): VPrt Constructions as Causatives | 101 |
| 3.1.1 Prt–DP Base Order and RPrt Constructions as Causative SCs | 101 |
| 3.1.2 Binding Theory and the Identification of Subjects | 101 |

| | | |
|------------|--|------------|
| 3.1.3 | Reanalysis, the Status of P, and Case Assignment | 105 |
| 3.1.4 | Conclusion | 110 |
| 3.2 | Áfarli (1985): Causatives with a DP–Prt Base Order | 111 |
| 3.2.1 | The Basic Order and the Critique of Taraldsen (1983) | 111 |
| 3.2.2 | VPrt Constructions as Causatives | 114 |
| 3.2.3 | The Predicational Nature of VPrt Constructions | 115 |
| 3.2.4 | Conclusion: Ignoring the Dialectology | 117 |
| 3.3 | Den Dikken (1995): The Particle as an Ergative Head of the SC | 117 |
| 3.3.1 | The Basic Structure and Derivations | 117 |
| 3.3.2 | Complex Constructions and the LPrt/RPrt Alternation | 119 |
| 3.3.3 | Simplex Constructions | 122 |
| 3.3.4 | The Ergative Particle | 125 |
| 3.3.5 | Particle Modification | 129 |
| 3.3.6 | Conclusion | 131 |
| 3.4 | Svenonius (1996a): SC Structure with EPP-Driven Movement | 132 |
| 3.4.1 | The Basic Structure | 132 |
| 3.4.2 | EPP and L-Selection | 133 |
| 3.4.3 | Scandinavian Variation and Subject Positions | 136 |
| 3.4.4 | Evaluation (and the Data Problem) | 138 |
| 3.5 | Zeller (2001): The Particle as Head of a Lexical Complement of the Verb | 140 |
| 3.5.1 | Introduction | 140 |
| 3.5.2 | The LPrt and RPrt Alternation | 141 |
| 3.5.3 | The Particle as a Lexical V-Complement | 143 |
| 3.5.4 | The in Situ Particle | 148 |
| 3.5.5 | The Non-Predicational Structure of PPs and VPrt Constructions | 149 |
| 3.5.6 | Conclusion | 154 |
| 3.6 | Ramchand & Svenonius (2002) and Ramchand (2008): L-syntax and Decomposed VP | 155 |
| 3.6.1 | The Decomposed VP in Ramchand & Svenonius (2002) | 155 |
| 3.6.2 | The LPrt and RPrt Alternation: Leftward Particle Movement to Identify Result State | 156 |
| 3.6.3 | Case Licensing | 158 |
| 3.6.4 | Head Movement and Constraints | 159 |
| 3.6.5 | Resultative APs | 160 |
| 3.6.6 | Ramchand (2008) | 161 |
| 3.6.7 | Conclusion | 163 |
| 3.7 | Conclusion Regarding Previous Theoretical Accounts | 163 |
| 4 | The Syntax and Semantics of Norwegian Verb-Particle Constructions | 165 |
| 4.1 | The Basic Order | 166 |
| 4.1.1 | Prt–DP vs. DP–Prt | 166 |
| 4.1.2 | Some General Notes on the Complexity of the Derivation | 171 |
| 4.2 | The Structure of VPrt Constructions | 173 |
| 4.2.1 | The Particle Lexicalising a Dynamic Node | 173 |
| 4.2.2 | The Particle Lexicalising Proc? | 179 |
| 4.3 | The Derivation of Directional and Metaphorical VPrt Constructions | 181 |
| 4.3.1 | Structural Semantics, Lexical Semantics, and World Knowledge | 181 |
| 4.3.2 | The Structure as the Primary Carrier of Meaning | 182 |
| 4.3.3 | Particle Movement or Lexical Insertion in VPrt Frames? | 186 |
| 4.3.4 | The Basic Semantics of Prepositions and the Lexical Modification of the Structure | 194 |
| 4.3.5 | World Knowledge: S-semantic Modification of Structural Semantics | 203 |
| 4.3.6 | Two Types of LPrt Constructions: Predicational and Non-Predicational | 206 |
| 4.3.7 | Verbs with Inherently Specified Direction | 213 |

| | | |
|------------|---|------------|
| 4.3.8 | The Weakening of the Predication in LPrt Constructions | 216 |
| 4.4 | Complex VPrT Constructions | 217 |
| 4.4.1 | Constructions with a Full Resultative PP | 217 |
| 4.4.2 | Constructions with Complex Phrasal Particles | 223 |
| 4.5 | On the Mainland Scandinavian Variation | 227 |
| 4.5.1 | Swedish in the Norwegian Frames | 228 |
| 4.5.2 | Predicational Structure with Rightward DP Shift | 231 |
| 4.5.3 | Non-Predicational Structures But Different Semantic Nodes | 234 |
| 4.5.4 | Conclusion | 236 |
| 4.6 | A Bilingual Approach to the Norwegian Written Standards | 237 |
| 4.6.1 | Micro-Variation as Bilingualism | 237 |
| 4.6.2 | Spoken Norwegian, Written Norwegian, and Written Danish | 237 |
| 4.6.3 | The Historical Role of Danish in the Norwegian Standard(s) | 239 |
| 4.6.4 | Prescriptive Syntax | 240 |
| 4.6.5 | Particle Alternation as the Result of Parallel Grammars? | 242 |
| 4.6.6 | Conclusion | 243 |
| 4.7 | Conclusion | 244 |
| 5 | More Norwegian Verb-Particle Constructions | 246 |
| 5.1 | A Second, Non-Predicational Group of VPrT Constructions | 246 |
| 5.1.1 | Two Groups of VPrT Constructions (\pm Predication) | 246 |
| 5.1.2 | A Preliminary Typology of VPrT Constructions | 255 |
| 5.2 | Unaccusative VPrT Constructions | 257 |
| 5.2.1 | Unaccusative VPrT Constructions as Predicational? | 257 |
| 5.2.2 | The Unaccusative Structure | 260 |
| 5.3 | Movement or Insertion in Frames? | 267 |
| 5.4 | More on (Impersonal) Meteorological Constructions | 281 |
| 5.5 | Conclusion | 287 |
| 6 | <i>Med</i> 'with' as a Verb-Particle and Its Juxtaposition Semantics | 289 |
| 6.1 | Some Observations from the Literature Regarding <i>med</i> 's Ability to Select SCs ... | 290 |
| 6.2 | "Double" VPrT Constructions – One or Two Particles? | 293 |
| 6.3 | <i>Med</i> 's Role in "Double" VPrT Constructions | 298 |
| 6.4 | The Semantics of <i>med</i> – A Juxtaposing Preposition | 301 |
| 6.5 | The Licensing of a SC Complement | 305 |
| 6.6 | The "Double" Constructions in a Representational Model | 308 |
| 6.7 | Conclusion | 316 |
| 7 | Conclusion | 318 |
| | References | 328 |

Preface

When I was working as a full-time editor for *Norsk Ordbok* (the Norwegian dictionary of spoken language and the *Nynorsk* written language) in Oslo, I had the opportunity do much empirical research on and write dictionary articles about several prepositions. In 2008, when I worked on the *opp* ‘up’ material, I found a passage from Ivar Aasen’s (1848: § 335) descriptive grammar of spoken Norwegian, where he claimed that particles in Norwegian were generally distributed to the left of the object DP. The linguistic literature had to my knowledge ‘always’ claimed a free particle alternation in Norwegian. I got curious about these basic discrepancies, thinking that they could be an interesting starting-point for a research project.

I knew Professor Tor Anders Åfarli from my student days at NTNU, and he had already supervised my MA project some years in advance. He was my obvious choice to supervise this project as well, and I am very glad that he wanted to. Tor is in addition to being a very nice person, also a very smart one, which is not a disadvantage. His theoretical knowledge is impressive, and his ‘empirical sharpness’ is a great privilege to exploit. I am very grateful to have known and collaborated with him for the last (almost) 15 years, and he has definitely been my most important intellectual contributor and inspiration over the years. Fortunately, we share the same interest for improvised music as well. On our first intended meeting on this project, we did not get beyond music at all, and I ended up in my office with Max Roach and Archie Shepp’s *The Long March* (1979). It has indeed been a long march, and of course the choice of record was purposive. Tor is also an excellent pedagogue.

This work has been funded by the Norwegian Research Council and is part of the Norwegian Dialect Syntax (*NorDiaSyn*) project, which came to an end in the autumn of 2014 and was led by Professor Janne Bondi Johannessen at the University of Oslo. *NorDiaSyn* was part of the former Scandinavian umbrella project *ScanDiaSyn*, led by Professor Øystein Alexander Vangsnes at the Arctic University of Tromsø. I owe both Janne and Øystein a great debt of gratitude for their great leadership, and also for stimulating the general interest for dialect syntax in Scandinavia.

Other people have been important during my years at NTNU as well. I will thank Ivar Berg, Heidi Brøseth, Guro Busterud, Stian Hårstad, Inger Johansen, Mari Nygård, Kaori Takamine, and the other (present and earlier) colleagues at the Nordic section for their good companionship and our discussions. I will also thank Frode Lerum Boasson for our

stimulating conversations, mainly while skiing. People from Bergen are generally better talkers than skiers, but Boasson masters both (simultaneously). Thank you also to the ‘grown’ people at the department for great and inspiring teaching and friendship over the years: Kristin Melum Eide, Brit Mæhlum, Jan Ragnar Hagland, and Randi Alice Nilsen.

Between my MA and my PhD projects, I worked four years for the above-mentioned dictionary in Oslo. These were very important years to me both intellectually and socially, during which I significantly increased my empirical knowledge about prepositions (and Norwegian language in general). I will thank all the nice, funny, and dedicated people at *Norsk Ordbok*. Especially I will thank the project director, Dr. Åse Wetås, for her great leadership, and also for having confidence in my long-distant part-time dictionary work during the PhD years in Trondheim.

The fact that we have a written standard (*Nynorsk*) derived from the spoken varieties, and also that the spoken varieties have a high status in Norway today, is not only a gift for dialectological researchers, but it is a democratic victory that cannot be taken for granted. For this, Ivar Aasen should be eternally thanked. *Takk, Ivar Aasen.*

In the spring of 2014, Dr. Mikael Vinka from the University of Umeå ‘mock-opposed’ my project, and his detailed and insightful feedback increased the quality of my thinking significantly. I am grateful for all the work he put into it, and generally he impressed me by his wide theoretical and empirical linguistic knowledge. I am also indebted to Professor Terje Lohndal for reading through the manuscript at a late stage and making invaluable comments and a detailed review. His insight in the field and work capacity are unbelievably impressive. I will also thank Bridget Samuels for proofreading of the script. Her contribution was much more than I could have asked for, since she also gave fruitful and insightful comments on the content.

I will emphasise that none of the good people who have helped me with this work are to blame for remaining errors and flaws, which are solely my own.

Last, and most importantly, I will thank my three daughters; two of them, Astrid and Ingjerd, have grown significantly during the project, and they have learned to talk, and even provided me with data. Johanne just managed to be born two months before the submission of the thesis, but is not to blame for any delays. My wife, Nina, is the most important person to me in all respects. She has contributed more to this work than (I think that) she thinks. In some sense, the work has been done *with* her; therefore, chapter 6 is for her.

Leiv Inge Aa, *Sogndal, May 2015*

1 Introduction

This thesis is about the syntactic structure and the semantics of verb-particle (VPrt) constructions in spoken Norwegian. VPrt constructions are highly interesting both empirically and theoretically, as they show diverging patterns even among closely related languages and dialects. Furthermore, they raise fundamental questions about the nature of language, and about the theory of language structure.

The thesis is divided into seven chapters. An overview of chapters 2–7 is given at the end of the present chapter, in section 1.5. Here, in the introductory chapter, I will be concerned with the following:

Section 1.1 introduces the most central and interesting data that will be discussed and analysed in the thesis. I will also give a short introduction to the theoretical problems raised by the data, and thus formulate crucial research questions. Overall, however, the main purpose of 1.1 is to introduce the wide range of empirical issues to be discussed in more detail in later chapters.

In 1.2, I discuss the general theoretical assumptions of the thesis. My approach is generative broadly speaking, and builds upon both Government and Binding (GB) theory (Chomsky 1981) and the Minimalist Program (MP, Chomsky 1993, 1995). In my work, I will start out using a traditional derivational analysis, but I will eventually explore the data with a neo-constructionist exoskeletal approach (cf. Borer 2005), i.e., in a syntactic frame model. This is reflected in 1.2, where I will discuss both “traditional” generative theories (such as GB and MP theory) and neo-constructionist theories. A crucial part of the discussion relates to the syntax–semantics interface, and more precisely what counts as purely linguistic information, and what instead belongs to the general-conceptual domain.

In the generative literature dealing with analyses of closely related languages (so-called micro-comparative syntax), the Principles and Parameters (P&P) approach has been central since Chomsky (1981). In 1.3, I discuss the P&P approach to micro-comparative syntax and compare it with a rule-based approach, as suggested by Newmeyer (2005). The P&P approach is essential to the generative tradition, and it has contributed to a significant increase in empirical knowledge of Scandinavian dialect syntax. I will also present some language-external factors in 1.3, though these are not the main focus of the thesis.

In 1.4, I present the methods and tools that I use. There are two major directions that will be discussed: 1) introspection and fieldwork using judgement tests (i.e., judgements as a

window into the minds of the informants), and 2) authentic data including corpus data and general dialectological data. In particular, I will take special advantage of the Nordic Dialect Corpus (Johannessen et al. 2009), and this will be the main focus of 1.4.

As already mentioned, section 1.5 ends chapter 1 by giving an overview of chapters 2–7.

1.1 Verb-Particle Data and Research Questions

1.1.1 *The Alternation Problem and its Possible Solution*

In Norwegian, the verb-particle is usually claimed to be distributed optionally to the left or right of an associated DP. The alternatives are shown in (1) (taken from Åfarli 1985: 75), where *ut* ‘out’ is the particle:

- (1) a. Jon sparka hunden ut.¹
 ‘John kicked the dog out’
 b. Jon sparka ut hunden.
 ‘John kicked out the dog’

The word order optionality illustrated by this simple pair has sparked much discussion over the years, two of the major questions being (i) *What is the basic word order?* and (ii) *How are the two alternative word orders derived?* In principle, there are four possible solutions to this set of questions, as noted by Åfarli (1985: 75). If (1a) is the basic order, the surface order of (1b) might be derived by particle movement to the left or DP movement to the right. If (1b) is the basic order, the order in (1a) might be derived by DP movement to the left or particle movement to the right. Which solution is ultimately chosen could depend on what we consider to be the essential relation between the involved units, i.e., the verb, the particle and the DP. Small Clause (SC) theories generally take the DP–Prt relation as essential, claiming there is a subject–predicate relation between the two. Others promote the V–Prt relation,² and

¹ Norwegian features two written standards, *Nynorsk* and *Bokmål*. The examples from Åfarli (1985) are mainly in standard *Nynorsk* (although these particular examples can appear identically in *Bokmål*). In this thesis, I will by default render my Norwegian examples in *Nynorsk*. If an example is taken from *Bokmål* or a dialect, this will be specified explicitly. I will discuss the Norwegian political language situation briefly – and also my rendition of Norwegian examples – in 1.1.4.

² Cf. the Complex predicate accounts, as referred to in Ramchand & Svenonius (2002).

some of these analyse the particle as incorporated into V, while some argue for the particle being separate from V.

In chapter 4, I will first pursue the hypothesis that Norwegian VPrt constructions are *predicational*, and thus that the associated DP has the properties of a subject. This also means that I basically consider VPrt constructions to be *resultatives*. However, we need to make a distinction between *directional* and *metaphorical (non-directional/idiomatic)* constructions,³ where only the former are actually true resultatives. We will see later that this distinction is also essential with respect to the word order variation. In short, we have a directional construction where the basic directional semantics of the particle itself can be recognised, as the case is in (1): *ut* ‘out’ – ‘from inside to outside’. We have a metaphorical construction where this directionality is not recognised. I show examples of the latter in (3) in section 1.1.2 below, and I will return to the directional–metaphorical distinction for full in sections 2.1 and 4.3.2.

Although I will pursue a predicational SC analysis of the VPrt construction, I will nevertheless question the fundamental parts of such an analysis, and eventually I will propose a more basic alternative, which challenges the traditional generative derivational approach. In the alternative analysis, (1a) and (1b) will be the result of lexical insertion into separate syntactico-semantic frames. This will in turn trigger an important discussion of the general semantics of the VPrt construction. What semantic information is given by the VPrt *structure*, what is given by the lexical elements (*sparke* ‘kick’ + *ut* ‘out’ + *hunden* ‘the dog’), and what is non-linguistic? These will be important questions in chapter 4 (from section 4.3 onwards).

I will contend that the two alternatives in (1) are semantically distinct, and given the three levels of semantic information mentioned above (structural, lexical, and non-linguistic semantics), it is important to stress that a main theoretical motivation to explore the diversity of the Norwegian VPrt data is to explore the syntax–semantics interface.

Since (1a) and (1b) differ semantically, it follows that they do not vary freely; we will show that (1b) is the preferred and arguably the more frequent alternative in Norwegian. Let

³ I will primarily use the terms *directional* and *metaphorical* here, although *predicational* (or *predicative*) and *idiomatic* are more established terms in the literature. Since the two latter terms imply a given analysis to a greater extent (*predicational* technically means a small clause analysis, and *idiomatic* implies a formalised idiom formation), I will stick to the more descriptive terms *directional* and *metaphorical* until further notice. But note that the *directional/predicational* alternative need not be directional in all cases:

- (i) halde {ute} hunden {ute}
hold {out.LOC} the dog {out.LOC}
‘keep the dog outside’

We will return to the *metaphorical/directional* distinction in 1.1.2.

me from now on refer to a right-distributed particle like in (1a) as *RPr*t, and to a left-distributed particle like in (1b) as *LPr*t.

Thus far, I have made two basic claims that have both a theoretical and empirical flavour; these two claims constitute my overall working hypothesis:

(2) Working hypothesis

LPrt and RPrt constructions are semantically distinct, and the LPrt construction is the unmarked, preferred, and more frequent alternative in Norwegian.

In the research community up to now, there have essentially been two ways of approaching Norwegian VPrt constructions: one is associated with theoretical linguistics and the other with a more traditional dialectological approach.

In the linguistic literature (e.g., Taraldsen 1983, Åfarli 1985, den Dikken 1995, Svenonius 1994, 1996a, 1996b, Zeller 2001, Ramchand & Svenonius 2002), the idea of optional particle distribution has generally been taken for granted, and typically (1a) and (1b) are derived by movement – of the particle, of the DP, or both. Some argue for quite similar, equally economical derivations (see, e.g. Svenonius 1996b), while others develop quite different derivations of LPrt and RPrt constructions (e.g., Taraldsen 1983, den Dikken 1995, Zeller 2001).

In the Norwegian traditional and dialectological literature, the LPrt preference has been well known for a long time, dating back to Aasen (1848, 1864). Later on, it was mentioned by Western (1921), Sandøy (1976, 1985), and also by Faarlund (1977). Sandøy (1976) produced arguably the most elaborate Norwegian empirical work on VPrt, emphasising the LPrt preference in the Romsdal dialect (North-West Norwegian), as well as the difference between directional and metaphorical constructions.

I will take the traditional and dialectological approaches as my starting point, and by including more recent dialectological material (see section 1.4 and chapter 2), I hope to find out whether the hypothesis in (2) holds, or whether the particle alternation is actually as free as indicated by the linguistic literature. This is an essential research question (RQ) that I hope to give a satisfactory answer.

RQ 1: Is it the case that LPrt and RPrt constructions are semantically distinct and that LPrt constructions are generally preferred in Norwegian, and what do the semantic and grammatical differences consist in more precisely?

To my knowledge, no earlier work in theoretical linguistics has taken the LPrt preference hypothesis into account, and therefore an empirical evaluation and critique of earlier linguistic approaches is necessary. This will be done in chapter 3.

The hypothesis in (2) contains the essential ingredients in my syntactic analysis that will be developed in the first section of chapter 4. Very briefly, I hypothesise that (1a) represents the basic word order from which the word order in (1b) is derived. The basic derivation is one of semantically driven leftward particle movement, which explains the difference in meaning between LPrt and RPrt constructions. These hypotheses constitute my basic answer to the following research question.

RQ 2: What is the nature of the syntactic structure and derivation regarding Norwegian VPrt constructions?

However, as already mentioned, from section 4.3 onwards, the traditional generative derivational analysis will be challenged. In this part, I will use the VPrt data to figure out whether differences that are traditionally considered structural in the generative literature should be explained in more general semantic terms, i.e., on a non-linguistic level. Thus, a theoretical ambition of the work is to explore both the syntax–semantics interface and also the interplay between the structural, lexical and non-linguistic semantics. Thus, my third basic research question is the following.

RQ 3: How can the interplay between structural, lexical and non-linguistic meaning best be integrated in an analysis of Norwegian VPrt constructions?

1.1.2 More Norwegian Data to Be Considered

I have formulated some general empirical and theoretical questions above. In this section, I will formulate more research questions that concern the empirical diversity that I will explore, more elaborately. Consider the directional–metaphorical distinction mentioned above. In metaphorical constructions (where no directionality compatible with the basic semantics of the particle is expressed), LPrt is not only preferred, but obligatory for some speakers. The following examples are taken from Sandøy (1976: 108) and the Romsdal dialect:

- (3) a. Han las opp brevet.
 he read up the letter
 ‘He read the letter loudly’
- b. *Han las brevet opp.
 he read the letter up
 ‘He read the letter loudly’

I will attempt to uncover why the LPrT preference is even stronger here than in directional constructions, and what the technical difference between (1b) and (3) is, e.g., whether (3) is a result of some kind of idiom formation (cf. Bruening 2010). The distinction between directional and metaphorical constructions is essential.

RQ 4: How should the syntactic and semantic differences between directional and metaphorical structures be modelled in an analysis of Norwegian VPrt constructions?

It will also be noted that the distribution of the particle is apparently affected by the presence of an additional resultative PP complement, which more easily allows RPrT. From Sandøy (1976: 105) (Romsdal Norwegian):⁴

- (4) a. +Han bar fangst’n sin ut åt dei fattige.
 he carried the catch REFL out to the poor
 ‘He carried his catch out to the poor’
- b. ?Han bar ut fangst’n sin åt dei fattige.
 He carried out the catch REFL to the poor
 ‘He carried out his catch to the poor’

⁴ Sandøy (1976) uses a plus sign (+) to mark the preferred alternative, when more alternatives are possible. That is, when the dispreferred alternative is grammatically marginal, the conventional question marks are used. I will follow Sandøy by using this kind of marking. However, when the dispreferred alternative is fully acceptable from a grammatical point of view, but just sounds more awkward, I will use a minus sign (–). The minus sign will generally be used in the context with a plus sign, so it is not confused with a dash.

In section 4.4, I will discuss what actually causes the RPrt to be preferred in (4), contrary to what is hypothesised in (2). The question is whether the PP in the right-periphery carries an influence on the particle distribution and in case why.

RQ 5: Why is the RPrt pattern generally preferred when there is an additional resultative PP complement to the VPrt?

While one can speak of *preferred* and *dispreferred* particle positions for the data discussed so far, there are also some VPrt constructions where RPrt distribution is usually not possible. (5) does not fit in the standard pattern shown in (1).

(5) a. Han skrapa av ruta.

he scraped off the windshield

‘He scraped (the ice) off the windshield’

b. */??Han skrapa ruta av.⁵

he scraped the windshield off

In the meaning given in the translation of (5a), the DP *ruta* ‘the windshield’ in (5b) cannot be construed as a SC subject. But most likely, it will be construed as what we may refer to as a *Ground* (and not *Figure*) element (cf. Talmy 1972, 1985, 2000, Svenonius 1996a). The Figure will in the VPrt case correspond to the SC subject, while the Ground will refer to where the Figure is located (e.g., the SC predicate). Figure and Ground can be characterised as a located and a locating entity, respectively, the former denoting a moving or conceptually movable entity, and the latter a stationary reference entity (cf. Talmy 2000: 312).⁶ Constructions like (5), where the DP is construed as Ground, are named Group 2 kind of VPrt constructions by Ven (1999), as opposed to Group 1, which corresponds to the standard type in (1) and (3). In chapter 5, I will discuss the Group 2 constructions and how they relate to Group 1 both syntactically and semantically. The most important questions are whether the semantic

⁵ This particular example can occur as a standard RPrt construction if the window is understood to be scraped off something else (e.g., that it has loosened from the car as a result of too much scraping).

⁶ Talmy’s (2000: 312) complete definition goes like the following:

“The general conceptualization of Figure and Ground in language

The Figure is a moving or conceptually movable entity whose path, site, or orientation is conceived as a variable, the particular value of which is the relevant issue.

The Ground is a reference entity, one that has a stationary setting relative to a reference frame, with respect to which the Figure’s path, site, or orientation is characterized.”

observations here (cf. the Figure/Ground distinction) should be reflected in the structural representation (which is the obvious option given a traditional derivational approach), or whether the semantic difference between Group 1 and 2 is a general-conceptual difference, unrelated to structure. The latter solution is an option in the representational model that we will explore, and I will elaborate upon these differences in chapter 5.

RQ 6: How should the so-called Group 2 VPrt constructions be analysed in order to account for their basic syntactic and semantic differences as compared to Group 1 VPrt constructions?

Consider next the data in (6), where the particle combines with an unaccusative verb (cf. Perlmutter 1978, Burzio 1986):

- (6) a. Han gjekk på bussen.
he went on the bus
'He entered the bus'
- b. *Han gjekk bussen på.
he went the bus on
- c. Det gjekk {på} nokon {på}.
it went {on} someone {on}
'There was someone entering the bus'

As was the case in (5), the associated DP *bussen* 'the bus' in (6a) is a Ground and not a Figure DP, thus the RPrT distribution in (6b) is impossible. But interestingly, the particle can alternate as in Group 1 constructions in the impersonal variant in (6c). (6) can therefore be directly compared to both Group 1 and 2. In the personal variant in (6a), it is traditionally assumed that the matrix subject is merged lower, specifically in the SC subject position, and raises. I will discuss different types of unaccusative VPrt constructions (including weather constructions) in chapter 5, and this extension of the Norwegian VPrt data will hopefully shed new light on how VPrt constructions in general should be treated theoretically. To my knowledge, the unaccusative VPrt constructions have not been thoroughly discussed in Norwegian before.

RQ 7: What are the basic structural properties of unaccusative VPrt constructions, and can their basic properties be assimilated to the properties of either Group 1 or Group 2 VPrt constructions?

By relating the unaccusatives to both Group 1 and Group 2 constructions, my aim is again to explore what semantics is structurally founded, and what semantics is unrelated to structure. In sum, chapters 4 and 5 will try to answer the following question: What is the most rational theoretical generalisation of the three relevant groups of VPrt constructions?

The semantics of the particle is also interesting; I will discuss some particles quite briefly (such as *ut* ‘out’), and some more thoroughly (such as *opp* ‘up’). However, the most important particle/preposition to be discussed in this thesis is *med* ‘with’. This will be done in chapter 6. The reason why *med* is interesting is that it generally allows more complex complements than other prepositions (Jespersen 1924, 1940, Bech 1998, Aa 2004, 2006, Anderson 2010). Thus, a VPrt construction introduced by *med* can be more complex than one introduced by, e.g., *på* ‘on’:

(7) Johan tok med ned boka.

John took with down the book
‘John brought the book down’

(8) Johan tok på (*ned) hatten

John took on (down) the hat
‘John put on the hat’

In this thesis, I will build on the abovementioned works on *med*, and conclude that its special basic semantic property of juxtaposing two elements can contribute to explaining both the complex PPs discussed in previous works and the complex VPrt construction in (7). While prepositions like *på* ‘on’ and *i* ‘in’ generally arrange a Figure–Ground constellation, I will argue that the special property of *med* entails a Figure–Figure constellation. That is to say, *med* facilitates the arrangement of two subject-like DPs. In section 1.2.2, I will suggest that the lexical properties of a verb do not bear any influence on the syntactic structure. An important question in chapter 6 is whether this observation also holds for the lexical semantics of prepositions, or whether the P semantics actually influences the syntax to a greater extent.

RQ 8: Why does *med* ‘with’ used as a VPrt license a more complex structure than do the other VPrts, and what are the syntactic and semantic properties of VPrt constructions involving *med* ‘with’?

Finally in this section, I will briefly mention three important phenomena that I will *not* be able to discuss in the thesis. The first one concerns *light pronoun constructions*. These show an interesting pattern in East and Central Norwegian dialects, with the particle to the left of the light pronoun (see e.g. Aasen 1848: § 335 and Sandøy 1985: 102), differing from the standard Norwegian pattern that is typically presented in the generative literature (see e.g. Thráinsson 2007: 34, 142). Some of Aasen’s data are given in (9).⁷

(9) **East and Central Norwegian:**

- a. Dæm åt upp det.
they ate up it
‘They ate it up’

- b. Dæm kasta ut ‘en.
they threw out him
‘They threw him out’

- c. Kast inte burt det.
throw not away it
‘Don’t throw it away’

Although the interaction between light pronouns and particles is highly interesting, light pronouns constitute a separate and independent theme of study that is not directly relevant to the analysis of particles as such. Moreover, light pronouns raise issues that for reasons of space cannot be discussed here. For the same reason, I will not discuss *participle constructions*. These show interesting patterns regarding the possibility of a particle to incorporate into the participle, and regarding participle agreement (see e.g. Sandøy (1988) for

⁷ *Nynorsk* was not standardised by the time of 1848 (see section 1.1.4), and Aasen’s (1848) rendition of the examples is strongly flavoured by the respective dialects, i.e., Central Norwegian in (9a, b) and East Norwegian in (9c).

the agreement patterns, and Svenonius (1996a) and Aa, Eide & Åfarli (2014) for a discussion of agreement and incorporation possibilities). Again, a proper analysis of participles would demand too much space to be included here.

In addition to light pronoun and participle constructions, I will not prioritise to investigate *adjectival VPrt constructions*, although they too show an interesting contrast between LPrT and RPrT distribution, and also between agreement vs. non-agreement in the right- vs. left-hand position.⁸ I will refer to Sandøy (1976: 91ff) for interesting data from Icelandic, Faroese and Romsdal Norwegian, and to Åfarli (1985: 91) for data from the Halså dialect (western *Trøndsk*).

1.1.3 Norwegian in a Scandinavian Perspective

Primarily, the present work is a study of VPrt constructions in spoken *Norwegian*. The syntax and semantics of the various particle constructions in the dialects of spoken Norwegian are therefore the main concern of the thesis.

Focusing on the Norwegian dialect area to the exclusion of other Scandinavian dialects may apparently seem difficult to justify methodologically, but I will argue that the new Norwegian dialectal material collected in recent years uncovers more variation than known previously (see e.g. the discussion on the Nordic Dialect Corpus (Johannessen et al. 2009) in section 1.4.3.2), and thus makes it natural to narrow down the language area in focus. Since Platzack's (1987) investigations of the null-subject parameter across the Scandinavian languages, and subsequent joint work with Anders Holmberg on the AGR parameter, the Insular (ISc) and Mainland Scandinavian (MSc) languages have been considered as a dialect continuum rather than different languages. As Johannessen et al. (2009: 74) point out, there is mutual intelligibility within MSc, and within ISc – and some mutual intelligibility between MSc and ISc, at least between the written forms.⁹ This is one of the motivations for

⁸ Generally, the right-hand adjectival particle agrees to a greater extent with the associated DP than the corresponding left-hand variant (Heggstad 1931: § 609). But there is variation between the dialects, and apparently between the concrete adjectives. In English, left-hand adjectives seem more lexically restricted (Svenonius 1996a), but Åfarli (1985) provides data showing that Norwegian seems to differ from English in this respect. Importantly, the distribution of adjectives does not seem to follow the rules of prepositional particles.

⁹ When we define dialects as separate language systems (see section 1.3), i.e., with separate grammars and inflectional systems, it follows that each and every dialect is a separate language. Thus, it becomes less important whether we cross political borders or not in a comparative study. The presence or absence of mutual intelligibility must be considered a “popular” diagnostic for the dialect vs. language distinction, in the same way as a separation by political borders. Principally, two dialects are grammatically closely related language systems, and non-linguistic factors such as common vocabulary and mutual intelligibility are more random and vary individually to a greater extent. We will stick to a linguistic understanding of languages here.

developing a Nordic dialect corpus (see 1.4.3.2). Although my main focus will still be on Norwegian, the Scandinavian micro-comparison will be more prominent in the latter sections of chapter 4. In 4.5, I discuss the case of Swedish in relation to the analysis I have just developed for Norwegian in sections 4.1–4.4. I will try to elucidate the following research question.

RQ 9: Why and to what extent are Swedish VPrt constructions structurally different from Norwegian ones, and how could the differences be analysed structurally?

Then in 4.6, I explain the Norwegian particle alternation with an alternative approach, i.e., in terms of bilingualism (cf. Hoekstra 1992, den Dikken 1992). More concretely, I suggest that the particle alternation in written Norwegian may be the result of the mix-up between the grammar of spoken Norwegian (LPrt) and written Danish (RPrt). This is hypothesised as the result of the massive Danish influence on written Norwegian from the 16th century onwards (cf. Berg 2013 and see section 1.1.4). The research question that I will seek to briefly elucidate is the following.

RQ 10: Is it possible that the contemporary Norwegian VPrt patterns can be the historical outcome of the influence of the Danish VPrt pattern on a traditional domestic Norwegian pattern?

I will not be able to answer RQs 9 and 10 in full, but I want to do some initial investigations that hopefully can constitute a starting-point for more comprehensive future research.

As we will see in chapter 2, Norwegian is traditionally claimed to occupy an intermediate position within MSc in many respects, e.g., concerning the word order in VPrt constructions and *la* ‘let’ causatives. (10)–(12) present the commonly known MSc typology for these two constructions. (10)–(11) are taken from Vikner (1987), (12) is constructed in line with Taraldsen’s (1983) claim for Norwegian.¹⁰

From now on, I will follow Svenonius (1994, 1996a) by using curly brackets {...}₁, {...}₂, to mark that 1 and 2 alternate, and never occur together (we get *either* 1 *or* 2). Round brackets (...)₁, (...)₂ usually (e.g., in dictionaries) indicate a possible simultaneous appearance of both 1 and 2, or even a possible absence of both.

¹⁰ Taraldsen presents the pattern in (12) as Norwegian, but it is not specified what kind of Norwegian. Since he transcribes his examples to *Bokmål*, I have noted that explicitly in (12).

- (10) a. **Danish:** Peter lod {*støvsuge} tæppet {støvsuge}.
Peter let vacuum-clean the carpet
‘Peter vacuum-cleaned the carpet’
b. **Danish:** Peter smed {*ud} tæppet {ud}.
‘Peter threw out the carpet’
- (11) a. **Swedish:** Peter lät {dammsuga} mattan {*dammsuga}.
Peter let vacuum-clean the carpet
‘Peter vacuum-cleaned the carpet’
b. **Swedish:** Peter kastade {bort} mattan {*bort}.
‘Peter threw out the carpet’
- (12) a. **Norw. Bokmål:** Peter lot {støvsuge} teppet {støvsuge}.
Peter let vacuum-clean the carpet
‘Peter vacuum-cleaned the carpet’
b. **Norw. Bokmål:** Peter kasta {ut} teppet {ut}.
‘Peter threw out the carpet’

This overview represents the traditional “linguistic” claim. Danish has always RPrT, as shown in (10b), and also has the infinitive right-handed (10a). For Swedish, the pattern is the opposite, as in (11), and then Norwegian can apparently switch between the two, as in (12). However, the hypothesis in (2) questions optionality in (12b). And although it is not of importance at this stage, it should be noted that (12a) is not really a comparable construction, since it is not productive in spoken Norwegian.¹¹ The important point is that the LPrT

¹¹ Svenonius (1994: 181) notes one particular example from Taraldsen (1983: 203) to be a frozen form:

- (i) De lot {mannen} sette krone på {mannen}.
they let {the man} set crown on {the man}
‘They had the man crowned’

In my view, both (i) and (12a) above are conservative *Bokmål* constructs, probably adopted from Danish. While VPrT constructions are productive in both speech and writing, I have never heard a Norwegian produce a la ‘let’ causative of the (12a) type, and I have rarely seen it in written sources except linguistic literature. However, la ‘let’ causatives are highly productive with *seg* reflexives, in which case the infinitive appears to the right of the light reflexive pronouns:

- (ii) Han lét seg ikkje påverke.
he let REFL not affect
‘He was unaffected’
(iii) Han lét seg sjeldan imponere.
he let REFL rarely impress

preference hypothesis given in (2) questions the general status of Norwegian as occupying an intermediate position within the MSc picture.

1.1.4 *Some Notes Concerning the Norwegian Language Situation – and My Rendition of Norwegian Examples*

Political and social issues are not essential in this thesis, but I will clarify some basic points concerning the Norwegian language situation. First, there are two official Norwegian written standards, *Nynorsk* and *Bokmål*. With an extended dialect fieldwork lasting over many years in the 1840s, Ivar Aasen (1813–1896) formed the basis of a new written standard, i.e., *Nynorsk*, based on the rural dialects in Norway. His first attempt to standardise the language is found in *Prøver af Landsmaalet i Norge* ‘Specimens of Norwegian Country Speech’ in 1853; later, he published two important standardisation milestones: a prescriptive grammar (Aasen 1864) and an extended dictionary (Aasen 1873) (compared to his first dictionary, Aasen 1850). Until 1929, the language was known as *Landsmål* ‘The Country’s Language’, but the name was replaced by *Nynorsk* ‘Modern Norwegian’ from that year on.¹²

The *Bokmål* standard has developed from Danish, which was the language that was regularly written in Norway from the 16th century onwards (Berg 2013: 199ff, cf. Indrebø 1947: 30f) (see section 4.6.3 for more details on this). From the 15th century onwards, Norway was part of different Nordic unions, and cleared its independence from a long-lasting union with Denmark in 1814. Danish was still the only official written language in Norway also for many years after the dissolution. In 1885, there was a resolution that officially put Aasens’ *Nynorsk* (*Landsmål*) on equal footing with *Bokmål*/Danish (known as *Riksmål* from the 1890s to 1929). Also, beginning in 1907, *Bokmål* was eventually “norwegianised” by incorporating many of Knud Knudsen’s (1812–1895) important norm suggestions (cf. Torp & Vikør 2003: 201ff). Throughout the 20th century, the official Norwegian language policy aimed to assimilate the two standards into a common one (*Samnorsk* ‘Common Norwegian’). However, this turned out not to be successful, and the idea was officially abandoned in 2002.¹³

‘He was rarely impressed’

¹² Haugen (1933 [1972: 25, footnote 1]) uses the term *New Norse* for *Nynorsk/Landsmål*, “because it emphasizes the descent of Landsmaal from Old Norse and because it does not, like “Nynorsk”, beg the question by claiming to be the only modern Norwegian language.” For the readers not capable of reading Norwegian, Haugen (1933), which is an extract from his 1931 dissertation, gives a nice overview over the early development of the *Nynorsk* language.

¹³ See a short article on *Samnorsk* in *Store norske leksikon*, <<https://snl.no/samnorsk>> (accessed October 2014).

The majority of writers has always had *Bokmål* as their first official language; the percentage of *Nynorsk* writers peaked in 1944 with 34,1%, but already by 1965 it had decreased to 20% (Torp & Vikør 2003: 207). In 2011–2012, 12,8% of the pupils in elementary school in Norway had *Nynorsk* as their first official language, but the number is still generally decreasing (Almenningen & Søyland 2012: 13);¹⁴ only Sogn og Fjordane county in the west (with 2% of Norway’s population) has a clear and stable majority of *Nynorsk* writers (97% of the pupils in elementary and secondary school wrote *Nynorsk* in 2010; see Grepstad 2012).

Despite of the decline of the number of *Nynorsk* writers, the status of the spoken varieties has increased significantly over the last 50 years.¹⁵ While in the 1960s and 70s it was unthinkable to give a university lecture on a local dialect, that is rather the standard today. Furthermore, the dialects are heard in the media to a greater degree than before, e.g., in the news and in children’s TV. To my knowledge, there is no serious public or formal arena today where the use of dialects is considered unacceptable. Due to the general increase of migration most people are exposed to multiple dialects every day (cf. Vulchanova et al. 2012), which is also generally assumed to contribute to the higher degree of acceptance of the spoken varieties than before.¹⁶

As mentioned in footnote 1, I will by default render my Norwegian examples in *Nynorsk*; a non-specified Norwegian example is therefore given in *Nynorsk*. When I use a dialectal example (e.g., from *Norsk Ordbok*, see section 1.4.4) I will also render this in standard (or in dialect-coloured) *Nynorsk*, which hopefully makes it easier to understand for those not having Norwegian as their first language, but who are capable of reading Norwegian. When I render a *Bokmål* example, this will be specified explicitly. *Nynorsk* is the standard that lies closest to most Norwegian spoken varieties, and therefore I think it is the natural standard to use in a work like this. When I reproduce examples from other linguistic works, I will of course render the examples in the standard used in the relevant works.

¹⁴ The exact number is taken from the Norwegian Language Council’s annual report on the status of the Norwegian language, 2012 (<<http://sprakradet.no/Tema/Spraakpolitikk/Sprakstatus/Sprakstatus-2012/>>, accessed September 2014). Almenningen & Søyland (2012: 13) report 13%, and they also give a brief summary of the position of *Nynorsk* in the Norwegian society today.

¹⁵ This has been emphasised in a lot of contexts. A late example is by the director of *Stiftelsen Fritt Ord* ‘The Freedom of Expression Foundation’, Knut Olav Åmås, in *Aftenposten*, December 21, 2014. Åmås claims that dialects have authority today compared to earlier (see <<http://www.aftenposten.no/meninger/kommentarer/Knut-Olav-Amas-Sprak-til-salgs-7832876.html>>, accessed December 2014).

¹⁶ Mæhlum & Røyneland (2009: 227) also claim that the status of the dialects generally high in Norway, but there are some important modifications discussed in their article. Despite of the general dialect levelling and regionalisation of dialects (especially in the East Norwegian dialects close to Oslo), an “exaggerated” accommodation of one’s dialect (e.g., to a more regional/urban variant) is generally not well accepted (see also Bull 2009 for a similar conclusion). Thus, there are still social norms for the dialect speakers.

Taraldsen's (1983) (see section 3.1) examples are in *Bokmål*, while Åfarli's (1985) (section 3.2) and Sandøy's (1976) examples are mainly in *Nynorsk*. Åfarli and Sandøy also give examples from their respective dialects (of Romsdal and Nordmøre), and these are either rendered in standardised or a dialect-coloured *Nynorsk* in their works.

1.2 The Theoretical Framework

This section will highlight the general theoretical basis for the thesis with an emphasis on the syntax of VPrt constructions. Specific approaches to VPrt, specifically earlier theoretical accounts, will be discussed in chapter 3, and my own analysis will be developed in detail in chapters 4–6. In this section, the focus is on the general theoretical framework.

The theoretical basis for the analyses presented throughout this thesis is generative grammar. Generative grammar was introduced by Noam Chomsky's work in the 1950s (Chomsky 1955, 1957), and has continuously developed since. The early generative theory criticised the behaviouristic approach to language, which was especially concretised with Chomsky's (1959) relentless review of Skinner's (1957) *Verbal Behavior* (Seuren 1998: 251f). Instead, language was approached as a cognitive capacity of the speaker (cf. Lasnik & Lohndal 2013: 27). From Chomsky (1965) onwards, the question of how the speaker acquires language became more important (Lasnik & Lohndal: loc.cit.), and thereby the paradox known as "Plato's problem", which we may paraphrase as follows: How does the child learn a language so fast with so little and unsystematic input? The answer to this question was the theory of Universal Grammar (UG), which hypothesised a biologically predisposed language faculty in the mind of the speaker. UG contains a set of open categories, which is fixed through experience. This is the opposite of believing that the child meets the language as a blank slate, which would make the complexity of any language impossible to acquire.

In the 1980s, the acquisition and variation of languages were analysed in terms of the theory of Principles and Parameters (P&P) (cf. Chomsky 1981). In the early P&P theory, UG was assumed to consist of an absolute and invariable part, common to all languages (the principles), and an open part, which would have its values fixed by experience (the parameters).¹⁷ In the 1980s, P&P was implemented by the Government and Binding (GB) Theory (Chomsky 1981), and from the 1990s onwards by the Minimalist Program (MP) (Chomsky 1993, 1995). In the MP, the parameter term has changed slightly; nowadays, most

¹⁷ P&P will be discussed more elaborately in section 1.3.

linguists do not believe that the syntactic module of UG is parameterised (cf. Barbiers 2013: 903f). This will be discussed in section 1.3.

Throughout the work, I will aim for a close interplay between the theory and the data, and I place my work in the P&P tradition; most of the theoretical-linguistic work that it relates to is from the P&P era. In section 1.2.1, I will outline some general generative and Minimalist principles, as well as the restrictions imposed by *Phrase Structure* vs. *Bare Phrase Structure* (BPS). In section 1.2.2, I will promote a syntactic exoskeletal frame model with late lexical insertion. Although the discussion will be on a general theoretical level in this sub-section, it will also be oriented towards the specific particle data.

1.2.1 *Generative Grammar and (Bare) Phrase Structure*

Within generativism, there is an ambition to seek uniformity and similarities between languages, rather than to describe the diversity that we observe. This is a consequence of the universal aspects of language being the primary goal of study, rather than variation. Consider the following quote from Barbiers (2013: 899):

The central hypothesis of GG [generative grammar] is that underlying the wealth of cross-linguistic syntactic variation there is a core of syntactic principles that are universal and innate, so-called Universal Grammar (UG). Language-specific grammars are the result of the interaction between these UG principles and the linguistic environment, i.e. the linguistic input during the process of language acquisition.

When we claim that languages vary systematically from a common core and are more similar than what can be observed on the surface, we must assume similarity at an abstract level. This can be considered a basic idea of derivational grammars.

The standard assumptions regarding derivational processes in generative grammar have changed a lot over the years since Chomsky (1955, 1957).¹⁸ In the Standard Theory developed in Chomsky (1965), the derivations were construction-specific. The sentences in (13) would be derived from a common Deep Structure (DS)¹⁹ (expressing the basic proposition that John is the agent and Mary the patient of the seeing). A passive

¹⁸ A brief but nice and clarifying overview of the development from the 1950s onwards is provided by Lasnik & Lohndal (2013).

¹⁹ The DS interface level was introduced in Chomsky (1965), in order to get “a simpler overall theory, and at the same time it explained the absence of certain kinds of derivations that seemed not to occur” (Lasnik & Lohndal 2013: 34).

transformation rule would work in order to get (13b), and an interrogative transformation rule in order to get (13c).

- (13) a. John saw Mary
 b. Mary was seen by John.
 c. Did John see Mary?

The different semantic interpretations that followed from the transformations to the concrete sentence types would apply at the interface level of Logical Form (LF). Thus, the Standard Theory operated with two semantic interface levels, DS and LF.²⁰

In GB Theory (Chomsky 1981), the construction-specific rules were replaced by the generalised rule *Move alpha*, a rule that implied that “everything” could move “everywhere”. Thus, the restrictions of movement were crucial, and these restrictions were formulated either as general or parameterised principles. The result was a more uniform transformational theory with a P&P architecture. GB theory operated with a four-level model of grammatical representation: Deep Structure (DS), Surface Structure (SS), Phonetic Form (PF), and Logical Form (LF).²¹ The so-called “T-model” of levels of representation was proposed by Chomsky & Lasnik (1977), cf. (14).

(14) **The T-model in GB Theory**

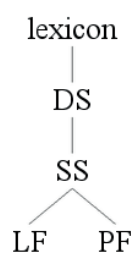

The T-model suggests an early lexical entry, upon which the syntactic structure is built. DS is the level where e.g. *John* and *Mary* in (13) get their thematic (Theta) roles as agent and patient, respectively. DS is also where the derivation starts; it is “the output of phrase-structure operations and plus lexical insertion and the input to transformational operations” (Hornstein et al. 2005: 21). At the level of SS, the derivation splits into the sound and

²⁰ See a basic overview (in Swedish) in Platzack (2010: 46ff).

²¹ See a brief overview in Hornstein et al. (2005: 19ff).

meaning levels, PF and LF, and sends a copy to each of them. SS is also the level at which many of the GB modules (such as Case assignment) work, and where much parametric language variation is explained. Movement from DS to SS is overt, and movement from SS to LF covert (Hornstein et al. 2005: 22f). Only the former of these movements will have a copy sent to PF, and is therefore overt. A famous example of this distinction is the verb-movement to I (V-to-I-movement), which is assumed to apply before SS in French and after SS in English) (cf. Chomsky 1995).

Chomsky considers sentences to be the central linguistic unit, and sentences are basically pairings of sound and meaning (cf. Boeckx 2006: 73f). PF and LF are therefore necessary interface levels, since the grammar model must at least take the sound and meaning components into account. In the light of this, the T-model is conceptually redundant, since it includes two semantic levels, DS and LF. With the launch of the MP, Chomsky (1993: 19ff) aims to get rid of the superfluous levels in the T-model; he argues that both DS and SS should be dispensed with, since they are theory-internally motivated. The MP therefore implies a more minimal grammar model, which only consists of the two necessary interface levels, LF and PF.

Hornstein et al. (2005: 48ff) give empirical support to the MP model. First, they show how control and raising constructions (pp. 50ff) can be derived without postulating a DS level, where Theta roles were traditionally assigned. Instead, they assume that Theta roles are assigned under the *Merge* operation (see below) (cf. the Theta Role Assignment Principle (TRAP), p. 54), and not by movement (a DP cannot move in order to get its Theta role). Assuming these standard operations the control and raising constructions are derived straightforwardly without extra devices, compensating for the loss of DS.

As mentioned, SS is the level where Case is assigned in the T-model. However, by replacing assignment with a *checking* mechanism (see below), Hornstein et al. (2005: 26ff) show how SS can also be dispensed with, by assuming that the Case filter can apply at LF (and still have consequences for PF). I refer to their relevant passage for further discussion.

I have already introduced minimalist terms such as *Merge* and *checking*, but I have not explained them. Thus, I will continue by discussing a basic minimalist derivation. In the early standard MP model (Chomsky 1993, 1995), syntactic structures are built in a bottom-up fashion with the operations *Merge* and *Move* (*Internal Merge/Remerge*). *Merge* is a basic operation which allows two elements to combine in a binary fashion, with one element merging to the edge of the other. Consider the transitive sentence (15). In addition to the word

order, the model must explain e.g. *Mary*'s Accusative Case, and *John*'s Nominative Case (a substitute test with pronouns demands an overt Case marking: *He_{NOM} saw her_{ACC}*).

In (16a), the verb merges with the object DP and creates the new level V'. *Mary* is now in the *complement* position of *saw*, which heads the verbal phrase. In (16b), V' merges with *John*, which creates the new level VP. *John* is now in the *specifier* position of the VP (Spec,VP). In (16c), VP merges with I and creates I'. *Saw* is remerged. Then in (16d), *John* is remerged with I', which creates the new level IP.

(15) John saw Mary.

(16) a. *saw* + MERGE *Mary*

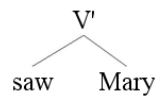

b. V' + MERGE *John*

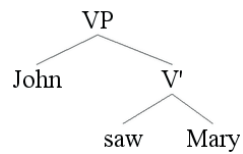

c. VP + REMERGE *saw*

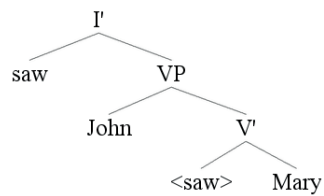

d. I' + REMERGE *John*

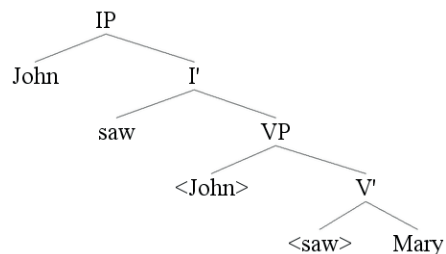

From what is said further above (cf., TRAP), *Mary* gets the internal Theta role when merged with *saw*. And *John* gets his Theta role when merged with V' . (16) shows a rather simplified derivation, and I have not made the Case operations explicit. In early MP (Chomsky 1995), *Mary* has the Accusative Case checked against *saw*, so that the Case features are deleted by LF. In order to check the Nominative Case, *John* must remerge in Spec, IP and have the features checked against the relevant feature in I (e.g. in a Spec-head configuration). Likewise *saw* is remerged in I to have its tense features checked against the corresponding features in I.

In more recent MP versions, the features are checked²² with a quite different apparatus. Since Chomsky (2000, 2001), the standard assumption has been that Case is licensed by a probe–goal relation between a head and a DP. The probe–goal relation is described as follows by Hornstein et al. (2005: 317):

A probe is a head with [–interpretable] features and a goal is an element with matching [+interpretable] features. In order to have its [–interpretable] features deleted for LF purposes and specified for morphological purposes, a given probe peruses its c-command domain in search for a goal. A goal is accessible to a given probe only if there is no intervening element with the relevant set of features; that is, relativized minimality holds.

In (16), we must then assume that V has [–interpretable] (i.e., unvalued) Case features that need to be valued or deleted. V then *probes* its c-command domain²³ in search of an element with matching [+interpretable] Case features, and in this way its own Case features get valued.²⁴ Since DPs can have Case morphologically realised, we can assume that a [+interpretable] Case feature is found on them. Hence, the closest DP (cf., Relativised Minimality, Rizzi 1990) will be the goal for V 's Case probe and the element that matches and values V 's Case features. In (16), the base position of *Mary* is found within V 's c-command domain.

Some features need to be valued/checked overtly. Nominative Case is such a feature, as it is strongly associated with the subject position of the clause, Spec,IP. We can assume that Spec,IP has an unvalued *EPP* feature,²⁵ which needs to be checked overtly (i.e., by remerge/movement of a DP).

²² Other terms for *checking* are *valuing*, *deletion*, and *elimination*.

²³ The definition of c-command goes as follows in Chomsky (1995: 35): “ α c-commands β if α does not dominate β and every γ that dominates α dominates β .”

²⁴ In some sense, this actually seems counter-intuitive, i.e., that the verb gets Case by being valued, cf. the traditional idea that the verb assigns Case.

²⁵ The EPP (= the Extended Projection Principle) was introduced by Chomsky (1982: 10) as an extension of the Projection Principle (cf., Haegeman 1994: 55). EPP was originally a requirement that all sentences have subjects. However, in more modern theory, it is referred to as a general principle when overt movement to a Spec position is required (cf., Platzack 2010: 78).

I mentioned above that a recombination of an already-merged element is called Internal Merge or Rmerge. Rmerge is not movement in a technical sense, but a mechanism by which an element is copied, typically to a position higher in the structure (as of *saw* from V to I in (16c) and of *John* from Spec,VP to Spec,IP in (16d)). Using a copy operation rather than a trace-leaving movement (as was the standard in GB), ensures that no lexical items are added or removed in the transformation. The lexical items that are available for the derivation are usually referred to as a *Numeration* (Chomsky 1995: 225). The *Inclusiveness Condition* allows the structure only to be built from the lexical items of a Numeration (Chomsky 1993, Hornstein et al. 2005: 74). Since a trace does not exist in the lexicon and is not taken from the Numeration, it must be added in the derivation and hence violates the Inclusiveness Condition.

As mentioned, a new item in the structure merges to the “edge” of an already-merged element (cf. Platzack 2012). The *Extension Condition* is what “guarantees cyclicity” of the derivation (Chomsky 1995: 327), in that the Merge/Rmerge operation only applies to a root syntactic object (= the “edge”), i.e., “a syntactic tree that is not dominated by any syntactic object” (Hornstein et al. 2005: 62). In (17), this means that the new syntactic object RP must merge with KP (to create QP), and *not*, e.g., with LP. LP is dominated by KP and is therefore not a root syntactic object.

(17)

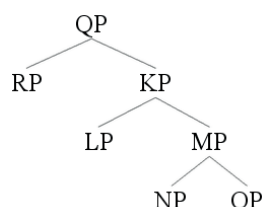

Even though the Minimalist Program redefines many of the derivational notions and mechanisms as indicated above, I will still use the traditional terms (*particle*) *movement* and (*particle*) *shift* in my discussion, since these are well established in the relevant literature. However, I will not use traces in my own analyses (other than when the discussion is tightly connected to the GB literature). When I refer to movement (for reasons of convenience, e.g., when discussing a GB work), it can therefore technically be interpreted as rmerge (the discussion and analysis of movement can be translated into MP terms and principles without effort). Particle movement is analysed as a *head movement* operations in many works (see e.g.

the discussion on Svenonius 1996a in section 3.4, and on Ramchand & Svenonius 2002/Ramchand 2008 in section 3.6). Head movement is the movement of an X (and not XP) element, cf. (18). In (16), *saw* is merged in V (16a) and remerged in the closest head position, I, in (16c). This is a syntactic head movement. However, Bobaljik & Brown (1997: 347) claim that head movement violates the Extension Condition, cf. the V-to-I-raising in (16):

Under standard assumptions, the head V cannot raise to I⁰ until I⁰ is in the same phrase marker as the V – that is until after merger of I⁰ and VP creates the I' or IP node. However, verb raising after I⁰ has been introduced and projected as IP does not extend the root node – IP. Thus the operation violates the ER [Extension Requirement = Extension Condition from Chomsky 1995].

Taking Bobaljik & Brown's approach into account, (16) is wrong, since the remerge of V in I should have taken place in (16d) – and thus it violates the Extension Condition. Chomsky (2001) suggests that head movement is not part of narrow syntax (i.e., does not affect LF), which has also been assumed by many linguists since. However, Roberts (2010) defends a syntactic approach to head movement by taking a wide range of data into account. I will follow Roberts here and assume that head movement is a syntactic operation, as in (16c).

An important question concerns the restrictiveness of representation and derivation. In X-bar theory, introduced by Chomsky (1970), all phrases were considered to be endocentric. That is to say, they each were required to have a head. The X-bar schema is also subjected to the further restriction of binary branching. A representation of a phrase typically therefore has two non-minimal levels (X' and XP (=X'')). A specifier (YP) will appear as a sister of X', and a complement (ZP) as a sister of the head. (18) is a formal representation of the structure already given in (16).

(18)

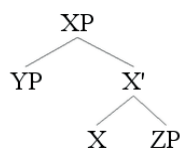

To begin with, the X-bar schema only included the lexical categories V, N, A and P; the S and S' categories were not fully generalised in the scheme until Chomsky (1986).²⁶ The X-bar schema allows only one specifier position in each phrase, meaning that it postulates just one subject position in the sentence (e.g., base-generated VP-internally). The further restrictions

²⁶ Stowell (1981) did suggest an endocentric InflP to replace S, but the complete generalisation of the X-bar schema, including the CP, was suggested by Chomsky (1986).

on movement formulated by Rizzi (1990) restrict a phrase to moving into only an argument (A) or a non-argument (A') position, the latter referring in practice primarily to the topic position in the sentence. The inclusion of the left-periphery in the X-bar-schema ($S'' \rightarrow CP$) leaves us with just one topic position; only Spec,CP can host the A'-moved element.

When taking Norwegian data into account, these two restrictions seem to be fruitful generalisations (cf. Åfarli & Eide 2003: 70ff, 192ff, Nygård 2013). By only allowing a head to project to a second non-minimal level, certain empirical facts are straightforwardly predicted by the model. However, the restrictions imposed by (18) were questioned both conceptually and empirically with the launch of the MP and *Bare Phrase Structure* (BPS) (Chomsky 1995: 241ff). BPS rejects the existence of the bar level (X') and suggests that a lexical element decides whether it projects one or two non-minimal levels. Strictly speaking, these are not new levels, but new copies of the lexical element. A great advantage of BPS from a minimalist perspective is thus that projection and movement can both be reduced to copy theory, so that we only need Merge and Copy to build structure (cf. Boeckx 2006: 176).

Given Chomsky's (1995: 243) definition of Merge, a complex item (with internal structure) can merge with another complex item, and hence nothing prevents us from generating structures with multiple specifiers.²⁷ Then we should in principle expect languages with multiple subjects as well, and Lohndal (2012: 53f) shows that this is also the case. Data from Japanese (Kuno 1973, Koizumi 1995), Modern Standard Arabic, and Modern Hebrew (Doron & Heycock 1999) suggest that multiple subjects are possible. This again suggests that the predictions made by the X-bar schema are too rigid.

On the other hand, if one adopts BPS in the first place, restrictions on generating multiple specifiers must be stipulated in a clear majority of the world's languages (including Norwegian). The theory indeed needs to take the data from Japanese, Modern Standard Arabic and Modern Hebrew into account. However, Lohndal (2012: 55) also questions the automatic equation between multiple subjects and multiple specifiers. If we adopt X-bar theory, it could be possible to stipulate that the second subject position projects from a separate, silent functional head.

BPS goes hand in hand with the MP and the operation Merge, and it follows directly from a minimalist (and lexicalist) way of thinking: A projection that need not be generated is not generated. Merge applies only when necessary, and relates the different syntactic nodes. If X needs a complement, X projects once and creates a phrase. If X needs a specifier too, X

²⁷See Lohndal (2012: 52f) for a nice overview.

projects twice. In this way, vacuous projections are avoided. This is motivated from a theoretical perspective.

A possible advantage with the X-bar schema is that it has the desirable effect of toning down the importance of the lexicon as a structure-building component, since BPS is built on the idea of a lexically driven syntax. In the next sub-section, we discuss syntactic exoskeletal frame models and the lexicon–syntax interface. As mentioned in the introduction of 1.2, it will be clear that I do not follow the Minimalist idea that syntactic structure is built on the inherent properties of the lexical elements. Since I consider BPS to be a theory motivated on a lexio-centric ground, this is also less tenable for my purposes. My main purpose is to explain VPrt data, and therefore these data will already be crucial in the next section.

1.2.2 Syntactic Frame Models

Since the development of the Standard Theory by Chomsky (1965), the common view has been that lexical elements, and in particular verbs, are the basic building blocks of the structure-building component: they carry information about how the syntactic structure will be realised. In GB theory (Chomsky 1981), the thematic roles of the verb, known as Theta roles, are assigned to appropriate arguments. The principle that each argument bears one and only one Theta role, and that conversely each Theta role is assigned to one and only one argument, is known as the *Theta Criterion* (Chomsky 1981: 36). The Norwegian verb *like* ‘like’ contains two obligatory Theta roles that need to be assigned to two separate arguments, not one or three, as shown in (19). *Tenkje* ‘think’ assigns one and only one Theta role to one and only one argument, as in (20). *The Projection Principle* (cf. Chomsky 1981: 29) secures that the arguments project into syntax.

- (19) a. *Johan likar.
‘John likes’
b. Johan likar hundar
‘John likes dogs’
c. *Johan likar Margit hundar.
‘John likes Mary dogs’
like: Theta, Theta (___ = role to external argument, cf. Williams 1981)

- (20) a. Johan tenkjer.
 ‘John thinks’
 b. *Johan tenkjer hundar.
 ‘John thinks dogs’
 c. *Johan tenkjer Margit hundar.
 ‘John thinks Mary dogs’
 tenkje: Theta

This is the standard approach in traditional GB theory; the syntactic structure is dictated by the inherent properties of the verb, formalised through the Theta Criterion and the Projection Principle. In this way, the syntactic structure corresponds to the inherent semantic properties of the lexical elements. Borer (2005: 5) refers to this as an endoskeletal model; the syntactic flesh is built on lexico-semantic bone. In the MP, the “Projection Principle” is preserved through the Inclusiveness Condition (Chomsky 1995: 228), which, as mentioned above, dictates that the syntactic structure only converges at LF and PF if it is built on no more and no less than the features of the lexical elements in the Numeration (cf. Hornstein et al. 2005: 74). Thus standard GB and MP models are endoskeletal, and this is also the system presented in important syntax textbooks, including those focusing on Norwegian (e.g., Haegeman 1994, Adger 2003, Nordgård & Åfarli 1990, and Åfarli & Eide 2003). Boeckx (2010) refers to this view as “lexicocentrism.”

Although many assumptions concerning the lexical entry and its role in syntax have changed significantly with the abandonment of DS and SS, the lexicon has continued to be an important structure-building component. However, Borer (2005) rejects the idea that structure is built on the basis of argument structure information contained in lexical heads. In other words, she rejects the view that the VP is formed on the basis of the argument structure of the lexical verb (cf. Haegeman 1994: 33ff). Sveen (1996: 12) notes a problem with polysemous verbs like *take*, which from a lexicalist point of view will have several different lexical entries. Borer (2005) also makes a similar point based on English. Many frequent verbs (like *take*) have their specific meanings (or interpretations) extended metaphorically (instead of new verbs being created), and to account for this, the lexicalist must assume an increasing number of lexical entries for these verbs.

If we assume that the lexicon dictates syntactic structure, we face a lot of empirical challenges, as noted by Sveen (1996), Borer (2005), Nygård (2004, 2013), Åfarli (2007, 2012), Lohndal (2012, 2014) and others. An argument against lexicocentrism is the fact that

many verbs seem to exhibit extensive argument structure flexibility. To take one example, what are the inherent lexico-semantic properties of *ete* ‘eat’?

- (21)
- a. Johan et.
‘John eats’
 - b. Johan et frukost.
‘John eats breakfast’
 - c. Johan et kjøleskapet tomt.
‘John eats the fridge empty’
 - d. Johan et Margit ut av huset.
‘John eats Mary out of the house’

Ete ‘eat’ is typically claimed to license *either* one *or* two Theta roles, so that the internal argument is facultative (cf. Åfarli & Eide 2003: 47ff). This is problematic in itself. But in (21c, d), we see that it can be used in different resultative constructions as well. Therefore, a lexicocentric model is not restrictive, and it cannot even explain the syntactic behaviour of a common verb like *ete* ‘eat’.

This is related to Borer’s (2005: 8) coercion examples, “where the structures are interpretable despite the fact that canonical lexical properties of some listemes contained in them have not been appropriately ‘checked’.” In a lexicocentric model, one would expect the syntactic structure to be dictated by the argument structure of the verb. But Borer’s examples show the opposite, i.e., that structures may converge although the argument structure of the verb is not realised in syntax:

- (22)
- a. The alien stared at Kim.
 - b. The alien looked at Kim
 - c. The alien stared Kim out of the room.
 - d. The alien looked Kim out of the room.

This suggests that the syntactic structure does not originate from the lexical-semantic properties of the verb. Furthermore, conventional nouns can surface as verbs (Clark & Clark 1979) and yet be fully interpretable. Borer (2005) reproduces examples where *siren* is used as a verb. Two of them follow here:

- (23) a. The police car *sired* the Porsche to stop.
 b. The police car *sired* up to the accident site.

As noted by Grimstad, Lohndal & Åfarli (2014), who discuss similar *siren* examples, the verb is flexible in terms of argument structure, but the core meaning (to produce a siren sound) is maintained, “though the specific meanings are augmented according to the syntactic environment. This strongly suggests that the meaning of *siren* cannot just come from the verb itself, but that it depends on the syntactic construction” (p. 9 in draft). Note that this is exactly the case with the conventional verb *ete* ‘eat’ in (21), too. Rather than dictating the structure, the specific meaning of the verb (or its interpretation) is coloured or enriched *by* the structure. Borer (2005) provides more examples of nouns that become fully interpretable verbs; Åfarli (2007) and Nygård (2013)²⁸ provide several Norwegian examples. Given a traditional approach, in which the lexical verb is the essential structure-building component, we are ill-prepared to provide an economic and theoretically satisfactory explanation of the existence and syntactic realisation of these verbs.

The examples above suggest that grammatical argument structure properties should be removed from the lexicon, since we can have fully interpretable structures in cases where the content of specific lexical items would predict an unacceptable outcome. If we instead assume a neo-constructionist model, where the structures themselves are primary,²⁹ these problems are solved more elegantly. Borer (2005: 15) refers to neo-constructionist models as *exoskeletal*, using a metaphor for describing the structure as the primary syntactic component, which the lexical items (the listemes) can modify:

[T]he syntactic structure gives rise to a template, or a series of templates, which in turn determine the interpretation. For such an approach, a listeme does not determine structure, but rather, functions as a modifier of the structure (Borer 2005: 14).

This is compatible with a model that posits late lexical insertion. I will assume that the syntactic structure is generated independently of and prior to the lexical elements, and that the nodes in the structure contain empty slots into which the lexical items can be inserted (Åfarli 2007, Nygård 2013: 154). Evidence from language mixing (Åfarli, Grimstad & Subbarao

²⁸ From Nygård (2013: 137):

- (i) Du skal vel bare tante deg i dag, du.
 you shall well only aunt you.REFL today, you
 ‘You are probably going to do nothing but be aunty today, aren’t you?’

²⁹ I will return to the generation of the structures further below, i.e., what actually generates them. See also a discussion on this in Grimstad, Lohndal & Åfarli (2014).

2013, Grimstad, Lohndal & Áfarli 2014) shows that there are constraints on the insertion of functional elements, but that there are no strict constraints in the lexical domain of the clause, i.e., on what kind of lexical item can be inserted in which lexical slot in the structure. When there is a slot that admits the open lexical word classes, “anything” can in principle be inserted. Therefore, we can have a noun in a verb slot in (23). In the functional domain, and for the closed word classes (see section 6.6), there are constraints. Therefore, the stable part of a language, and the part that really characterises a language or a dialect, is the inflectional or functional domain. The lexical content words are volatile and flow between language systems.

With the model we pursue here, where the lexical slots are open for “anything,” we should also expect that it is possible for verbs to surface as nouns, and it is. In a dialogue with my 3-year old daughter Ingjerd, she used a conventional verb *balansere* ‘balance’ in a noun position, where the syntactic environment triggered an interpretation ‘something to balance on’:

- (24) **Ingjerd:** Kan du ta ut stolen?
 can you take out the chair?
 ‘Can you give me the chair?’
- Me:** Kva skal du med den?
 what shall you with that
 ‘What do you need it for?’
- Ingjerd:** Eg skal lage ein balansere.
 I shall make a balance_v
 ‘I will make something to balance on’

In order to select a conventional noun, Ingjerd would have had to know relevant compounds or produce a relative complex: something to balance on. But lacking these alternatives, she inserted the verb instead, which nevertheless gave a fully interpretable structure. The verb is interpreted as a noun when its distribution is that of a noun.

Áfarli (2007) suggests that the number of underlying *frames* (= *templates* in Borer 2005) in a language is low, and argues that there are five such frames in Norwegian in the verbal domain. He assumes that the frames are syntactico-semantic in nature, i.e., that they function “as a formal representation of semantic and syntactic elements and relations” (p. 3). Thus, they serve as an underlying structural backbone for the syntactic “surface” representations. In (21a), the underlying structure has generated positions corresponding to an

intransitive structure, whereas in (21b) it has generated a transitive structure. I refer to Åfarli's (2007) article and to discussion by Nygård (2013: 142ff) for an elaboration of the five different frames. In an abstract underlying frame for Norwegian, the functional domain will have to be filled with inflectional material from Norwegian, while for the lexical categories, there are open "slots," where insertion of any lexical element from any language is in principle possible (Grimstad, Lohndal & Åfarli 2014).

Given that there are very few frames available for Norwegian (e.g., just five verbal frames), they should be acquired and recognised quite effortlessly. Nygård (2013: 150ff) suggests that the frames are not stored in the mental lexicon (which could be possible, since they are few), but that they are built by the structure-building operation Merge. Furthermore, she assumes that the frames originate in a purely linguistic, grammar-semantic (G-semantic, i.e., the semantics that is linguistically relevant, cf. Bouchard 1995: 17) sub-lexicon, from which elements are taken to build the G-semantic underlying frame. The encyclopedic lexicon, which is non-linguistic, is inserted later in designated slots and enriches the G-semantic structure with non-linguistic, general-conceptual information.³⁰ In this manner, the "traditional" lexicon is deprived of linguistic content, and reduced to a structure modifier rather than a structure builder.

In chapter 4, we will see that the Norwegian VPrt data lend support to the exoskeletal approach, with syntactico-semantic frames generated independently of the lexical items. In the VPrt constructions in (25a, b), the lexical elements are identical, but the word orders are different. They also differ with regard to what is their most conventional reading (see discussion below the examples). The underlying reason for this semantic difference must be the word order, i.e., the structural foundation (which can lay the foundation for idiom formation in the former example). This should imply what we have said above is correct, namely that the structure itself carries a basic meaning.

- (25) a. Få opp pakken.
get up the packet
'Open the packet'

³⁰ The portion of the semantic content which is not linguistically relevant, but which belongs to the general-conceptual domain, is referred to as the situational semantics (S-semantics) by Bouchard (1995). S-semantics includes pragmatics and general world knowledge. The distinction between G- and S-semantics will be crucial in the VPrt analysis from section 4.3 onwards, and it will be discussed more thoroughly there.

- b. Få pakken opp.
get the packet up
'Bring the packet up'

The most conventional reading of (25a) is a metaphorical, aspectual reading: open the packet. (25b), however, has an immediate directional reading: bring the packet up (to a higher physical level). This contrast is not predicted by endoskeletal models, since the lexical elements are identical. Rather, the different readings of (25a, b) can be explained in the most natural way if we ascribe them to the different structures, which themselves must carry different meanings. Despite the fact that the particle *opp* 'up' has a basic directional reading,³¹ (25a) is not a directional construction. Given the semantics of *opp*, we should expect a directional reading of both (25a, b). Thus, we will assume that the *position* of the particle is crucial; a structure with a left-hand particle triggers a different reading from a structure with a right-hand particle. We must expect that the lexical items in one way or another modify the structure, and that there is sometimes harmony and sometimes a mismatch or friction between these two levels (cf. Áfarli 2007, Nygård 2013). For examples such as (25), I will continue to claim that the structure is the primary carrier of meaning, and that the semantic properties of the lexical items are secondary, and can modify the structure.

However, given the right context, (25a) can also get a directional interpretation, cf. the following imaginary dialogue:

- (26) **A:** Vil du sjå på pakken her nede?
 will you look on the packet here down?
 'Do you want to look at the packet down here?'
- B:** Nei, få opp pakken.
 no, get up the packet
 'No, get the packet up here.'

Here, the question from person A naturally triggers a directional reading of B's LPrt construction. In other words, the specific context contributes to a directional interpretation of the LPrt construction. Factors such as context, knowledge about the particular situation, and even general knowledge about the world will all play a crucial role for the final interpretation

³¹ See section 4.3.4 for a discussion of the semantics of prepositions.

of any construction. Later, we will ascribe this to what Bouchard (1995: 17) calls *situational semantics*, i.e., the portion of the semantics that is not structurally relevant (cf. footnote 24).

In sum, this means that three decisive factors contribute to the final interpretation of the VPrt construction. In chapter 4 (from section 4.3), I will pursue the hypothesis that the semantics of the *structure* (27i) is primary, the lexical semantics (27ii) is secondary, and the non-linguistic factors (27iii) are tertiary, modifying the others (27i, ii):

- (27) The full interpretation of a structure depends on the three following factors in the given ranked order:
- i. The semantics of the structure
 - ii. The semantics of the lexical elements
 - iii. The general non-linguistic situational semantics (e.g., world knowledge)

In chapter 4, we will see that the rigidity of this hypothesis is fruitful for the understanding of the diversity of the Norwegian VPrt data. However, it is also important to notice that exoskeletal or constructionist approaches do meet some problems and challenges, e.g., when it comes to specific lexical selections. Lohndal (2014: 45ff) discusses some issues, and one of his examples taken from Goldberg (2006: 211), concerning the three synonyms for eating, *eat*, *devour*, and *dine*, can be transferred to a similar problem in Norwegian. The verbs *ete* ‘eat’, *sluke* ‘devour’, *fortære* ‘consume’, and *fråsse* ‘gorge’ all have different argument structures and are apparently *not* flexible.

- (28)
- a. *ete* (maten)
‘eat the food’
 - b. *sluke* *(maten)
‘devour the food’
 - c. *fortære* *(maten)
‘consume the food’
 - d. *fråsse* *(i seg) (maten)
gorge in REFL the food
‘gorge oneself on the food’

In (28a), the object is facultative, while in (28b, c), the object is obligatory. In (28d), a direct object is impossible; *fråsse* ‘gorge’ can either be intransitive or take a resultative complement. The fact that these verbs are semantically similar, but syntactically different has been an argument for lexical selection. However, Lohndal (2014: 46f) meets this criticism with the fact that the verbs are really semantically quite different. For example, while *devour* (= *sluke*) is inherently telic (something is devoured), that is not the case with *eat* (= *ete*). I refer to Lohndal for more discussion on this and emphasise that his arguments can also be used on Norwegian data.

1.3 Dialect Syntax and Parameters

As discussed in section 1.1, this thesis is about the syntactic structure and the semantics of VPrt constructions in Norwegian dialects. And in a comparative perspective it is also taking into account the other Scandinavian languages (cf. 1.1.3). Searching for systematic (co-) variation between languages and dialects has been essential in generative grammar since the late 1970s (Rizzi 1978) and especially since the emergence of the Government and Binding (GB) Theory in the early 1980s, when the Principles and Parameters (P&P) approach was introduced (Chomsky 1981). P&P were supposed to solve the acquisition problem, explain (and predict) differences – and similarities – between languages, and thereby also explain the universal properties of language. My thesis is a generative work that studies the variation between closely related languages (and dialects), which is known as micro-comparativism in the linguistic literature (cf. Hellan & Christensen 1986). Because this is a micro-comparative, generative work, I think it is crucial to discuss parameters and especially so-called micro-parameters in detail. That is, this type of focus could suggest an analysis in terms of classic P&P theory, but I will conclude that micro-variation is not parametric in the traditional GB sense. With some exceptions (e.g., Baker 2001, Kayne 2000, 2005, and Holmberg 2010), there is a general agreement today that parameters are not “global” (Barbiers 2013), i.e., do not explain clusters between remotely related languages.

This section is organised as follows. Sub-section 1.3.1 discusses how dialect syntax was approached in the GB years, i.e., given the old understanding of P&P. Newmeyer’s (2005) objections to the GB style P&P are elaborated on in 1.3.2. In 1.3.3, I discuss the standard minimalist parameters (as adopted in Chomsky 1995), and in 1.3.4 I promote a model, which accounts for micro-variation as the variation in phrase structure and the

operations applying to a given structure. In 1.3.5, I highlight some language-external factors that must be taken into account, but which will not be discussed thoroughly in this thesis. 1.3.6 concludes the section and adds some general notes.

1.3.1 Dialect Syntax in the GB Style Principles and Parameters Framework

The P&P theory was launched by Chomsky (1981) as an answer to the acquisition problem. How can children learn a language so fast with so little and unsystematic input? The hypothesised existence of a biologically predisposed language faculty in the mind was already well established by 1981, as was thus the notion of a Universal Grammar (UG). With the advent of P&P theory, UG was assumed to consist of an absolute and invariable part, common to all languages (the principles), and an open part, which would have its values fixed by experience (the parameters). In the first pages of Chomsky (1981), UG's fundamental dilemma is discussed: It must be flexible enough to cover all existing (possible) grammars, but restrictive enough to permit only a reasonably small number of options for the language acquirer, so that it can account for the different grammars being learned based on relatively poor evidence. The early P&P theory rested on the hypothesis of a highly articulated UG, which included modules such as Case theory, Binding theory, Theta theory, Control theory and more. These were the invariable, universal principles. Chomsky (1981: 3f) notes:

What we expect to find, then, is a highly structured theory of UG based on a number of fundamental principles that sharply restrict the class of attainable grammars and narrowly constrain their form, but with parameters that have to be fixed by experience. If these parameters are embedded in a theory of UG that is sufficiently rich in structure, then the languages that are determined by fixing their values one way or another will appear to be quite diverse [...]

The open part of UG, the parameters, which were proposed to get their values fixed by experience, would include the Pro-drop (null subject) parameter (separating languages with and without lexical subject requirements), the Head parameter (separating head-first from head-final languages), and the AGR parameter (separating languages with and without verbal person agreement). Languages would be compared in order to test the explanatory power of the parameters. Therefore, syntactic similarities and differences between languages became essential, in order to map the properties of UG. Comparative syntax was the ideal method to understand the nature and range of the parameters. A parametric difference between two languages should be able to explain several different properties between the two languages.

Other languages which shared the same properties could then be explained from the same parameter as well.

The early GB assumption of a richly structured UG was challenged in several respects with the emergence of micro-comparative syntactic studies. Kayne (2000: 4) suggested that it was methodologically more efficient to compare closely related languages (and dialects) than more distantly related languages, because the differences between the closely related languages would more likely actually be related:

In the early to mid-1980s, it became apparent to me that a direct comparison of French and English raised difficult problems to a greater extent than a direct comparison of French and Italian. In essence, in searching for clusters of properties, one must make decisions about what syntactic differences can plausibly be linked to other syntactic differences. To a certain extent one is guided by one's knowledge of syntax in general and by the theory within the framework of which one is working. Such general considerations do place limits on the set of hypotheses one takes seriously, but typically the set of plausible linkings remains larger than one would like. The size of that set will of course be affected by the number of syntactic differences there are between the two languages in question. The more there are to begin with, the harder it will be, all other things being equal, to figure out the correct linkings.

Dialect syntax and micro-comparative syntax are in many ways two sides of the same coin, meaning that if you study the syntax of a dialect, you are most likely to do so by comparing it to other closely related dialects, or to the relevant standard. Comparativism is implied in any dialect study, whether the approach is situated within the P&P framework or not. The terms micro- and macro-comparative studies are introduced in Hellan & Christensen (1986: 1) to describe the study of typologically and genetically closely vs. distantly related languages. Like Kayne, Hellan & Christensen motivate micro-comparative research methodologically; closely related languages can be compared more efficiently than more distantly related languages (see also Holmberg 2010 for a similar view), and should give more direct access to the properties of UG (cf. Kayne 2005).

Kayne (2000: 5) notes that in an ideal world, one would be able to manipulate a given language by altering one of its overt syntactic properties, and then seeing what other syntactic consequences that led to. However, in the real world, one is forced to work in a much harder and less direct way. One must try to link syntactic features that are believed to cluster together, and deduce a track back to an abstract common property. Alternatively, one can postulate such an abstract property and see if its predictions match the actual data.

The purpose of studying closely related languages or dialects in the P&P framework, would in Kayne's (2000: 6) words be "to provide a broad understanding of parameters at their

finest-grained (micro-parameters) [...]” Then, if one discovers how parameters work on a micro-level, one should gain a broader understanding of the nature of parameters in general; the micro-parameters should serve to elucidate how certain property clusters can be rediscovered on the macro-level. Classic P&P micro-comparativism is thus done from bottom to top, and its ambition can be ultimately macro-comparative.

Although micro-comparativism is motivated methodologically, it has created some theoretical challenges concerning parameters. Originally, it was assumed that there were a relatively low number of parameters to discover, but the number of suggested parameters increased dramatically as micro-comparative work took off. In 1.3.2, we will see some of Frederick Newmeyer’s serious remarks against this development. No one has been able to suggest an exact (and reasonable) number of parameters, which has eventually devalued their explanatory power. And from an evolutionary point of view, it does not appear that we will find correlates in the mind to justify the (inevitably) high number of parameters. The Scandinavian AGR parameter is a typical example of this. The AGR parameter hypothesis was so fruitful that it led to a lot of empirical investigations, which inevitably and paradoxically falsified it, and also called into question the whole idea of macro-parametric syntax.³²

Over the years, the traditional GB style P&P approach has encountered many problems. Some of its empirical shortcomings are discussed by Newmeyer (2005: § 3), while its conceptual and biological flaws are discussed by Boeckx (2010, 2011), among others. Some works have also in more recent years argued for the existence of macro-parameters (e.g., Roberts 2001, Kayne 2000, 2005, Holmberg 2010, Roberts & Holmberg 2010), but a standard assumption in the field can perhaps be summed up as in the following passage by Barbiers (2013: 923):

There are no global parameters (‘macroparameters’). Parameterization involves different feature specifications of functional elements, i.e., all parameterization is microparameterization (...). According to this view, meso- and macrovariation is an accumulation of microparametric differences. The study of dialects gives direct access to these microparametric fundaments of all syntactic variation, as it makes it

³² The AGR parameter was proposed by Christer Platzack and Anders Holmberg as an attempt to explain several different syntactic differences between the Insular (ISc) and Mainland Scandinavian (MSc) languages using one abstract parameter. A crucial difference between these language groups is that the former has rich subject–verb agreement, while the latter does not. A number of syntactic differences are proposed to follow from this property. These ideas have been discussed in several works over a long period of time (see, e.g., Platzack 1987, Platzack & Holmberg 1989, Holmberg & Platzack 1995, and Holmberg 2010), and thus the details of the theoretical explanations have changed over the years. See Newmeyer (2006) and Garbacz (2010, 2011) for strong empirical counterevidence against the AGR parameter, on the macro- and the micro-level, respectively.

possible to establish correlations between certain grammatical properties while keeping (almost) all other grammatical properties constant.

The empirical shortcomings of GB style P&P have suggested that too much information has been ascribed to UG. Throughout the 1990s and the 2000s, the general tendency has been towards assuming a smaller UG. Given that all languages have recursion, the only universal operation needed is Merge (cf. Boeckx 2011: 207ff, Chomsky 2007, McGilvray 2013: 30). With the shrinkage of UG, parameters are now generally considered to be UG-external, i.e., a part of general cognition. Some of those who still defend a theory of “deep” parameters (Luigi Rizzi, Anders Holmberg, Ian Roberts and others) admit that parameters are restricted by performance factors, and hence that they are not parameters in the GB sense. Boeckx (2010: 12ff) argues exactly from this point of view, maintaining that parameters cannot be restricted by linguistic (competence) factors, that we must get rid of the traditional notion of parameter. Newmeyer argues in several works that parametric theories are fundamentally wrong; in Newmeyer (2005), he argues that since it is impossible to reduce the number of parameters to an adequately low number, the term should be replaced by a general *rule* term. We will look at Newmeyer’s perspective in the next section and then at some modern parametric alternatives in 1.3.3.

1.3.2 Newmeyer’s (2005) Objections and Suggestions

As already mentioned, Frederick Newmeyer has criticised parametric syntax in several works in recent years, on both the macro- and micro-parametric levels. Newmeyer (2005: 73ff) advocates for what is in many respects a less constrained view of grammar than is traditionally promoted by generativists. Instead of accounting for language typology through different parameter settings, he aims to capture the possible variation by assuming language-particular rules, which are constrained by unparameterised principles of UG. Because the P&P program cannot account for the actual diversity of all languages in the world, according to Newmeyer, typological variation is accounted for through extralinguistic (performance) factors (p. 73). Typically, a comparative study in the P&P framework selects a couple of languages or groups of languages, and suggests that the outlined differences reveal something about human language in general. The ambitious conclusions are almost without exception based on a very limited amount of data. Newmeyer defends a less constrained grammatical theory for the two following reasons:

The first is that the degree to which a theory can be constrained is itself constrained by empirical reality. And empirical reality, as I see it, dictates that the hopeful view of UG as providing a small number of principles each admitting of a small number of parameter settings is simply not workable. The variation that one finds among grammars is far too complex for such a vision to be realized. The second is that the degree of grammatical variation is in fact highly constrained, but much more by performance factors than by UG (Newmeyer 2005: 75).

The overall goal of a theory of parameters should be to license a formally simpler theory than a rule-based theory is able to. However, Newmeyer claims that this goal is generally not achieved. To the contrary, parameters are in many cases so numerous and specific that they are in reality rules. GB theorists expected the number of macro-parameters to be low, and a lot of variation to follow from each parameter. Thus, the postulation of an increasing number of more fine-grained micro-parameters could be considered a setback for the GB approach (cf. Boeckx 2011).

A relevant question for parametric syntax that has not yet received a proper answer is the following: How many parameters are there? Kayne (2000: 8) postulates that 33 independent binary-branched parameters should be theoretically sufficient, even if we posit a distinct grammar for 5 billion individual speakers (“2 raised to the 33rd power is about 8,5 billion”). But he proposes that the number of parameters is somewhat higher, around 50, which would also increase the number of possible grammars dramatically. The problem is that in most micro-syntactic work, including work by Kayne, a significantly higher number of parameters (more than 50) is usually proposed. And it is not always obvious what actually counts as a parameter. Newmeyer claims that if one takes into account all of Kayne’s (and others’) findings on minimal variation, the total number of parameters would increase so much that it would be hard to justify from an evolutionary point of view. If all documented micro-syntactic variation represents fine-grained parameters of some kind, there must be a vast number of them. And it is not very likely that these parameters can be associated with distinct representations in the brain.

[J]ust to characterize the difference among the Romance dialects [...] with respect to clitic behaviour, null subjects, verb movement, and participle agreement would require several dozens distinct parameters. [...] If the number of parameters needed to handle the different grammars of the world’s languages, dialects, and (possibly) idiolects is in the thousands (or, worse, millions), then ascribing them to an innate UG to my mind loses all semblance of plausibility. True, we are not yet at the point of being able to ‘prove’ that the child is not innately equipped with 7846 (or 78,846,938) parameters, each of whose settings is fixed by some relevant triggering experience. I would put my money, however, on the fact that evolution

has not endowed human beings in such an exuberant fashion (Newmeyer 2005: 83).³³

The classic P&P approach thus puts us in a paradoxical situation: A large number of parameters seems unavoidable but cognitively/evolutionarily impossible. In Newmeyer's opinion, nobody is in a position today to say exactly how many actual parameters there are, and since this number will probably not be smaller than the number of language-specific rules, there is good reason to favour a rule-based theory.

Roberts & Holmberg (2010: § 2.3) reject Newmeyer's rule-based approach, claiming that the rules are not clearly defined, nor restrictive, and that they generally take the cross-linguistic perspective back to a descriptive, pre-P&P level. Thus, they claim that Newmeyer gives up the explanatory ambition. In my view, this evaluation is unreasonably harsh. The rule notion can be appropriate when our aim is to formulate general rules and regulations on the micro-level, and not to strive for macro-parameters. I will return to this in the two following sub-sections.

In the next sub-section, we will discuss the "standard" minimalist parameters briefly (as in Chomsky 1995), which can be said to take an intermediate position between GB style parameters (which are restricted by UG) and Newmeyer's rules (which are restricted by extralinguistic so-called third-factor principles). In Chomsky (1995), parametric variation is found in the lexicon (i.e., second-factor principles).

1.3.3 *Minimalist Parameters*

In this section, we will briefly discuss what can be considered the "standard" minimalist parametric analysis. Already in Borer (1984), it was suggested that the inflectional system is learned "on the basis of input data" (p. 29), i.e., that acquiring a language is to learn the idiosyncratic properties of the inflectional system of the lexicon. Inspired by Borer's proposal, Chomsky (1995) suggested that parametric variation applies at (the formal features of) the lexicon. This has later been named the *Borer–Chomsky conjecture* (BCC) by Mark Baker (cf. Thornton & Crain 2013: 939). BCC moved parametrisation out of UG to the grammatical domain of the lexicon, i.e. from a first to a second-factor principle. A concrete example of how this turn actually works is demonstrated by Thornton & Crain (2013: 940). In Huang (1982), a wh-movement parameter was proposed. This parameter separated languages with

³³ See also Boeckx (2006, 2011) for a similar conclusion.

(overt) wh-movement at S-structure (as in English) from those with (covert) wh-movement at LF (as in Chinese). In the GB style P&P this parameter was restricted by UG, and the difference between two language groups could be accounted for by distinguishing between movements applying to different interface levels. Then Tsai (1994) suggested a distinction, which is more compatible with BCC, namely that the languages differ with respect to a [+wh] (English) vs. [-wh] (Chinese) feature on the head of the wh-phrase (i.e., the lexical item). This would imply that a plus value on the lexicon triggered an overt movement, while a minus value did not. Thus, the movement is feature-driven, and the parametric difference applies to the lexicon.

A number of advantages by assuming “lexical parameters” and the BCC are discussed in Roberts & Holmberg (2010: § 3.2). Also, they do not see a direct linking between the adopting lexical parameters and discarding macro-parameters. Instead, they try to adapt Rizzi’s (1982) classic pro-drop (null subject) parameter in BCC terms that still preserve the macro-perspective. In 1.3.4, we will claim that the BCC is incompatible with an exoskeletal approach, where the lexicon is irrelevant for structure.

A relevant question is whether Newmeyer’s arguments are strong enough to reject the P&P approach completely, or whether parameters should just be approached differently, as in the BCC. In itself, the parameter vs. rule term does not need to be decisive, except that we need to postulate an adequately restrictive theory. From my point of view, the parameter term is less appropriate than the rule term since macro-parameters are dispensed with (cf. Barbiers 2013), but more appropriate than the rule term since we still argue for a restriction on the micro-variation. The choice of term is therefore a matter of our definition of *parameter* (as UG-external) or *rule* (as adequately restrictive).

There are fewer linguists today that argue for the existence of macro-parameters, and I think the new direction in the field generally legitimates an exclusively micro-syntactic focus in our study. In the next section, I will argue for a principled way to analyse micro-syntactic variation.

1.3.4 *Phrase Structural vs. Operational Variation*

In this section, I will argue that structural variation is essentially regulated in the following two domains:

- (29) **Structural variation** is regulated
- a. on the phrase structure level, and
 - b. by different operations applying to the same phrase structure.

First, note that (29) is consistent with an exoskeletal approach to grammar. (29) predicts that the structural variation is captured by the particular frame/template that is generated, and to the operations that apply to that frame. Second, (29) is incompatible with the BCC, since the structural variation is not connected to the lexicon here.

If we assume that the X-bar schema is universal (cf. 1.2.1), (29) can capture the possible structural variation quite straightforwardly. We could postulate that (29a) is relevant for differences on the macro-level, e.g., SVO vs. SOV, where the X-bar schema is mirrored. Then, the relevant differences uncovered through studies of dialect syntax and micro-variation could be the operations applying to the unvarying schema, (29b). We can then assume, for example, that Norwegian particle alternation is the outcome of a particle movement rule, which applies to an underlyingly identical phrase structure for LPrt and RPrt constructions. However, (29) really represents two different principled ways of analysing empirical patterns. SVO and SOV do not need to manifest different phrase structures (29a), but could instead be derived from a common basic structure, e.g., with a verb movement rule in the SVO alternative, cf. (29b). As discussed further in section 4.3, I will assume that (29a) can also be relevant for micro-syntactic variation, i.e., that some syntactic differences can be the outcome of differing phrase structures – and that LPrt and RPrt constructions constitute one such case. It will be important for the generalisation of the Norwegian VPrt typology to determine whether LPrt and RPrt constructions are phrase structurally different (29a), or whether they are produced by, e.g., movement rules (29b).

Consider first a rule-based difference. If we have the general rule that a trace/copy must be c-commanded by its antecedent, we exclude downward movement in the structural hierarchy. C-command is formulated as follows by Chomsky (1995: 35):

- (30) α *c-commands* β if α does not dominate β and every γ that dominates α dominates β .

In section 1.1.3, we saw that Swedish has apparently obligatory LPrt while Danish has apparently obligatory RPrt distribution. Given that this difference is rule-based, we can assume that a certain movement operation applies in one of the languages, but not in the

other. If Prt–DP is the basic order, Danish has obligatory leftward DP movement, (31a); if DP–Prt is the basic order, Swedish has obligatory leftward particle movement, (31b).

(31) (throw) {out} the dog {out}

a. Danish derived from a Prt–DP order

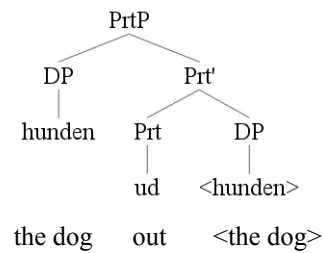

b. Swedish derived from a DP–Prt order

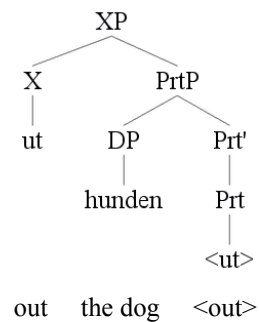

This would suggest that dialect syntax is the study of varying operations over the same phrase structure, cf. (29b). The operational alternatives must be few (e.g., ± a single movement), in order to explain the similarities between the languages/dialects.

However, as stated above, I will argue that micro-variation can also be attributed to phrase structural variation, cf. (29a). Then the minimum degree of variation will be the result of differing phrase structure, not of differing operations. If LPrt and RPrt constructions are phrase structurally different, then there is no direct relation between them. This in turn will devalue the relevance of the alternation problem. (32) illustrates:

(32) a. **Possible Danish representation**

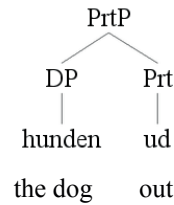

b. **Possible Swedish representation**

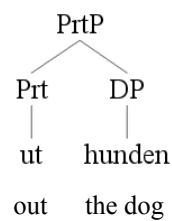

When macro-parameters are dispensed with, micro-variation can be the key to understanding the nature of syntactic variation on a general level, which would be in line with Barbier's (2013: 923) quote in section 1.3.1 above: "all parameterization is microparameterization." Studying the minimal degree of structural variation is a fruitful way of mapping the interaction between (29a) and (29b): Are minimally different structures phrase structurally or operationally different, or both? If our model is successful, so that we can map the micro-variation in the best possible way, we also have a hypothesis for how structural variation in general should be accounted for. (29) does not imply arbitrary variation; many restrictions are already imposed by the X-bar schema, e.g., binarity and hierarchic relations. And if minimally different structures are basically phrase structurally (and not operationally) different, there must be a limited number of frames available (cf. Áfarli 2007).

1.3.5 *Language-External Factors*

Language-external factors affecting variation are not an essential part of this thesis. That does not mean that they are not important. To the contrary, one could well argue that they should rightfully have a more central place in a work studying dialectal variation. Age and social background, among other factors, can explain certain aspects of an individual language variety, but they are not essential to explaining the form of an I-language, or, I think, the structural similarities between dialects. Nevertheless, social background can perhaps

influence the distributional choices being made by an informant from time to time. As we will discuss in chapter 2, a limited number of Ivar Aasen’s informants in the 1840s could probably write (a significantly higher number could read) (see Fet 1995, 2003), so they were neither familiar with nor influenced by the grammar of the written standard, i.e., Danish syntax. We should not underestimate the influence that the written standard can have on more marginal dialect syntax. Some patterns which only belong to spoken variants are only rarely heard in national broadcasting and never appear in the written standards. One such example is (33) from Central Norwegian, which combines LPrt with a light pronoun:

- (33) Han kasta ut’n.
 He threw out him
 ‘He threw him (it) out’

Western (1921: § 454) admits that these constructions appear in the dialects, but underlines that they are hardly (*neppe*) appropriate in educated *Riksmål* speech. Likewise, it is stated in the same paragraph that many East Norwegians will prefer a prominent particle in full DP constructions (*Han kasta UT hunden*), because the dialectal pronunciation with V + Prt (*‘kasta-ut*) spelled out as a prosodic unit (with word accent) can feel vulgar. In my pilot fieldwork (see section 2.1.3), one elderly woman from Fosen was “terrified” by her own grammar in (34a), which deviated significantly from the *Bokmål* standard (34b), which is the written standard in Fosen.

- (34) a. **Fosen dialect:** slii i hel
 beaten.STRONG in death
 ‘beaten to death’
 b. **Bokmål:** slått ihjel
 beaten.WEAK in death
 ‘beaten to death’

The strong participle in the dialect lies much closer to the *Nynorsk* standard (*slege*), but is apparently distant enough from *Bokmål* for the speaker to “scare” herself. Regardless of whether adapting to a standard implies a social gain or loss (if it is considered too posh), the point where the dialect meets the standard is relevant. Furthermore, we cannot pretend that we have true and clean “proto-dialect” speakers today, whose grammatical systems are

unaffected by the standard and other “pure” dialects. I will discuss this problem and dialect terminology in light of the Nordic Dialect Corpus in section 1.4.3.2.

In other Scandinavian languages, the influence of written standards can also be felt. For instance, the syntax of written and perhaps even spoken Faroese is influenced partly by the archaic Old Norse written standard and partly by the Danish standard.³⁴ According to Sandøy (1976), the Faroese particle distribution lies closer to the Danish one than to those observed in Icelandic and Norwegian, and I assume this might have to do with the generally strong Danish influence on Faroese which has persisted for generations.³⁵ One could also assume that the VPrt construction is more sensitive to information structure (cf. Svenonius 1996b, Dehé 2002, Sandøy 1976, 1985) in one language than in another. Furthermore, variation on the micro-level is inevitably associated with language contact. Closely related dialects are often in direct contact, and can mutually influence each other, so their similarities and differences are less likely be studied successfully with a parametric approach (cf. Newmeyer 2006: 5).

1.3.6 Conclusion

We know from Sandøy (1985: 100) that at least in Norwegian dialect studies, *syntactic* variation was more or less an ignored field throughout most of the 20th century (only five pages of his 300-page book on Norwegian dialectology deal with syntactic issues).³⁶ The AGR parameter from the late 1980s was arguably one of the kick-starters in the field (cf. Christensen 1996: 18), and a reminder that the P&P framework seemed suitable for describing Scandinavian micro-comparativism. And the framework has been fruitful despite the general

³⁴ The Faroe Islands were under Danish control beginning in the late 14th century and were an official Danish county from the early 19th century. In 1948, the Faroes achieved a higher degree of autonomy as a self-governing part of the Kingdom of Denmark. Although this means that they are in control of all domestic issues, they are still not politically independent and have two representatives in the Danish parliament. In their 7-year elementary school (from ages 7 to 14 years), everything is taught in Faroese, while Danish is taught as a second language at all levels (see Store norske leksikon, <<https://snl.no/Færøyene>>, accessed September 2014). The Faroese written standard has had different influences. V.U. Hammershaimb’s (1819–1909) standard used an archaic orthography that was strongly influenced by Old Norse. Sandøy (1974: 17) also shows examples where the Old Norse genitive is preserved in the written language, despite its absence in spoken language. However, Skomedal (1981: 92) shows passages from the literature where the Icelandic declinations seem to “camouflage” a Danish-influenced syntax. In both cases, it is quite clear that written Faroese is grammatically different from the spoken varieties.

³⁵ According to Sandøy (1974: 10), children were taught in Danish until 1938. In 1974 only 1/8 of the school books were in Faroese, with the rest in Danish. Danish was also the only accepted church language until 1939 (Sandøy 1974: 12).

³⁶ There are some exceptions, like Heggstad (1916, 1920), but these articles did not trigger much other work in the area at the time.

abandonment of macro-parameters, which is based on a lot of documentation that would not necessarily have been done so systematically without a concrete hypothesis behind it. Therefore, it is reasonable to judge the hypothesis of UG-based macro-parameters in the GB era as successful.

My aim in this section has been to shed light on different approaches to analyse micro-syntactic variation, and I have promoted a model, which claims that

- (35) **Structural variation** is regulated
- a. on the phrase structure level, and
 - b. by different operations applying to the same phrase structure.

In chapter 4, I will use this model to explore whether the particle alternation should be analysed as an outcome of a derivational model, a representational model, or both.

I will end this section with a general note on micro-comparativism. I am convinced that to study dialects in a comparative perspective is not only theoretically preferable, but practically inevitable. In the Scandinavian dialect continuum, it has been claimed that there is no linguistically principled difference between what counts as a language and what counts as a dialect (cf. Johannessen et al. 2009). However, there is one major difference on the external level. The written standard(s) equal(s) the *language*, as most non-linguists understand it. The notion of language implies that a language is an ‘autonomous’ object that does not automatically imply comparison with another object. But dialects are different. Sandøy (1985: 16) defines a dialect as a language system contrasting with another language system,³⁷ and hence it is defined by being compared. It can also be compared to a regional spoken standard or to the national written (or spoken) standard. Given Sandøy’s definition, a “non-comparative dialect study” is a contradiction in terms. Whether there are macro-parameters (Roberts & Holmberg 2010), only micro-parameters (Barbiers 2013), lexical parameters (BCC), or no parameters at all (Newmeyer 2005) is irrelevant in this respect.

1.4 Methods and Tools

There are a number of suitable methods for collecting data in a dialect study, and one method alone probably cannot outperform all others. Rather, different methods have their respective

³⁷ “[V]i [vil] med ein dialekt sikte til eitt språkssystem i motsetning til eit anna, ...” ‘With a dialect, we mean one language system in contrast to another, ...’

advantages and disadvantages, so they can be used to complement one another (cf. Schütze 2010). Hence, we should get more reliable answers by combining methods. Schütze (2010) mentions three typical kinds of data that are used in linguistic work: corpus data, judgement data, and experimental data. In my work, I have tried to take advantage of the relatively newly established *Nordic Dialect Corpus* (Johannessen et al. 2009, henceforth NDC), which was officially launched in November 2011 at the University of Tromsø, and my main focus will be on that. However, I will divide the bulk of the data into two groups: introspective(-like) data and “authentic” data. I will begin by discussing the introspective data in sections 1.4.1–1.4.2. Then, the authentic data will be discussed in 1.4.3–1.4.4. In 1.4.1, I discuss situations where introspection is fruitful and even necessary. I consider fieldwork with acceptability judgement tests (1.4.2) as a kind of introspection too, namely into the minds of the informants. Although they are not 100 % identical, I see judgement data and introspection as principally related activities, and thus these are treated successively.³⁸ In 1.4.3, I discuss corpus data. A lot of my data are taken from the NDC; I will present and evaluate corpora in general in 1.4.3.1 and the NDC in particular in 1.4.3.2 (the specific searches and results are discussed in section 2.1.3). The corpus reveals which constructions are more common than others, and therefore also indicates which are preferred. This will be highly relevant to the alternation problem. In addition to more traditional methods, I will take advantage of the dialect material in the *Norsk Ordbok* ‘The Norwegian Dictionary of spoken language and the *Nynorsk* written language’ at the University of Oslo. This will be discussed in 1.4.4. In 1.4.5, I end the section by mentioning some of the dialectologically oriented work that I will use.

1.4.1 Introspective Examples

The first source that I will comment upon, and which will become important in chapter 4, is introspection. Since the very start of generative grammar (Chomsky 1957, 1965), introspection has been an important method for examining the possible structures in one’s own mother language. This method can be considered a consequence of I-language being the object of study, and must be seen in connection with the basic notion of a generative grammar: “[T]he grammar of a language is represented by a formal set of rules that ‘generate’ (i.e., specify explicitly) the possible sentences and their associated structural properties”

³⁸ The fieldwork done in this particular project was organised by the Nordic Center of Excellence in Microcomparative Syntax (NORMS) and was carried out during the initial stages of the work, so that it had the effect of a pilot study (see 2.1.3).

(Newmeyer 1986: 67). Thus, through introspection one should be able to classify (im)possible structures, which we do not encounter in spontaneous speech. However, the method has faced massive criticism over the years (see e.g. Schütze 1996: 48ff).

In the particle literature, one could rightfully criticise the use of introspective data in, e.g., den Dikken (1995: 66). His Norwegian data are constructed and judged by one single Norwegian informant, who also happens to be a linguist. While the data corroborate den Dikken's analysis developed for English quite elegantly (the sources of the English data are not specified either), two problems immediately arise: Firstly, the particular choice of data could be influenced by den Dikken's hypotheses, since the data are presumably constructed on the basis of his ideas (cf. Newmeyer 1983). Secondly, and independently of whether they are influenced by the researcher or not, they are judged by only one informant (who is also a linguist). So, if this is a proper investigation of I-language, it is still only one person's I-language, and should therefore not be claimed to be representative for "Norwegian".

Even though introspection has faced a lot of criticism, especially when it is not supported by other methods, it has a natural position within generative grammar, even outside of the historical context. When we try to ascertain what is a possible structure in a given language, we form hypotheses and manipulate sentences. We discuss the data with colleagues in different settings, and they might come up with fruitful additional introspection. Thus, introspection does not equal or replace an empirical investigation, but it is a natural working method when making hypotheses about, thinking about, and discussing linguistic issues. It is important to stress that discussions with colleagues may amount to a kind of introspection, so the term does not literally mean an examination of one's own mind. I consider introspection a necessary part of a linguistic work, which not only has a natural and rightful place in linguistics, but an inevitable place. However, its major advantage is in many ways its major drawback: The fact that you do not have to move from the office chair to get "data" can lead to a certain exaggeration and misuse of these "data." Even if one investigates one's own mother language, that is really only an investigation of one I-language (and perhaps those of colleagues representing one I-language each). I will therefore not use the term *data* for sentences that I construct or manipulate myself. Let us just refer to them as (possible or impossible) *examples*.

Introspection is clearly reminiscent of, but not quite the same as, acceptability judgement tests as done with informants during fieldwork. The goal of both is to access the I-language of a speaker, as opposed to a corpus study, where one studies actual language production (E-language). However, Schütze (1996: 50) separates the linguistic intuitions of an

informant from introspection, as the term is understood in traditional psychological experiments:

[I]f subjects are reporting on truly mental states (to which only they have access), then their reports are *in principle* uncheckable; therefore, if intuitions are to be any good as data, they must differ in some way from this sort of introspections. Fortunately, I believe they do. Linguists are not asking subjects to describe an internal mental process when they encounter a sentence – not even thinking aloud is involved, only reporting a reaction (Cohen 1981). Introspection is reflection, analysis, or careful thought applied to accessible contents of the mind, which do not include grammatical knowledge. Thus, linguists are not introspectionists.

However, introspection as described in this section lies closer to the “psychological” understanding of the term, since it refers to the linguist’s own reflections on the language, and not only the intuitions of the informant. Exactly for this reason, and based on Schütze’s observation, I think we should be careful not to refer to a linguist’s own examples as “data.” Instead, we should stick to the term *examples* since they first and foremost illustrate our thinking.

VPr constructions are frequent in Norwegian, and a corpus like the NDC (see section 1.4.3.2) can easily reveal the actual distribution of the particle, to the left or the right, but it does not directly reveal the semantic difference between the two, which we must extract from each example. From section 4.3 onwards, when the alternation problem is clarified and an analysis in line with traditional generative approaches is suggested, I will discuss the theoretical outcome on a more principled level. This is a very important part of the thesis, and in these discussions, introspection is an inevitable and useful method. When we move the discussion into a more detailed semantic realm, a corpus alone cannot come to the core of these problems, because it cannot provide varied enough data to support or contradict the theoretical hypotheses. One can “stretch” the authentic data by using them as inspiration for various manipulations of the sentences they provide (to be examined through introspection), but the authentic data alone simply do not supply enough material. They are not sophisticated, articulated, or numerous enough.

I will typically illustrate and manipulate “minimal meaning pairs,” which despite their small differences are intuitively quite different. In such cases, the use of introspective examples is efficient and appropriate, i.e., when the difference in acceptability between two similar sentences is striking, and to a less extent a result of individual or dialectal variation. I will manipulate both constructed and authentic examples, so that the introspective examples are all in all quite diverse. Consider the following pair that will be discussed further in section 4.3:

(36) a. **RPrt:** Køyre bilen inn
drive the car in
'Drive the car inside' (e.g., the garage)

b. **LPrt:** Køyre inn bilen
drive in the car
'Drive the car inside', *or*
'Break in the car'

(37) a. **RPrt:** –Gå skoa inn
walk the shoes in
'Walk the shoes inside'

b. **LPrt:** +Gå inn skoa
walk in the shoes
'Break in the shoes'

It is not very likely that any Norwegian corpus will have all these concrete examples confirmed (at least not (37a), which I will argue in 4.3 is more marginal). Neither of the examples is found in the NDC. The closest we find is *kjøre inn høyet* 'drive in the hay,' which is confirmed with a couple of LPrt examples, but not with RPrt. In *Nynorsk* *korpuset* 'The *Nynorsk* Corpus',³⁹ (36a) is found four times, but none of the others are present. Still, these examples (at least three of them) are highly conventional, and all of the words are common (all of the different examples and interpretations are also confirmed with Google search results).⁴⁰ I will show in section 4.3 that constructing and discussing minimal pairs of this kind is very efficient and fruitful. If we were confirmed to discussing solely authentic

³⁹ *Nynorsk* *korpuset* is a large text corpus consisting of more than 100 million words from a wide range of *Nynorsk* sources, e.g. novels, children's books, newspapers, textbooks. The corpus is available online at < <http://no2014.uio.no/korpuset/>> (accessed October 2014).

⁴⁰ Yet, to rely on Google searches is not unproblematic. Schütze (2010) discusses several problems by using the World Wide Web as a corpus. Qualitative problems include lack of background knowledge for many of the hits. On many web pages we do not know who actually created the content on them (and therefore we do not know their first language or dialect either). Furthermore, we cannot control whether some hits are machine-translated or not. Quantitative problems include the commercial search engines, which use proprietary algorithms so that we do not know how they arrive at the number of hits we get (the web is too big for any search engine to count *all* results exhaustively). In addition to this, when there are, say, a million hits, we do not know how many of these are actually multiple copies of the same content.

examples taken from a Norwegian corpus, we would not make much progress in our theoretical discussions. Introspection is not a replacement for empirical work, and introspective examples are not true data. Nevertheless, in order to make fruitful hypotheses in theoretical work, they must be included at some level, since they are a crucial part of the thinking of language.

1.4.2 *Fieldwork and Acceptability Judgement Tests*

Here, I will discuss some general issues concerning linguistic fieldwork, how it is complementary to other sources of data, and what limitations it has. In section 2.1.3, I will relate this to a concrete pilot fieldwork done initial stage of the project. Judgement tests also imply introspection, i.e., the informants' examination of their own grammar. Yet, it can be argued that their spontaneous reaction on a sentence does not involve a conscious investigation. Schütze (1996: 24) believes that basic judgement relates to performance, while their intuition relates to competence. I will return to the notions of *performance* and *competence* below.

A problem with investigating syntactic properties that deviate from the standard is that they are relatively infrequent. Therefore, recording and analysing free speech material in search of these specific constructions is quite inefficient. Standard VPrt constructions are not infrequent, but more specific types such as colour adjectival LPrt constructions are more rare. To gain more direct access to marginal constructions, a kind of elicitation is often preferred. Informants can be asked to judge different constructions, e.g., on a 5-point scale, and evaluate "how possible" the constructions are. The impossible constructions have always been of interest for generative grammarians, in the sense that speakers have immediate knowledge of impossible structures in their language despite the lack of negative evidence. That is, when a speaker judges a sentence as unacceptable, the linguist might conclude that the sentence is impossible/ungrammatical. Ungrammatical sentences should thus tell us something about the nature of the faculty of language. It is important to be aware of the general distinction done between the *acceptability* and *grammaticality* of a sentence. Chomsky (1965: 4) distinguishes between the *competence* and *performance* of the speaker/hearer. The competence relates to the speaker's/hearer's knowledge of his language, while the performance is the actual use of the language. When the speaker/hearer spontaneously judges a sentence, it is a matter of acceptability judgement of performance. It is the task of the linguist to analyse the

(un)grammaticality of a sentence further, and thus to map the competence of the speaker/hearer. A more thorough discussion on this is found, e.g., in Schütze (1996: 19ff).

Since a spoken corpus is a collection of spontaneous speech, it does not provide negative data. Acceptability judgment tests are an efficient method for compensating for this (Cornips & Poletto 2005, Schütze 2010). This means also that they are more suitable for investigating marginal constructions than a corpus (a given construction may not appear in the corpus, but still be possible). A corpus needs to be parsed in order to get direct access to the phenomena of interest. In judgement tests, we can ask directly about specific construction types.

Judgement tests can be done with a written elicitation scheme or orally. The former method can in an unfortunate manner trigger the informant to access his explicit knowledge about (written) language (Aksnes 2003: 25f, Cornips & Poletto 2005: 943, 950, Sandøy 1994: 205), or provide prescriptive viewpoints. It is my impression that this is generally the rule when a linguist asks a non-linguist about linguistic issues (e.g., on Facebook or in other debate forums). Prescriptive rules are however usually not of interest for the linguist. Cornips & Poletto (2005: 952) suggest avoiding this problem by using certain question techniques, e.g., asking whether the informant has heard a given sentence in his dialect, which variant is the most common, etc., rather than asking which is the best alternative. Lack of context may also be a problem for written elicitation schemes. A sentence can be judged as ungrammatical until a suitable context comes up in the speaker's mind (Sandøy 1994), so the sentence is actually better than it looks without context. But a marginal sentence can also work unreasonably well if it is repeated many times and thus "normalised." This is known as the satiation effect (Snyder 2000). Therefore, it is not necessarily an advantage to let the informants read the examples. The greatest advantage of written elicitation is that many informants can be queried simultaneously, so more data can be collected than in an oral interview.

The informants may evaluate the given sentences with numbers on a scale, e.g. from 1 (very bad) to 4 or 5 (OK) (alternatively: *, ?, ??, OK). The 5-point scale is well established in the Scandinavian dialect fieldwork, see e.g. *The Nordic Syntax Database* (Lindstad et al. 2009), where this system is carried through. A problem with the 5-point scale is that it sometimes seems easy to go for the "undecided" middle point (3 points) when one is insecure of the actual acceptability. This can be avoided by using even-numbered scale (e.g., 4-point scale), so that the informant must pick at least a "good" or a "bad" alternative.

For the purpose of this thesis, it is also important to know that most Norwegians write a language that is, among other things, syntactically closer to Danish than the language/dialect they speak. This could suggest that many speakers may be capable of judging a sentence (at least in a written elicitation scheme) in a more Danish direction than what is actually representative of their dialect.⁴¹ The LPrt preference hypothesis, if correct, means that spoken Norwegian is more “Swedish” on the syntactic level than is indicated by the Danish-influenced written standard(s). Especially since *Bokmål* is the first official language for a great majority of the speakers, there will necessarily be a significant syntactic discrepancy between the oral production and the judgement of a “correct” Norwegian sentence.

Oral elicitation enables the linguist to explain the sentences in meta-terms, and to interpret and follow up on the answers more easily (cf. Cornips & Poletto 2005: 949). It also gives the linguist the opportunity to prevent the informants from mixing up the content of the sentence with its form, so that they do not base their grammatical judgement on the truth value of the sentence (Schütze 2010).

In sum, the situation can dictate which method is more appropriate. If a group of linguists share a certain pool of informants for a period of time, and each linguist has access to one or two informants at a time, an oral elicitation is preferable, since the advantages of the written elicitation cannot be exploited. The nature of the phenomenon under investigation will also influence the choice of method. For example, a difficulty with investigating VPrt constructions is that, although I hypothesise that most Norwegians prefer the LPrt alternative, most speakers will also accept (and even prefer) the RPrt order in some contexts. If the informant judges written sentences, RPrt constructions will probably have a higher degree of acceptability than if they are presented orally. In some cases, grammaticality vs. ungrammaticality will be relevant; in other cases preferences and degrees of acceptability are relevant. This is why an oral elicitation may be more helpful in the VPrt case. However, it also makes any authentic speech material (e.g., the NDC) even more invaluable, because actual usage will also give us an idea of the real preference.⁴²

⁴¹ In section 4.6, I will suggest that the particle alternation in Norwegian is actually a result of parallel grammars, i.e., that the use of a right-hand particle is the result of using a Danish grammar, which basically all speakers of Norwegian are capable of. The right-hand particle is then associated with the general Danish influence of Norwegian over the centuries. The diachronic Danish position in written Norwegian suggests that learning to write any of the Norwegian standards is adapting a Danish-coloured grammar.

⁴² Endresen (1988) examines the distribution of negation and light pronouns in Central Norwegian and North Swedish, and he concludes (on his p. 54) that in order to discover the real syntactic patterns, and the actual competence of the speakers, he would need an authentic material of spontaneous speech. He notes a clear discrepancy between what the informants believe they say, and what they actually say (p. 53).

Especially in the last 15 years or so, there have been a lot of papers criticizing and questioning the reliability of acceptability judgement tests,⁴³ one question being whether generative grammar should adopt experimental methods from psychology, since it defines itself as a sub-branch of psychology. Some have claimed that traditional acceptability judgement tests are unreliable in that they have a high false positive rate, and also a high false negative rate (Sprouse & Almeida 2012: 611f). Sprouse & Almeida (2012) go through 469 examples in Adger (2003), and test them with traditional syntactic methods compared to experimental psychological methods. They conclude that there is a discrepancy of 2 % between the two methods, and that these are false positive errors. A similar investigation of data from *Linguistic Inquiry* 2001–2010 (Sprouse, Schütze & Almeida 2013) shows a discrepancy of 5 %. They thus defend acceptability judgement methods and deem them suitable for linguistic investigations.

1.4.3 Corpus Data

1.4.3.1 Corpus Studies in General

A text corpus is usually defined as a collection of language data (Schütze 2010), or of written or spoken texts (*Oxford Advanced Learner's Dictionary*). The fact that a corpus consists of *collected* text material (for a linguistic purpose) is important. An obvious advantage of using text corpora is that they contain a large amount of data. *Nynorskorpuset* 'The *Nynorsk* Corpus' contained more than 100 million words by the end of 2013. A written corpus usually represents different genres, e.g., novels, newspapers, political reports, and textbooks, so that a broad range of social and stylistic use of the language is covered. Corpora of spoken language vary widely in size and content. The Text Laboratory at the University of Oslo provides several written and speech corpora; The *Big Brother Corpus* is an example of the latter and contains 550 000 words. *No Ta-Oslo* (Norwegian Speech Corpus – the Oslo part) contains 900 000 words. The NDC, which will be discussed in the next sub-section, is from this perspective a rather large speech corpus, with 2,8 million words.

It takes a great deal of work to record, transcribe and tag conversations so that they are usable for researchers. Written corpora are finished texts that basically just need to be tagged, and thus they are usually much larger than the speech corpora. However, even “small” speech

⁴³ A comprehensive list of references is given by Sprouse & Almeida (2012: 610).

corpora provide amounts of data that are impossible to collect through individual fieldwork. Therefore, a well-developed corpus is an invaluable tool for a PhD project like this, whether it contains half a million or a hundred million words.

There are also other advantages of corpora, in addition to the large amounts of data that they usually contain. Corpus examples occur in a given context, unlike the examples in acceptability judgement tests (see 1.4.2). This is a huge advantage, as mentioned by Schütze (2010). An example that in isolation can seem ill-formed can prove to sound natural in the right context. And as long as the recording situation is appropriate, we must count corpus examples as authentic. Another advantage is the fact that a corpus is built for the purpose of linguistic science – but not for one particular project. Therefore, the data are not so coloured by our own hypotheses (Johannessen 2003), since they are produced independently, not elicited by the linguist for a particular narrow purpose. Many corpora are parsed, allowing us to search for phrases and word strings. This is crucial for syntacticians.

Corpus studies also have some drawbacks, which suggest that we should supplement them with other methods as well. Johannessen (2003) mentions the problem of marginal constructions. There are many marginal constructions that are possible to produce, but which are not very frequent. If we want to find very marginal constructions, we need a really large corpus, and a large corpus is expensive to develop. For example, Åfarli (1985) claims that colour adjectives can be distributed as LPrt in the Halså dialect (in Nordmøre) (*måle gul bilen* ‘paint yellow the car’). However, the NDC does not show any such examples from Nordmøre or the rest of the country. Schütze (2010) discusses what this kind of absence could mean. Is it because of the nature of the particular corpus (size, the themes being discussed, etc.) or simply that the construction is impossible to produce (for most)? A corpus leaves the question open.

A corpus also represents a “locked” source in many respects. Some corpora expand continuously over many years, but usually a certain amount of money is used to develop the corpus within a given time frame. Hence, a corpus is finite, both in terms of the time span (on the order of a few years) from which the texts or the recordings are taken, and simply in terms of the actual amount of data included (Johannessen 2003). We will discuss the limitations of the NDC in this regard in the next sub-section.

1.4.3.2 The Nordic Dialect Corpus: Dialects, Transcription, and Informants

The Nordic Dialect Corpus (NDC) (Johannessen et al. 2009) is a speech corpus that has been

developed by researchers within the ScanDiaSyn and NORMS networks, and was officially launched in Tromsø in November 2011. The NDC consists of more than 2,8 million words from conversations and interviews of 821 speakers from 228 measure points across the North-Germanic dialect continuum (Johannessen & Hagen 2014: 15). Almost 440 of the speakers and 111 of the measure points are Norwegian (op.cit.: 17). This means that we have quite a lot of authentic free speech (though in “controlled recording situations”, cf. Johannessen 2009a) which is well designed for micro-comparative studies and thus invaluable for this project. The NDC covers five countries – Iceland, the Faroe Islands, Norway, Sweden, and Denmark (plus the Swedish-speaking part of Finland) – and it is transcribed by the respective national standards, i.e., *Bokmål* for the Norwegian portion. According to Johannessen et al. (2009: 74), *Bokmål* was chosen for practical reasons “since there exist important computational tools for this variant.” However, one could well argue that *Nynorsk* would be more appropriate for linguistic reasons, since it is closer morphologically – and syntactically – to most of the dialects involved. For example, the dialectal wh-question in (38a) can perfectly be transcribed to *Nynorsk* (38b), but has no equivalent in *Bokmål* (38c).

- (38) a. **West and North Norwegian:** Ka/ke tid kom han?
 b. *Nynorsk:* Kva tid kom han?
 c. *Bokmål:* *Hva tid kom han?
 what time came he?
 ‘At what time did he arrive?’

For finite VPrt constructions, the choice of transcription language is not decisive, but in participle constructions, *Nynorsk* generally allows both agreement and non-agreement of strong participles, and thus covers the dialectal variation more satisfactorily. The infrastructural argument for choosing *Bokmål* as transcription language is understandable, but it is less compatible with the fact that 1) the corpus covers a lot of (mainly) rural dialects, and that 2) it also features a number of relatively conservative speakers. However, recently the NDC has been extended to include dialect transcription, so there is a direct written comparison between the dialect and the *Bokmål* standard. This is a significant improvement, which gives an immediate and striking visual representation of the differences between the spoken varieties and the *Bokmål* standard. It also makes the corpus much more interesting and user-friendly for non-linguists, especially since the dialect transcription is done in Latin letters. A brief example from Ål in Hallingdal follows:

- (39) **Bokmål transcription:** og så har jeg vokst opp i fjellbygda Vass
Dialect transcription: å så ha e vekke opp i fjellbyggde Vass
and then have I grown up in the mountain village Vass
'And then I have grown up in the mountain village of Vass'

Three differences are especially conspicuous: the personal pronoun (*jeg – e* 'I'), the weak vs. strong participle (*vokst – vekke* 'grown') and the particle (*opp – opp* 'up'). This transcription can in fact provide direct comparisons of any dialect with both of the written Norwegian standards, which makes it an invaluable tool for teachers of Norwegian in school, not only for researchers. I think this improvement is crucial.

I will now discuss the informants briefly, and focusing mainly on the Norwegian part of the corpus. Typically, two older and two younger speakers of each gender are represented from each town/village or measure point, and they have to fulfil some criteria to be qualified as informants, e.g., have little or no education, and have grown up and lived most of their life at the relevant measure point. In isolation, these criteria are highly reminiscent of Chamber & Trudgill's (1980) NORM ('non-mobile older rural males') classification. But to the credit of the corpus, both men and women are included systematically, and there is balance between the generations.

Some of the inclusion criteria are outlined by Johannessen (2009b: 9), though the informant criteria are simplified to a quite problematic level, e.g., "each informant must speak the local dialect." This is probably meant to stress the criterion of "local connection," but from a linguistic point of view, "the local dialect" should be defined by the actual recordings rather than by the expectations of a linguist. I think it would be more correct to claim that "local dialect speaker" in this corpus essentially means a "traditionalist" rather than an "average speaker" from a given community, and that the chosen informants are supposed to carry as little influence from the surrounding dialects as possible. A dialect can be defined as a geographically bound language system (cf. the general discussion by Sandøy 1985: 16), but the NDC clearly uses social criteria for the informants as well (little or no education, little or no migration). The corpus does not show any pattern of modern migration, so we must account for a significant group of speakers from each measure point who do not necessarily sound like the informants "representing" them in the corpus. In that sense, although the recordings are nearly as up-to-date as possible, the corpus still represents the traditional dialects, even among the young speakers. But it does not reveal how representative the young

traditionalists are in village A vs. B or C. Nor does it show other, more recent influences on a given dialect, which are relevant at least for some studies. However, as a tool for measuring the most extreme syntactic variation, the NDC is appropriate, as long as we keep in mind that the informants are not randomly picked “average speakers” from the given measure points. There is probably more variation within a measure point than the corpus reveals, and – on average – less variation between many of the measure points than indicated by the corpus.

An argument in favour of using a homogenous group of informants is that there are only four of them from each measure point (in the Norwegian part of the corpus). With four arbitrarily picked informants, it would not be possible to generate useful dialect maps from the corpus, and we would get a misleading picture of isoglosses. With relatively conservative speakers, we are able to spot the differences more clearly and thus to discover “all” dialect syntactic variation that the given area offers, i.e., the most extreme variation between the dialects and the syntax that deviates the most from the written standards. It could then be hypothesised that the syntax of the less traditional speakers (of each generation) lies closer to the written standard.

One could probably also claim that a sample of only four informants is quite a low number for the characterisation of a dialect. I think that using a homogenous group compensates for this, in the sense that it can more reliably describe the more stable part of the dialect, which can serve as a starting point for further investigations. It also makes the comparative work more reliable, since the criteria for all informants for each of the 111 Norwegian measure points are basically the same. An unstable group of informants that varied arbitrarily from place to place would not be suitable material for comparison. One should keep in mind that the NDC is a pioneering work, and that this project has collected more data and systematically compared many more dialect speakers than has ever been done before in the Nordic countries. It would not be feasible to record a much larger number of informants due to the geographically wide range of the corpus. Fieldwork is expensive to carry out, and all the supplementary work necessary to prepare the corpus is even more so. Twenty-minute-long conversations with four informants times one hundred measure points equals a lot of transcription work and tagging.

Like all other corpora, the NDC was created within a limited amount of time, and the recording period for the Norwegian portion was from around 2005 to 2011. This means that the recordings represent a certain group of speakers during these years, which is an important limitation of which we must be aware.

In sum, there are practical and necessary reasons to limit the number of informants included in the corpus, and also advantages to using a homogenous group across the country. However, the informant criteria are still not 100 % clear to outside researchers. I have not seen the criteria formulated precisely anywhere. We get a rough idea of the criteria from Johannessen (2009b) (i.e., traditionalists as preferred informants), but not why these particular informants are selected (rather than others). The reasons and consequences mentioned above for using traditionalists are my own judgements and speculations. One can get the impression that the notions of “dialect” and “dialect speaker” are somewhat oversimplified and idealised in the NDC. However, I think it suffices to be aware of the problem, and also recognise some of the advantages of the homogenous informant groups that the corpus offers. This means that there is variation within the villages that I do not pay much attention here, and hence that the definition of a dialect in this thesis is idealised. In reality, a dialect will not appear as pure as I define it here, and also the pure dialect speaker, with an intact and pure local language system, does not exist. To the contrary, we must assume at least the younger all speakers are multilingual to some extent, in the sense that they mix grammatical systems (see section 4.6). However, the many of the old speakers in the corpus do not speak foreign languages, but can be counted as multilingual since they understand multiple dialects (cf. Vulchanova et al. 2012).

We are not studying idiolects; the term “dialect” presupposes some kind of generalisation, namely the system behind an unconscious norm or “agreement” within a society of speakers, which provides a common denominator for the individual language systems (cf. Sandøy 1985: 16). Hence, the following definition of a dialect is an idealised construct, but hopefully usable for the purposes of this work.

- (40) **A dialect** is a geographically based language system different from other geographically based language systems, and different from the relevant written (and spoken) standard(s).

This is definitely an idealisation and construct of the dialect term, where several nuances are ignored,⁴⁴ but I think the limitation is appropriate for our purposes. Defining a dialect as a language system is to approach the term on a syntactic level. By doing so, we also assume the structure to be the primary ingredient of the language. Some important consequences of (40)

⁴⁴ Cf. also Barbiers (2013: 900) discussion on idealised idiolects.

are already mentioned in section 1.3.6. A dialect is automatically an object of comparison, and when geographically defined, it is also never found in its entirety in one single speaker. A dialect is not found at the individual level, and each individual has more language systems intact than of one pure language system. Studying language systems also means that we are not primarily occupied with the actual production of the speakers, but with how and why the production comes out the way it does.

In section 2.1.2, we will return to the NDC and discuss the search interface and the specific searches conducted for the purposes of this work. The search results will be presented throughout chapter 2.

1.4.4 *Norsk Ordbok*

Prior to beginning the present project, I worked four years as a full-time editor for the *Norsk Ordbok. Ordbok over det norske folkemålet og det nynorske skriftmålet* ('The Norwegian Dictionary of Spoken Language and the *Nynorsk* Written Language,' henceforth NO), and I have continued as a part-time editor for the NO during the preparation of this thesis. In 2015, the NO will be published as twelve 800-page volumes comprising the complete dictionary, including material from the *Nynorsk* written language from the last 150 years, and also data from spoken Norwegian from the last 400 years (i.e., spoken Modern Norwegian). The NO project started in 1930 and had produced only 4 books by 2002. In 2001, the project was redefined as *Norsk Ordbok 2014*, and it was decided to complete the 8 remaining books in only 13 years, a plan which at the time of this writing is about to be fulfilled. I joined the project from the letter *k*- (in the 6th book) in 2005, and since then, I have edited the entries for prepositions such as *med* 'with,' *mellom* 'between,' *mot* 'against/towards,' *opp*⁴⁵ 'up,' *på* 'on,' *rundt* 'around,' and *åt* 'to.'⁴⁶

⁴⁵ *Opp* 'up' is classified as an adverb in the NO, in which traditional grammatical terminology is used. This also means that traditional prepositions are classified as adverbs when used as particles. I discuss some problems with this terminology in Aa (2011).

⁴⁶ From any dictionary, one easily gets the impression that prepositions are highly polysemous, since they can cover several pages with their numerous meanings. In chapter 4, I will argue the opposite, at least that their grammatical meaning is constant, and that their different lexical meanings are attributed to them based on context, interpretation and world knowledge (cf. Bouchard 1995; Tyler & Evans 2003; Anderson 2010; Aa 2012, 2013, 2014). *Opp* 'up' is frequently used as a particle, and we will see that its interpretation is also affected by its participation in LPrt and RPrt, i.e., the structural semantics. The distinction between concrete/directional and metaphorical constructions will also be relevant throughout the thesis. In addition to *opp* 'up', there will be a certain focus on the semantics of *med* 'with' (in chapter 6). We will see that *med* 'with' has special syntactic properties that can be seen in connection with its basic (grammatical) semantic content, which expresses *juxtaposition*. This is an important claim in this thesis: The grammar-semantic properties of a preposition are structurally relevant, while its specific interpretation in a given context is not.

It should be noted that the relevance of the NO for this project is not limited to what is found in the actual dictionary. From the NO website,⁴⁷ there is open access to *Metaordboka* ‘the meta dictionary’, in which a lot of the dialect material is found. In *Setelarkivet* ‘the archive of cards’, we find an archive of dialect material (and excerpts from books and papers) that has been systematically collected from the 1930s until today, but which contains much older material, as mentioned above. The cards from before the NO 2014 project was begun are handwritten and were later scanned so that they are accessible on the web today. The cards from the more recent years are directly registered into the database. The total number of cards at the end of the year 2012 was 3,2 million, but the number is increasing continuously. This also means that the number of cards connected to a given lemma is also increasing. By 2014, there were about 3600 *med* ‘with’ cards, 1900 *opp* ‘up’ cards and 5000 *på* ‘on’ cards. Many of these cards contain dialect material, either handwritten directly by an informant or, e.g., through books on local cultural history from different areas or regions. When working with this material, the editors of the NO must evaluate the reliability of the informants who contribute with data from their own dialect. Some informants apparently report more from Aasen’s (1850, 1873) dictionaries than from their actual home village, while others will refer to Aasen just to confirm that a specific usage mentioned there is also present in their dialect. The latter of these two strategies is arguably the more interesting for the NO (and this thesis).

In sum, the amount of dialect material collected during the last 80 years is vast, and I will take advantage of the fact that I have worked with and sorted out much relevant material during the work with the prepositions mentioned above. The NO material will be discussed continuously in the relevant sections. To have a look at the relevant lemmas in the NO mentioned above, e.g., *opp* ‘up’ and *med* ‘with’ (which will be relevant in chapters 4–6), I encourage the reader to search them up in the NO online.

1.4.5 Norwegian Dialectological Sources

In addition to the above-mentioned data sources, I will also take advantage of the data in earlier Norwegian dialect-oriented literature. In earlier analyses of VPrt constructions, I think that the Norwegian dialectological sources have been ignored too much, and instead, too much attention has been paid to the apparent free alternation in the written standards. Dialectological references are a key to understanding this issue. First, not surprisingly, they

⁴⁷ See <<http://no2014.uio.no/>> (accessed September 2014).

highlight differences between the spoken varieties and the written standards, including syntactic ones. Second, they are empirical works which in a more or less arbitrary manner document variation, not necessarily with theoretical ambition. I consider this to be an advantage in the sense that they are less selective with the data; they do not provide only data that support a certain analysis. Works that are basically theoretically oriented can also be more selective with the data presentation, since not everything is relevant for their particular analysis. An empirical dialectological presentation of a wide range of data is a great starting point for a project like this. I consider Aasen (1848, 1864) and Sandøy (1976) particularly interesting for my work. Sandøy (1976) is more selective in the sense that it is a thesis about VPrt, but it is very empirically founded and not theoretically driven.

1.5 The Structure of the Thesis and Summary of the Research Questions

The thesis is organised as follows. In chapter 2, I will present earlier and more recent data. In the standard construction, we will see that LPrt distribution clearly dominates. I will also present other data, for which the alternation problem is less relevant. The oldest modern Norwegian data that I include are Ivar Aasen's findings from the 1840s. The most recent and equally most important data are taken from the NDC.

In chapter 3, some important previous theoretical accounts from the literature on particles will be discussed, and I will focus first and foremost on small clause accounts from the early 1980s onwards, i.e., Taraldsen (1983), Åfarli (1985), den Dikken (1995), and Svenonius (1996a). I will also include a major work on what I refer to as the complex predicate account (borrowing Ramchand & Svenonius' 2002 term), namely Zeller (2001), where the particle is analysed as a lexical complement of V (and V and the particle are assumed to be structurally adjacent). Chapter 3 eventually closes with Ramchand & Svenonius' (2002) and Ramchand's (2008) *lexical*-syntactic model, where the particle identifies a resultative node in a decomposed VP structure. All of the selected works include Norwegian in their discussion, and in my review of them, the two decisive questions from section 1.1.1 will be in focus: *What is the basic word order? How are the two alternative word orders derived?*

Chapter 4 is the main analytical chapter. Here, I will outline an analysis which to begin with is based on the SC tradition and argues for a predicational VPrt structure. One of my main goals will be to account for the difference in meaning between LPrt and RPrt; I will

argue that LPrt constructions are more dynamic than their RPrt counterparts. The dynamic reading facilitates a weakening of the DP–Prt predication, which means that only RPrt constructions are true resultatives. A dynamic–resultative distinction also harmonises with Aasen’s (1848, 1864) colloquial Norwegian data, and with Sandøy’s (1976) data from the Romsdal dialect. Chapter 4 is where most of the data puzzles from chapter 2 (cf. also the data in 1.1.2) are analysed theoretically. Two main options will be discussed, cf. the regulation of structural variation discussed in 1.3.5:

- (41) **Structural variation** is regulated
- a. on the phrase structure level, and
 - b. by different operations applying to the same phrase structure.

First, I will account for the particle alternation in a traditional derivational model, where particle movement is a central ingredient, cf. (41b). Then I will discuss the possibility that LPrt and RPrt constructions differ in phrase structure, cf. (41a), and that the data should be explained in a representational model. That will be the working hypothesis from section 4.3 onwards. In this chapter, I will also discuss the Mainland Scandinavian micro-variation in the model that I am pursuing. I will end chapter 4 by discussing whether the Norwegian particle alternation is a possible outcome of bilingualism, i.e., of two separate grammars (cf. Hoekstra 1992, den Dikken 1992).

Chapter 5 discusses a second group of VPrt constructions where RPrt is completely impossible, and also VPrt constructions involving unaccusative verbs. The former group has previously been discussed in Ven (1999), while the unaccusatives have not been discussed earlier, to my knowledge. The aim of this chapter is to provide more data to the hypotheses outlined in section 4.3.

In chapter 6, I discuss some complex constructions initiated by the preposition *med* ‘with’. *Med* can take more complex complements than other prepositions, be it SCs with and without relativisation, and complex VPrt constructions. I ascribe this to *med*’s basic semantics of juxtaposing two elements (Anderson 2010, Aa 2013), and I will explore the meaning and consequence of the juxtaposition term.

Chapter 7 concludes the thesis.

Summary of the Research Questions:

RQ 1: Is it the case that LPrt and RPrt constructions are semantically distinct and that LPrt constructions are generally preferred in Norwegian, and what do the semantic and grammatical differences consist in more precisely?

RQ 2: What is the nature of the syntactic structure and derivation regarding Norwegian VPrt constructions?

RQ 3: How can the interplay between structural, lexical and non-linguistic meaning best be integrated in an analysis of Norwegian VPrt constructions?

RQ 4: How should the syntactic and semantic differences between directional and metaphorical structures be modelled in an analysis of Norwegian VPrt constructions?

RQ 5: Why is the RPrt pattern generally preferred when there is an additional resultative PP complement to the VPrt?

RQ 6: How should the so-called Group 2 VPrt constructions be analysed in order to account for their basic syntactic and semantic differences as compared to Group 1 VPrt constructions?

RQ 7: What are the basic structural properties of unaccusative VPrt constructions, and can their basic properties be assimilated to the properties of either Group 1 or Group 2 VPrt constructions?

RQ 8: Why does *med* 'with' used as a VPrt license a more complex structure than do the other VPrts, and what are the syntactic and semantic properties of VPrt constructions involving *med* 'with'?

RQ 9: Why and to what extent are Swedish VPrt constructions structurally different from Norwegian ones, and how could the differences be analysed structurally?

RQ 10: Is it possible that the contemporary Norwegian VPrt patterns can be the historical outcome of the influence of the Danish VPrt pattern on a traditional domestic Norwegian pattern?

Notice that RQ 9 and 10 are treated just in a preliminary way in this thesis.

2 Norwegian Verb-Particle Data

In this chapter, I will look at both older and contemporary data representing several different types of verb-particle (VPrt) constructions. The earliest Modern Norwegian data that I include are Ivar Aasen's findings from the 1840s, presented in his two grammar books (Aasen 1848: § 335, 1864: § 334). The former of these is descriptive,⁴⁸ and the latter is the first prescriptive *Nynorsk* grammar.⁴⁹ But since the norms of the 1864 grammar are so tightly connected to the data from spoken varieties, it is also relevant here. Throughout the 20th century, most grammars that included VPrt constructions dealt with (one of) the written standards. Heggstad (1931: § 425–429) and Beito (1970: § 153) describe some empirical facts about particle verbs in *Nynorsk*, while Western (1921: § 454) has a corresponding section in his *Riksmål/Bokmål* grammar. All these grammars primarily deal with the difference between particle verbs and prefix verbs, and Beito also discusses compound verbs in general.

When it comes to comparative syntax, Hulthén's (1948) work is quite remarkable. He provides a systematic grammatical comparison of the Mainland Scandinavian written languages, including a section on VPrt constructions. However, the most important "early" work for our purposes is Sandøy's (1976) comparative study of VPrt constructions in Romsdal Norwegian, Faroese and Icelandic (and Old Norse). This is to my knowledge the most thorough systematic empirical work on VPrt constructions in Scandinavian dialectology. The new aspect of this thesis is that it primarily deals with syntactic variation in spoken language. Aasen's and Sandøy's findings are of great importance and serve as the inspiration for my analysis in chapter 4. My own findings from the pilot fieldwork in Trøndelag and Nordmøre (see section 2.1) basically confirm what Aasen and Sandøy already noted. The main data source upon which I will build my theoretical argumentation is the *Nordic Dialect Corpus* (NDC) (Johannessen et al. 2009) (cf. 1.4.3.2), which includes much more material than is possible to collect on one's own during the time frame of a PhD study.

The chapter is organised thematically as follows. In section 2.1, I will discuss what I refer to as standard VPrt constructions. These constructions include a transitive verb, and

⁴⁸ However, Walton (1996: 424) claims that the 1848 grammar and also the 1850 dictionary were actually more prescriptive than traditionally claimed, and that Aasen's aim to systematise the collected material triggered the standardisation already during the fieldwork.

⁴⁹ As mentioned in section 1.1.4, *Nynorsk* was named *Landsmål* until 1929, but we generally use the *Nynorsk* term here for ease of exposition.

particle alternation is generally possible, which is the reason why they are discussed most often in the linguistic literature on the North Germanic languages. Section 2.1 will differ from the other sections in that it also discusses the relevant sources and methods. In section 2.2, there is a short note on the word accent of V + LPrt constructions. Section 2.3 discusses complex particle constructions, in which we see a (resultative) PP complement in the right periphery. In 2.3, I also include a sub-section on complex phrasal particles. Section 2.4 introduces a second group of VPrt constructions, in which LPrt is obligatory. Section 2.5 discusses constructions in which the particle combines with an unaccusative verb. In section 2.6, we see that *med* ‘with’ can introduce more complex VPrt constructions than other particles. Finally, section 2.7 concludes the chapter.

2.1 Standard VPrt Constructions

This section discusses standard VPrt constructions, namely those which involve a full DP, and also introduces my data sources more in detail. Subsection 2.1.1 presents earlier empirical overviews (theoretical accounts will be discussed in chapter 3). Subsection 2.1.2 discusses prior work on the NDC, and provides details concerning the search interface (2.1.2.1), the specific searches undertaken for this project (2.1.2.2) and the results obtained (2.1.2.3). 2.1.3 elaborates on my pilot fieldwork in Trøndelag and Nordmøre, actualising some of the general problems discussed in 1.4.2.

2.1.1 Previous Accounts

In comparative studies of the particle distributions in the Scandinavian languages, the optionality in (1c) below is usually presented as the situation for Norwegian. To the best of my knowledge, the first work that gave an overview of VPrt constructions in all the Mainland Scandinavian languages was by Hulthén (1948: 159–168). This work is mainly concerned with the written standards, and includes both of the Norwegian standards *Nynorsk* and *Bokmål* in the discussion. Thráinsson (2007: 34, 142) gives a more complete Scandinavian overview, with the inclusion of Faroese and Icelandic. Thráinsson’s data are given in (1),⁵⁰ and his presentation of the Mainland Scandinavian languages corresponds with the claims made by Hulthén (1948).

⁵⁰ Thráinsson also includes light pronoun constructions in his overview, but they will not be discussed here.

- (1) a. **Danish:** Jeg skrev {*op} nummeret {op}.
 I wrote {up} the number {up}
 ‘I wrote down the number’
- b. **Swedish:** Hon kastade {ut} Johan {*ut}.
 ‘She threw {out} John {out}’
- c. **Norwegian:** Han spiste {opp} tørrfisken {opp}.
 He ate {up} the dryfish {up}
 ‘He ate up the dried fish’
- d. **Faroese:** Hann gjørdi {upp} snørið {upp}.
 ‘He wound {up} the line {up}’
- e. **Icelandic:** Ég skrifaði {niður} símanúmerið {niður}.
 I wrote {down} the telephone number {down}
 ‘I wrote down the number’

A potential problem with (1) is that directional (predicational) and metaphorical (non-directional/idiomatic) examples are arbitrarily mixed. The Swedish and Faroese examples are directional, while the others are metaphorical. We will see later that this distinction matters for the distribution of the particle.⁵¹ However, Danish and Swedish show the most rigid patterns; Danish allows only RPrt, and Swedish only LPrt. Norwegian, Faroese and Icelandic all show optional VPrt distribution according to (1).

Regarding Norwegian, there is reason to believe that (1c) represents first and foremost the standard written conventions; at least Hulthén (1948) is clear about that he is commenting on written sources. Importantly, Ivar Aasen’s data of colloquial Norwegian from the 1840s speak to a different conclusion than what is suggested by the Norwegian pattern in (1c). Aasen (1848) claims that both intransitive prepositions (§ 334) and directional adverbs (§ 335) (directional Ps in our terminology) are generally distributed in front of the verb’s object,

⁵¹ This is the case at least for Norwegian. In Swedish and Danish, the patterns are more rigid, and the directional/metaphorical distinction is not necessarily so relevant, at least not in full DP constructions. See Vinka (1999) for a distributional difference in light pronoun constructions concerning (in his terms) predicative vs. non-predicative constructions.

when the object is a noun. In other words, LPrt distribution could seem to be the unmarked pattern for Norwegian full DP constructions. All the examples in (2) are Aasen's:

- (2)
- a. Me ha lagt paa ein Stein.
we have put on a stone
'We left a stone on it'

 - b. Dei tok fraa Hesten, set fyre Hesten, slepp ut Hesten
they took from the horse / set ahead the horse /let out the horse
'They loosed the horse' / 'place the horse in front' / 'let out the horse'

 - c. Dei ha' havt inn Høy'e.
they have had in the hay
'They have taken in the hay'

 - d. Han slo av Staven.
he hit off the stick
'He broke the stick'

 - e. Eg talde upp-atte Penganne.
I counted up-back the money
'I counted the money over again'

Aasen (1864: § 334–5) repeats the claim that LPrt distribution (in our terms) is the unmarked pattern, and he formulates the LPrt distribution as a prescriptive rule.⁵² But he adds some important exceptions. Particles (adverbs) which describe place or direction can be right-handed, especially in a written context, to promote a contrastive meaning. However, in spoken language, a prominent⁵³ LPrt has the same effect. This discussion became relevant to Aasen when he was establishing the *Nynorsk* written language. His 1864 grammar is thus a *Nynorsk* prescriptive grammar, while his original 1848 grammar is commonly assumed to be

⁵² Aasen's words: "Den Regel at Adverbiet skal sættes forved et Substantiv, ..." 'The rule that an adverb should be distributed in front of a noun, ...' (my translation).

⁵³ By *prominent* I mean prosodically prominent, i.e., that the word bears phrasal stress in the sentence (cf. Nilsen 2003).

a descriptive grammar of the Norwegian spoken language (“det norske Folkesprog”) (see Walton 1996: 503ff for an extended discussion).

An interesting detail concerning Aasen’s informants from the 1840s is that they must have been something close to “ideal” dialect speakers – not influenced significantly by the standards of the written Danish. Today, Norwegian speakers are massively exposed to other dialects and to other languages such as English, and therefore they can count as multilingual (Vulchanova et al. 2012). Fet (1995, 2003) documents that many Norwegian peasants were actually capable of reading in the 18th century, which is earlier than commonly assumed. The writing ability developed much later, among others because there was no compulsory writing instruction in school until the Education Act of 1827. Fet assumes that 12–24% of the Norwegian population were able to write around 1800, but that the Education Act of 1827 enhanced writing ability among the population (see an English summary of Fet’s work in Fet 2003: 387ff). Still, we must assume that the general writing ability (at least among older people) was not high already in the 1840s. Torp & Vikør (2003: 114) claim that children’s general writing ability improved significantly around 1880–1900. If we assume that pupils were introduced to the Danish pattern (1a) regularly from 1827, at least Aasen’s older informants probably represented an “unspoilt” and “true” system of spoken modern Norwegian. Of course it is difficult to measure the influence Danish could have had on people’s spoken language. But once they were able to produce the Danish pattern on paper, there was further potential for influence. We will discuss the possible bilingual effect of writing in section 4.6.

Western (1921: § 454) claims that the RPrT construction *Lægen satte benet av* ‘the doctor put the leg off (down)’ was “transferred” from German (*Der Arzt setzte das Bein ab*). There might be some borrowings from German in Norwegian, but we must assume that the early written *Riksmål/Bokmål* more or less showed the same word order pattern as Danish. Interestingly, Western (loc.cit.), like Aasen, claims the LPrT variant *Lægen satte av benet* ‘the doctor put off (down) the leg’ to be the Norwegian word order,⁵⁴ but it is unclear to me whether this is a description of spoken Norwegian, an advice for writers of *Riksmål*, or both. He does give more explicit details on spoken language, e.g., light pronoun LPrT constructions (*Han satte av det* he put off it ‘He put it off’), which he finds inappropriate in the educated

⁵⁴ “Den norske ordstilling er *lægen satte av benet*, når objektet er trykksterkt ...” ‘The Norwegian word order is *the doctor put off the leg*, when the object is prominent’ (my translation).

Riksmål speech, and which one presumably should avoid writing.⁵⁵ The interesting part here is that a sociolectal distinction is established, and thus we can assume that some speakers would switch between the patterns. A switch between the grammar of the local dialect and, e.g., that of the urban East Norwegian “standardised” dialect and/or the *Bokmål* standard is relevant still today (cf. Eide & Åfarli 2007). With our simplified definition of a dialect in 1.4.3.2, we must assume more social variation and input from the written standards than our definition captures. The definition is repeated here:

- (3) A dialect is a geographically based language system different from other geographically based language systems, and different from the relevant written (and spoken) standard(s).

The informant selection criteria of the NDC (see 1.4.3.2) also minimise the internal and social variation on each measure point. We must still keep that in mind.

As mentioned several times already, Sandøy’s (1976) work is of great importance for this project. In particular, on pp. 88–113, he reports an interesting pattern for the West Scandinavian languages which forces us to revise (1c) and also (1d). According to Sandøy, Faroese has a clear RPrT preference; LPrT and RPrT seem to be in free variation only when the particle apparently constitutes a fixed expression with the verb (and the meaning of the particle is apparently blurred). Nearly the opposite is the case for the Romsdal dialect (Northwest Norwegian), in which LPrT is clearly preferred as the unmarked alternative, and RPrT can only occur when the verb, the particle or the DP is prominent. Usually, the direction is emphasised in a given RPrT construction. Metaphorical constructions allow LPrT distribution in Faroese and have obligatory LPrT in Romsdal Norwegian. The particle itself in such idiom-like, fixed expressions is often claimed to have a very vague meaning,⁵⁶ and typically cannot be replaced by other particles.⁵⁷ Some of Sandøy’s examples from his pp. 107f are given in (4) (the use of curly brackets is mine):

⁵⁵ “Dialektisk sies endog *han satte av det, han fyrte av det*, men det kan neppe sies å tilhøre den dannede riksmåls-uttale.” ‘In the dialects, one would still say ‘*he put off it, he fired off it*’, but it can hardly be said to belong to the educated *Riksmål* speech’ (my translation).

⁵⁶ In chapter 4, I will claim that the semantics of the particle is constant, and that the *distribution* (the structural semantics) of the particle on the one hand and the *context* and our *world knowledge* on the other contribute to our *interpretation* of the particle, though they do not change the meaning of it. I will also suggest a formalisation of idiom formation.

⁵⁷ In chapter 4, we will see that this diagnostics is too strict.

- (4)
- a. Han he rekna {+ut} prisan {*ut}.
 he has calculated {out} the prices {out}
 ‘He calculated the prices’
 - b. ... korleis me laga {+te} mat {*te}.
 ... how we make {to} food {to}
 ‘... how we prepare the food’
 - c. Han las {+opp} brevet {*opp}.
 he read {up} the letter {up}
 ‘He read the letter loudly’
 - d. I gløymte å legge {+fram} detta beviset {?fram}.
 I forgot to lay {ahead} this evidence {ahead}
 ‘I forgot to show the evidence’

The main rule for Romsdal Norwegian is that LPrt is certainly preferred, but RPrt is allowed in certain combinations, as in (4d).

In Sandøy’s comparison with the Insular Scandinavian languages, it turns out to be hard to generalise a rigid pattern for Icelandic. Smári (1920: § 165) claims that LPrt distribution is the typical pattern, but that RPrt is also possible. Sandøy does not find support for this rule in his material. In fact, he spots a slight preference for RPrt if the DP is a determinative. If the particle is combined with a bare noun, there is a slight preference for LPrt. His informants do not provide any clear answers, except in one case, where an informant notes that LPrt constructions emphasise the DP, and RPrt constructions stress the meaning of the verb (action) or the particle (direction).

Given Sandøy’s observations, I think it would be more accurate to modify the judgement pattern in (1c, d, e) to (5a, b, c), although it is still a very simplified representation. From the discussion above, it appears that Icelandic might be more nuanced than (5c) indicates. Sandøy (1985: 102) provides an “updated” treatment of Icelandic in line with Smári (1920): a general preference for LPrt is claimed. I have not marked this in (5c). Instead, I will leave the Icelandic question open. However, I *have* followed Sandøy’s (1985) report on Norwegian, in which he claims that most dialects (and not only the Romsdal dialect) prefer LPrt.

(5) a. **Norwegian:** Han tok {+inn} sykkelen {-inn}.

he took {in} the bike {in}

‘He carried the bike inside’

b. **Faroese:** Hann gjørði {-upp} snørið {+upp}.

He wound {up} the line {up}

‘He wound up the line’

c. **Icelandic:** Ég skrifaði {niður} símanúmerið {niður}.

I wrote {down} the telephone number {down}

‘I wrote down the number’

Although the Norwegian pattern is claimed by Sandøy (1985) not to be equally “rigid” in all dialects, there is reason to believe that the LPrt preference is the general rule for Norwegian, and that “optional distribution” is rather the exception, representing a smaller number of dialects.⁵⁸

2.1.2 *The Nordic Dialect Corpus*

2.1.2.1 Search Interface

As mentioned in section 1.4.3.2, the Norwegian part of the Nordic Dialect Corpus (NDC) (Johannessen et al. 2009) includes conversations and interviews with almost 440 speakers from 111 measure points (Johannessen & Hagen 2014: 17). In such a large corpus, a proper search interface is important in order to limit the number of irrelevant search results. First of all, we can search for word classes and lemmas (Johannessen et al. 2009: 75), which in the case of VPrt constructions provides us with all inflected forms of the verb and the DP (when it is an appellative noun). This should enable us to see whether there is a pattern of LPrt or RPrt being preferred with indefinite or definite DPs. Johannessen et al. (2009) outline a number of possibilities for searching the corpus that I will not go into here. A crucial detail

⁵⁸ In English, the “optional distribution” is well established in the literature. Therefore, Fraser’s (1976: 18) empirical generalisations are interesting. Here, he claims that LPrt is preferred “when the noun phrase is very short, consisting of a single word such as *John*, *water*, or *problems*, ...” Thus, *He heated up water* is preferred over *He heated water up*.

for syntacticians is that the corpus is parsed, so it is possible to search for word strings. In the VPrt context, we can search for the word strings like the ones in (6):

- (6) a. [inflected verb] + [prep] + [inflected noun]
 b. [inflected verb] + [inflected noun] + [prep]

We do not have to specify the verb or noun lemma in the word string, but it might be a good idea to specify the preposition, which I will return to in 2.1.2.2. The search platform looks like the following screenshot:

(7) **The NDC search platform**

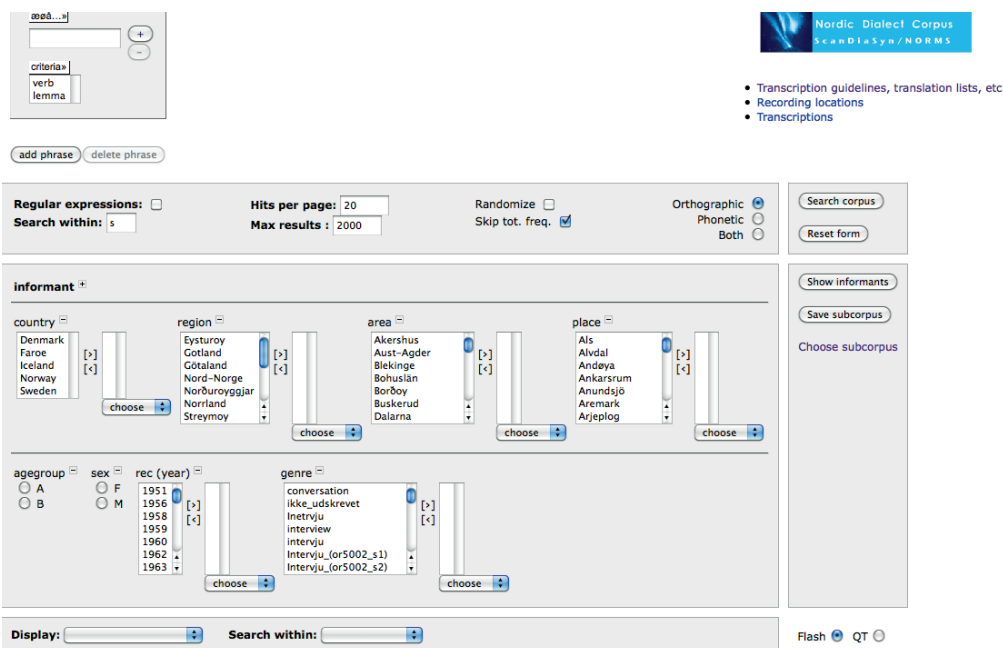

There are many geographical options that can be used to limit the search; we can specify country, region, area and place. In this project, since my primary focus encompasses Norwegian VPrt constructions, a country restriction is usually appropriate.

As mentioned in section 1.1.3, one of the reasons for making a Nordic dialect corpus was that all five Nordic countries/areas plus the Swedish speaking part of Finland can be considered to be one big dialect continuum. All six of the relevant written standards

(Icelandic, Faroese, Swedish, Danish, *Nynorsk*, and *Bokmål*) are closely related. There is mutual intelligibility between the mainland languages, and between the two insular languages. Between the mainland and the insular languages, there is some mutual intelligibility, at least between the written forms (cf. Johannessen et al. 2009: 74).⁵⁹ Hence, one could well argue that an investigation that crosses borders to a greater extent is more appropriate for this study. We saw in 2.1.1 that Norwegian, Faroese and Icelandic are traditionally claimed to have free particle alternation. But by taking the dialectological literature into account, we could use the claim that there is no free particle alternation in Norwegian to motivate a new investigation of Faroese and Icelandic too. There are already some indications from Smári (1920) and Sandøy (1976, 1985) that the Icelandic and Faroese alternation is not free.

In spite of this, I will keep my studies mainly within the Norwegian borders and consider the other languages only in passing. One reason for this is that the alternation problem is only one of several empirical issues that I will discuss. I have already mentioned that from section 4.3 onwards the alternation problem will be less prominent. By keeping the focus restricted to Norway, I can include a wider range of data, and the data discussion can be more detailed and sophisticated. There are many interesting phenomena in the Norwegian VPrt typology that have not been discussed before, and I think my best opportunity to make a substantial contribution in the VPrt area is to concentrate on the chosen phenomena. The diversity found within Norwegian is quite substantial, and hopefully some of my findings and discussions can trigger (re)investigations of related languages.

2.1.2.2 The Specific Searches

An extended search of the NDC has provided a lot of data from across the country that I would never have been able to collect on my own. As mentioned, the corpus allows us to search for word strings and to specify morphosyntactic criteria for each word. In the search for prepositional VPrt constructions, I have specified the directional prepositions *ut* ‘out’, *inn* ‘in’, *opp* ‘up’, and *ned* ‘down’. This resulted in a good amount of data, but still an amount that is manageable. I know from my dictionary work (see section 1.4.4) that these prepositions are frequently used as particles, and more rarely (I would estimate around 2–3% of the cases)

⁵⁹ Written Faroese is quite intelligible in the neighbouring countries due to V.U. Hammershaimb’s (1819–1909) archaic standardisation from the 19th century. If Faroese were standardised more orthophonically (i.e., based on one of its spoken varieties), it would be less intelligible outside its borders (cf. Sandøy 1974: 14, Skomedal 1980: 88).

used as transitive prepositions.⁶⁰ This means that almost all results of a search with the specifications in (6a) will be relevant. On the other hand, prepositions like *i* ‘in’, *på* ‘on’, and *med* ‘with’ are mainly used transitively, so the search string in (6a) will give mostly irrelevant results. Since these prepositions are also very frequent, the total number of irrelevant results will be vast.

As mentioned in 1.4.4, I edited both *på* ‘on’ and *med* ‘with’ for *Norsk Ordbok* (NO) and thus systematically studied them in *Nynorskorpuset* (‘The *Nynorsk* Corpus,’ which contains more than 100 million words, cf. 1.4.3.1). One of the conclusions from this work was that when *på* ‘on’ is used as a particle, it typically combines with an unaccusative verb – either a meteorological verb denoting something like an increasing wind or clouding (*lette* ‘lighten’, *auke* ‘increase’, *friske* ‘freshen’, *kvikne* ‘quicken’, *tjukne* ‘thicken’ *på* ‘on’), or a verb denoting movement or duration (*gå* ‘go’, *køyre* ‘drive’, *fly* ‘fly’, *røyne* ‘tire’, *stå* ‘stand’ *på* ‘on’). As we will see in section 5.2, particle alternation is not relevant for these constructions. There are of course *på* ‘on’ combinations with a transitive verb too (e.g., *slå {på} lyset {på}* hit {on} the light {on} ‘turn on the light’), but these are very few in number compared to all the examples we would have to ignore in a corpus study of particle alternation.⁶¹

The advantage of focusing on the four directional prepositions is that they all are frequently used as particles (irrelevant results are minimised, so we get manageable results), and they are used in plenty of different metaphorical constructions in addition to concrete directional constructions. They also combine with a lot of verbs, both semantically specific and more “vague” (or polysemous) ones. All in all, I think they represent an essential sample of the prepositional particles used in Norwegian.

In the NDC, I have searched for the eight strings schematised below (limiting myself to the Norwegian dialect area):⁶²

⁶⁰ In Swedish, the selected prepositions cannot be adnominal at all and are hence construed as directional adverbials. Lundquist (2012) suggests that the Norwegian variants are only apparently adnominal and take a null preposition: *They carried him up Ø the stairs*. In Aa (2011), I discuss the categorisation of prepositions and adverbs in a dictionary setting.

⁶¹ See NO’s online version <<http://no2014.uio.no>> (accessed September 2014) *på*. The particle version is shown in the adverb article, **I på**. The choice of the adverb category for particles is discussed in Aa (2011).

⁶² Since the corpus is transcribed in each country’s respective standard orthography (i.e., *Bokmål* for Norwegian, see 1.4.3.2), we can limit the search by specifying at least one of the words in the string. If we specify the preposition *opp* ‘up’, we have already excluded all but Norwegian (in Icelandic, Faroese and Swedish, the corresponding preposition is *upp* while in Danish it is *op*).

- (8) a. Verb + *ut* 'out' / *inn* 'in' / *opp* 'up' / *ned* 'down' + noun
 b. Verb + noun + *ut* 'out' / *inn* 'in' / *opp* 'up' / *ned* 'down'

This means that I have not searched for prominent pronouns, although they would also count as full DPs. When I present the results in 2.1.2.3, I will specify the directional and metaphorical constructions. I assume that all of the four particles in (8) have a basic directional meaning, and that all other uses are derived from this meaning. All of the particles have a huge spectre of contextually based (and maybe idiomatic) interpretations. For example, one of *opp*'s interpretations is 'open':⁶³

- (9) få opp knuten
 get up the knot
 'open the knot'

- (10) lukk opp døra
 lock up the door
 'open the door'

Sandøy (1976: 105f) stresses the difference between *bere ut* 'carry out' and *dele ut* 'hand out'; only the former expression expresses directionality. This means that when *ut* combines with *dele*, it has a non-directional interpretation. In section 4.3.4, I will claim that *ut*'s basic semantics is always directional (see also 2.1.2.3 below). The semantics of the verb and the DP contribute to our interpretation of the particle, and thus to the interpretation of the construction as a whole. Below, I go more into details concerning the results of my searches of the NDC, and I will discuss more in detail what I mean by directional vs. metaphorical constructions.

2.1.2.3 Results

As mentioned in 2.1.2.2, I searched for LPrt and RPrt occurrences with *opp* 'up', *ned* 'down', *ut* 'out', and *inn* 'in' in the NDC. Thus, I obtained plenty of both directional and metaphorical results. In some cases it can be hard to draw a clear line between these two categories, but I

⁶³ In section 4.3.4, I will discuss the semantics of prepositions more thoroughly, in light of Bouchard's (1995) theory of Grammar and Situational semantics.

have tried to judge each and every sentence gathered in the searches. I will assume that all of the four relevant particles have basic semantics which expresses some kind of physical direction:

- (11)
- a. *ut* ‘out’ – ‘to a point outside or further out (*ute_{LOC}*)’
 - b. *inn* ‘in’ – ‘to a point inside or further in (*inne_{LOC}*)’
 - c. *opp* ‘up’ – ‘to a higher (physical) level’
 - d. *ned* ‘down’ – ‘to a lower (physical) level’

I will discuss more thoroughly in section 4.3.4 what is meant by basic semantics. Here, it will suffice to state that all examples which entail a directionality compatible with the basic semantics of the particle are by definition directional. All examples which do not entail a directionality compatible with the basic semantics of the particle are metaphorical. A simple pair is given in (12):

- (12)
- a. **Directional:** kaste ut boka
‘throw out the book’
 - b. **Metaphorical:** lese ut boka
read out the book
‘finish the book’

(12a) is compatible with (11a); the book ends up on a point outside or further out as a result of the throwing. (12b) is not compatible with (11a); the book does not end up on a point outside or further out as a result of the reading. This is basically what qualifies (12a) and (12b) as directional and metaphorical, respectively. Using these criteria, we can look at some examples from the NDC of directional constructions in (13), and of metaphorical constructions in (14). I have included LPrt and RPrt constructions in both groups, although the RPrt alternative is quite rare in the second group (cf. the table in (16) below).

- (13) **Directional constructions**
- a. de **setter kjelene ned** (Bømlø)
‘they put the boilers down’

- b. vinduet stod åpent så jeg kunne **ta ut hånda** (Hjelmeland)
 the window stood open so I could take out the hand
 ‘the window was open so I could stretch out my hand’
- c. **saga ned trær** og laga benker (Hyllestad)
 sawed down trees and made benches
 ‘sawed down some trees and made benches (of them)’
- d. vi **bar inn ved** (Lom)
 we carried in wood
 ‘we carried the wood inside’
- e. du **satte beina ned** (Vegårshei)
 ‘you put your legs down’
- f. jeg ... **slipper ankeret ut** (Hammerfest)
 ‘I ... let the anchor out’
- g. det er nå ... fire fem andre naust der som **tar inn båtene** (Bud)
 there are now ... four five other boathouses there that take in the boats
 ‘there are four or five other boathouses there, which house the boats’

(14) **Metaphorical constructions**

- a. **bytte ut bilen** med sykkel (Herøy)
 change out the car with bike
 ‘change the car for a bike’
- b. **følge opp dyra** (Alvdal)
 follow up the animals
 ‘take care of the animals’

- c. de **sang inn jula** (Aremark)
 they sang in Christmas
 ‘they sang in the Christmas season’
- d. de får **samla opp pengene** (Karmøy)
 they get collected up the money
 ‘hey managed to collect the money’
- e. de kan **plukke ut narvikværingene** (Steigen)
 they can pick out the Narvik citizens
 ‘they can spot the citizens of Narvik’
- f. han ... **la opp ruta for dagen** (Flå)
 he ... laid up the schedule for the day
 ‘he planned the schedule for the day’

As we have seen through Sandøy (1976), directionality is a structurally relevant criterion; metaphorical RPrT constructions are rare, and for some speakers even impossible. Therefore, I have tried to separate directional from metaphorical VPrT constructions in the corpus results, to investigate whether this tendency is relevant across the country. Many examples, like the ones given in (13) and (14), are easy to classify as either directional or not. But it is important to keep in mind that there are also examples that are more difficult to classify. Here are two such examples from the NDC:

(15) **Grey area examples**

- a. amerikanere som **sender inn videoer** som de har filma sjøl (Suldal)
 Americans that send in videos that they have taped self
 ‘Americans who send in their videos, which they have taped themselves’
- b. det **blomstrer opp hytter** (Vang)
 it flourishes up cabins
 ‘many cabins are raised’

Both of these examples should probably be characterised as metaphorical, but they also have a sense of directionality. In (15a), videos are sent from the outside world into an institution, which is probably located inside a building; however, the expression does not express such ‘from outside to inside’ directionality. Therefore, it must probably be construed as metaphorical. (15b) is interesting because the verb is definitely metaphorical (cabins don’t flourish), but the particle can still have a directional reading (the cabins are raised up from ground level). Therefore, this example is not completely clear.

Obviously, the degree of abstractness varies in many examples. We could be more specific than simply classifying a structure as either directional or metaphorical and, e.g., follow a dictionary classification, where a lot more interpretations are elaborated upon in more detail. But if we draw a line and try to define what is structurally relevant, we will probably get a more simplified picture. This will be discussed in section 4.3.6. I will also discuss *opp* ‘up’ in more detail in 4.3.4.

The table in (16) sums up the directional and metaphorical results of around 400 constructions from the NDC, featuring the four particles mentioned in (11). They are separated into five Norwegian regions.⁶⁴

⁶⁴ The definition of the regions can be discussed from different linguistic criteria. In the table in (16), I have included Nordmøre in *Trøndsk* (since the Nordmøre dialects belong there, although the region belongs administratively to Møre og Romsdal county in West Norway). There are borderline cases for each regional dialect group (see, e.g., Dalen 2008: 18 for *Trøndsk*), but except for the case of Nordmøre, I have used the county borders for the regional groups. Thus, West Norwegian = the dialects in Rogaland, Hordaland, Sogn og Fjordane, and Møre and Romsdal (minus Nordmøre). South Norwegian includes the Agder counties (Aust-Agder has the West Norwegian vowel reduction in infinitives and weak feminine nouns (Sandøy 1985: 85f), but the East Norwegian word accent spell-out (Sandøy 1985: 69f). To make it simple, I have generalised both Agder counties geographically, as South Norwegian. However, usually South Norwegian is included in West Norwegian in the dialectology (see, e.g., Mæhlum & Røyneland 2013: 39f), and we might therefore add South Norwegian to West Norwegian in (16), too. But our geographical separation here at least allows us to see what is actually included from Agder in the NDC. *Trøndsk* = the spoken varieties in Nord- and Sør-Trøndelag + Nordmøre. North Norwegian = the dialects in the three northernmost counties, Nordland, Troms, and Finnmark. Finally, East Norwegian includes the dialects in Hedmark, Oppland, Buskerud, Telemark, Vestfold, Østfold, Akershus, and Oslo. We will not discuss borderline cases further, since they are not that relevant for the concrete measure points from where I have got results in the NDC.

(16) **Directional and metaphorical LPrt and RPrt constructions**

| | Dir. LPrt | Metaph. LPrt | Dir. RPrt | Metaph. RPrt |
|-----------------------|------------------|---------------------|------------------|---------------------|
| West Norw. | 30 | 47 | 4 | 3 |
| East Norw. | 53 | 59 | 8 | — |
| <i>Trøndsk</i> | 27 | 23 | — | — |
| North Norw. | 39 | 56 | 7 | — |
| South Norw. | 18 | 16 | 4 | — |

First, the table in (16) tells us clearly that metaphorical RPrt constructions are very rare. As a matter of fact, the only three examples I have found are West Norwegian. But more importantly, the NDC lends massive support to the hypothesis that LPrt is the unmarked pattern in Norwegian. This seems to be the case for all parts of the country. In the dialect area of *Trøndsk* (Trøndelag and Nordmøre), no RPrt constructions at all were found. One reason could be that this area is not as well covered as other areas (the total number of results is much lower than for North or East Norway, for example). South Norway is not that well covered either, especially not the coastal part (and the region is generally much smaller than e.g. East Norway). North, East and West Norway generally have the best coverage. In the particle context, that is a fairly good mix, since we would expect East Norway to contrast with North, and also West to some extent. In East Norway, the bias towards LPrt was expected to be strong, and 112 LPrt constructions vs. 8 RPrt constructions confirm this. All of the 8 RPrt constructions are directional (as expected), while 53 % of the LPrt constructions are metaphorical. Generally, the division between directional and metaphorical LPrt constructions is about 50/50, except in the north and the west, where it is closer to 60/40 in favour of the metaphorical VPrt constructions.

Most importantly, however, the table in (16) tells us that LPrt distribution is clearly the more frequent alternative for the standard VPrt construction all over the country. RPrt constructions are rarer, and only with a few exceptions, they are directional. The NDC does not give us any indication that there are Norwegian dialects with free particle alternation. However, we must not exclude the option that some dialects are less LPrt-bound than others, as noted by Sandøy (1985) and Svenonius (1996a). Svenonius (2010) claims that the particle alternates more freely in North Norwegian, and this is also the impression that I have from

some informants in Nordland and Troms. At least, they show a less clear LPrt preference than speakers of *Trøndsk*.

2.1.3 Pilot Fieldwork in Trøndelag and Nordmøre 2009–10

In my own fieldwork in the initial stages of this work, I visited six villages in Trøndelag and Nordmøre. Nordmøre borders Romsdal in the south, with Romsdal being the northernmost area of West Norwegian. Three of the villages from the pilot fieldwork are in Fosen (Bjugn, Stokkøya and Skaugdalen), a coastal area in the northwest of Sør-Trøndelag County. The two southern villages are Oppdal, which is the southernmost village in Sør-Trøndelag, and Surnadal, further west in the inner part of Nordmøre. The sixth and last village is Nordli in Lierne community, in the northeast of Nord-Trøndelag, close to the Swedish border. All are plotted on the map below.

(17) Measure points from the pilot fieldwork



All of the fieldwork was performed with the NORMS/ScanDiaSyn group, which was finishing data collection in the central part of Norway for the Nordic Dialect Corpus and the Syntax Database. My own purpose was to join the group at different “measure points” of *Trøndsk*, so that I could get an immediate impression of the particle distribution in a heterogeneous dialect area with both coastal and inland features, and East and West Norwegian influences.

The first fieldwork, in Fosen, was done before the official start of my PhD work, thus a lot of questions have arisen since. The Oppdal/Surnadal fieldwork was the most thorough; 4 younger and 4 older informants (both men and women) were interviewed in each village.⁶⁵ In Lierne, I only had time to interview 5 informants in total. In Fosen, I interviewed around 20 informants, but most of them were older people.

Because I engaged in this fieldwork at an early stage of the project, I met the speakers with an open mind, not really knowing what to expect. Although I had Aasen's (1848) observations in the back of my mind, I expected the informants not to have any particular preferences concerning leftward vs. rightward particle distribution. I had not thought of any potential differences between directional and metaphorical constructions, standard (simple) and complex constructions, etc. In general, I was more familiar with the linguistic literature than the dialectological literature at the time, which meant that the idea of free alternation was firmly rooted in my mind.

Since we had limited time and other linguists were taping and recording free speech (now available in the NDC), I decided to do oral grammatical elicitation tests during all the fieldworks. This was a consequence of having only one or two informants available at a time. All the informants judged the grammaticality of concrete sentences, and sometimes added a better alternative. The interviews were thus a mixture of oral elicitation and free speech, so I received some negative evidence as well. Some gave evaluation numbers from on a scale from 1 (very bad) to 4 (OK) (alternatively: OK, ?, ??, *), while I interpreted their evaluation (and made notes of their ratings) in other cases. I tried to avoid a 5-point scale, fearing that it would be too easy to go for the "undecided" middle point when they were insecure. I wanted an immediate opinion whether a sentence was basically good or bad (cf. 1.4.2).

A concrete problem when evaluating simple VPrt constructions is that the RPrt alternative in most cases is only dispreferred, not outright banned. Hence, some informants will claim both options are equally "good," because neither is ungrammatical. This suggests that Cornips & Poletto's (2005: 252) alternative formulations mentioned in 1.4.2 (asking the speakers to pick the most 'common' alternative in their dialect) are appropriate, not only to avoid prescriptivism but to avoid this problem as well.

In sum, my plan was and still is not to overstate my conclusions from the pilot fieldwork, which was carried out in a quite unsystematic way. However, I feel it is worth mentioning because the answers I got were more interesting than I had expected. They gave

⁶⁵ The younger informants were mainly high school students (aged 16–18), and the older ones mainly pensioners (i.e., older than 65).

clear indications that we must reconsider earlier analyses made for Norwegian VPrt constructions. The results seem quite compatible with the traditional Norwegian dialect literature (from Aasen 1848 to Sandøy 1985), although there has naturally been some development since Aasen's time.

All informants in my pilot fieldwork had a clear preference for LPrt in standard directional VPrt constructions. A couple of the informants did accept RPrt, but only when stressing the direction expressed by the particle. The judgements for unmarked VPrt constructions in *Trøndsk* are roughly as in (18).

- (18) a. **Fosen, Oppdal, Surnadal:** Han kasta {+ut} hunden {-ut}.
b. **Lierne (east):** Han kasta {ut} hunden {*ut}.
He threw {out} the dog {out}
'He threw the dog out'

These results are fully compatible with Aasen's and Sandøy's observations, and with the NDC. However, again it is important to notice that the RPrt representation is possible but generally dispreferred in the South(west) (Oppdal, Surnadal) and on the coast (Fosen). In the East (Lierne), LPrt is more or less obligatory. One young speaker accepted RPrt, while all the older ones discarded it.

2.2 V + LPrt Spelled out with Word Accent

In many Norwegian dialects, V + LPrt is spelled out as a prosodic unit with a single word accent. Western (1921: § 454) notes that this is the pronunciation in East Norwegian dialects, while Sandøy (1976: 13) claims that this is also the standard pronunciation in Romsdal Norwegian and *Trøndsk*. Sandøy (1985: 71) claims it to be the standard pronunciation in East Norway, Trøndelag, Nordmøre, Romsdal, Inner Sogn and to a certain extent in Stavanger as well. Abrahamsen (2003: 197) notes that it can occur in the Sunnmøre dialect (but that it is a new phenomenon), and finally Skaalbones (2006) documents that it is quite common in the Rana dialect. She believes that the East Norwegian intonational pattern has expanded and influenced the West and North Norwegian dialects. Generally, in West and North Norwegian dialects, the spell-out of V + LPrt as a prosodic unit is an alternative, though not standard

(except in Romsdal and a few other places, where it is standard). Traditionally, the particle is prosodically prominent in the north and the west.

When something intervenes between V and Prt, with the exception of a (phonologically reduced) light pronoun or a (light) negation (e.g., *itj* ‘not’), the word accent spell-out is cancelled. This means that V + full DP + RPrT is never spelled out as a prosodic unit. A prominent LPrT is used contrastively in Romsdal Norwegian (Sandøy 1976: 13) (and also in East and Central Norwegian), but is claimed to represent the normal “default” intonation in South and West Norway (Western 1921: § 454). In chapter 4, I will use the word accent spell-out of V + LPrT to distinguish VPrT constructions from ordinary PPs, but I will not discuss intonation *per se*. I urge the reader to consult, e.g., Hosono (2014) for an overview of the intonational properties in Scandinavian VPrT constructions.

There are basically two distinct prosodic realisations of the standard Norwegian VPrT construction. The hyphen in (19a) marks that the relevant words are a prosodic unit, while the capital letters in (19b) mark that the particle is prosodically prominent.

- (19) a. kaste-ut hunden (East Norwegian default)
 b. kaste UT hunden (marked East Norwegian, West Norwegian default)
 ‘throw out the dog’

2.3 Complex VPrT Constructions

2.3.1 VPrT Constructions Followed by a Resultative PP

VPrT constructions followed by a resultative PP are interesting in written Norwegian because the particle distribution is apparently more rigid than in the standard constructions. Again, Hulthén (1948: 168) discusses Mainland Scandinavian data; and while Swedish shows LPrT, Norwegian *Bokmål* apparently only allows RPrT in these constructions like Danish.

- (20) a. **Danish:** Han er i Færd med at bære Sagerne op i Skuret.
 he is in progress with to carry the stuff up in the shed
 ‘He is about to carry the stuff up in the shed’

b. **Swedish:** Han håller på att bära upp grejorna i boden.

he holds on to carry up the stuff in the shed

‘He is about to carry the stuff up in the shed’

c. **Bokmål:** Neste morgen satte Elisas hesten og vognen inn i en låve.

next morning put Elias the horse and the wagon in a barn

‘The next morning, Elias put the horse and the wagon in a barn’

Written Norwegian sources could give us an impression of free alternation in standard constructions as in (1c) and obligatory RPrt in the complex constructions, cf. (20c). However, we have seen that LPrt is strongly preferred in spoken Norwegian, and it is reasonable to consider that there may be preference vs. dispreference in complex constructions too.

Consider (21)–(22) from the Romsdal dialect (Sandøy 1976: 105f). (21) shows two directional constructions in which RPrt is preferred but not obligatory. But in (22), which contains more fixed expressions (not denoting direction), there is more or less free particle alternation:

- (21) a. Han bar {?ut} fangst’n sin {+ut} åt dei fattige.
he carried {out} the catch REFL {out} to the poor
‘He carried his catch out to the poor’
- b. Dei løfta {(?)opp} kassa {+opp} i lastebilen.
they lifted {up} the box {up} in the truck
‘They lifted the box up in the truck’
- (22) a. Han delte {ut} fangst’n sin {ut} åt dei fattige.
he handed {out} the catch REFL {out} to the poor
‘He handed his catch out to the poor’

- b. Han tenkte å legge {ned} noko tå sild'n {ned} på boks.⁶⁶
 he thought to lay {down} some of the herring {down} on can
 'He intended to lay some of the herring down on can'

Recall that in the metaphorical standard (simple) constructions from Romsdal in (4), LPrt is obligatory. This means that the patterns for directional and metaphorical constructions are parallel. There is a similar tendency to have a right-hand particle to a greater extent in both groups when the constructions are augmented with a resultative PP. The LPrt preference in (2) is turned into RPrt preference in (21), and the obligatory LPrt in (4) is turned into free alternation in (22).

We saw in (15) that it is sometimes hard to draw the line between directional and metaphorical constructions, and that some complex constructions that are clearly directional might also have an apparently optional particle distribution (like in the metaphorical constructions in (22)). The picture gets even more confusing when one considers the contradicting claims of den Dikken (1995: 51, 65f) and Svenonius (1996a: 9, 11). Both claim that English and Norwegian are parallel, but Svenonius claims that only RPrt is allowed, and den Dikken argues there is free alternation in both languages. Den Dikken's data are given in (23), Svenonius' in (24). Åfarli (1985: 83) provides a similar example to Svenonius' in (24b), but Åfarli's judgement is similar to den Dikken's (free alternation). In other words, there is no clear consensus concerning these data.

- (23) a. They put {down} the books {down} on the shelves.
 b. They sent {out} a schedule {out} to the stockholders.
 c. Han satte {ned} katten {ned} på gulvet.
 'He put {down} the cat {down} on the floor'
 d. De sendte {ut} møteprogrammet {ut} til aksjonærene.
 'They sent {out} the schedule {out} to the stockholders'

⁶⁶ (22b) can probably be understood as directional, but Sandøy claims that both *dele ut* 'hand out' and *legge ned* 'lay down/conserve' are fixed expressions that have lost a lot of their directional meaning (p. 106). Though (22b) feels more directional than (22a), he is right in the sense that other particles cannot substitute for *ut* 'out' and *ned* 'down' in these expressions. Particle substitution is no problem in (21). Note also that the particle in (21) can be extracted, as in (i), but this is not the case in (22), as in (ii):

- (i) Ut bar han ikkje fangsten
 out carried he not the catch
 'He didn't carry the catch out'
 (ii) *Ut delte han ikkje fangsten.
 *out handed he not the catch
 'He didn't hand out the catch'

- (24) a. The doorman threw {*/OK out} the drunks {out} from the bar.
 b. Vi kastet {*ut} hunden {ut} av huset.
 ‘We threw {out} the dog {out} of the house’

Svenonius rejects the possibility of LPrt whenever it has a complement (DP or PP). The possible LPrt in (24a) (marked with ‘OK’) is facilitated by analysing *from the bar* as an adjunct. When the particle is right-handed, the PP is in other words ambiguous between being construed as an adjunct or as a complement of *out*. Den Dikken’s (1995: 66, footnote 37) Norwegian data in (23c, d) are constructed and judged by only one Norwegian linguist (cf. 1.4.1), but they are strengthened by Áfarli’s (1985) identical judgement.

All in all, directional complex VPrt constructions in Norwegian have a more right-bound particle than the corresponding standard construction. Almost all of the RPrt results that I obtained from NDC searches were from complex constructions. There are also some LPrt variants among the complex constructions, but there is a slight bias toward RPrt constructions.

The distributional patterns exhibited by complex VPrt constructions are shown in (25):

(25) **Complex LPrt and RPrt constructions in the NDC**

| | Dir. LPrt | Metaph. LPrt | Dir. RPrt | Metaph. RPrt |
|--------------------|------------------|---------------------|------------------|---------------------|
| West Norw. | 3 | 2 | 4 | — |
| East Norw. | — | 3 | 4 | — |
| Trøndsk | — | 2 | — | — |
| North Norw. | 2 | 1 | 3 | 4 |
| South Norw. | 1 | 2 | 5 | — |

The total number of results is of course much lower in this table than in table (16). While there was a clear majority of LPrt constructions in (16), there is a slight tendency towards RPrt preference here (20 RPrt constructions vs. 16 LPrt constructions). In line with what we have already seen, metaphorical constructions in most cases have LPrt distribution, and directional constructions usually have RPrt distribution (North Norway being the most obvious exception). A striking result from the searches is that I did not find any RPrt

constructions at all (either standard or complex) in Trøndelag and Nordmøre. The table in (16) revealed that *Trøndsk* is not as well covered as East and North Norwegian, but *zero* is still a remarkable number.

In general, table (16) suggests an obvious pattern, whereas the picture is less clear in the table in (25). The particle distribution is more varied in (25), but it is not totally random; rather, it is quite clear that a resultative PP goes hand in hand with a more right-bound particle. But note that in metaphorical constructions, the particle is still in most cases distributed to the left.

In the pilot fieldwork, I asked about some complex constructions to compare them with the standard constructions. Whereas a slight tendency toward RPrT preference was shown in Oppdal and Surnadal, in Lierne (where LPrT is more or less obligatory in standard directional constructions) the results varied. Some speakers clearly preferred LPrT, others RPrT. Therefore, (26b) does not necessarily indicate free alternation within a single speaker's grammar, but rather varying preference across the speakers.

(26) a. **Oppdal, Surnadal:** Han kasta {-ut} hunden {+ut} i gangen.

b. **Lierne:** Han kasta {ut} hunden {ut} i gangen.

'He threw {out} the dog {out} in the hall'

11 of 18 Oppdal/Surnadal speakers rejected LPrT, 5 found it ok, and 2 were unsure. RPrT was rated with a question mark by 3 speakers, and preferred by the clear majority of 15. This is perhaps also due to the fact that I only asked about directional constructions. As seen above, the metaphorical variants have freer alternation

In section 4.4, I will question the term "complex VPrT constructions." Does the PP have to be resultative, or does adding any kind of PP in the right periphery have an effect? We will then see that the former alternative – a resultative PP – is a prerequisite for the RPrT tendency.

2.3.2 *Constructions with Complex Phrasal Particles*

In addition to simple prepositions, adverbs and adjectives, "short" PPs consisting of a P + a reflexive nominal *seg*, a demonstrative, a personal pronoun, or an indefinite noun may also be

construed as a particle. Since most of these are reflexive, I will refer to them as Pr_{REFL} , although this is somewhat oversimplified.

Hultén (1948: 166f) compares Swedish and Norwegian *Bokmål* data (Danish cannot have the reflexive), and shows that Swedish can only have LP_{REFL} while *Bokmål* allows both Pr_{REFL} distributions. The optionality in Norwegian is also noted by Åfarli (1985: 79), who shows examples with personal pronouns:

- (27) Vi sette {på han} hatten {på han}.
 we put {on him} the hat {on him}
 ‘We put the hat on his head’

Sandøy (1976: 87ff) shows that this kind of construction goes back to Old Norse, in which both LP_{REFL} and RP_{REFL} were possible, cf. (28), though RP_{REFL} is claimed to be statistically preferred. In modern written Icelandic, LP_{REFL} is slightly preferred over RP_{REFL} , and is primarily directional. However, Sandøy’s informants accepted both word orders, cf. (29). Interestingly, they claim that RP_{REFL} constructions emphasise the event (verb) or the direction (particle), while LP_{REFL} constructions stress the DP. This is significantly different from the interpretation of Norwegian LP_{REFL} and RP_{REFL} constructions. Sandøy’s Faroese material shows two Pr_{REFL} occurrences, both of them with right-hand particles. (30) shows one of Sandøy’s examples. His informants have a clear RP_{REFL} preference, which is consistent with the general Faroese RP_{REFL} preference shown in (5b) above. Romsdal Norwegian also follows the standard pattern described above, i.e., LP_{REFL} is preferred, cf. (31). Note also that $\text{V} + \text{LP}_{\text{REFL}}$ is pronounced with a word accent (cf. 2.2). I have added an example from Norwegian TV in (32), where *få-på-plass* (‘get-on-place’) was pronounced as a single word with word accent. Both syntactically and prosodically, Pr_{REFL} thus apparently behaves like an ordinary particle.

- (28) a. **Old Norse, LP_{REFL} :** Eptir þat lagði Haraldr konungr undir sik Sunnmæri
 after that laid Harold the king under REFL Sunnmøre
 ‘After that, King Harold subdued Sunnmøre’
- b. **Old Norse, RP_{REFL} :** Þá lét hann kalla konung til sín ...
 then let he call the king to REFL
 ‘Then he called upon the king’

- (29) **Icelandic:** Svo henti hann {frá sér} hnífnum {frá sér}.
 then threw he {from REFL} the knife {from REFL}
 ‘Then he threw away the knife’
- (30) **Faroese:** So kastar hann {?frá sær} knívin {+frá sær}.
 then throws he {from REFL} the knife {from REFL}
 ‘Then he throws away the knife’
- (31) **Roms No.:** Han kasta {+frå seg} kniven {frå seg}.
 he threw {from REFL} the knife {from REFL}
 ‘He threw the knife away’
- (32) **Grenland, East No.:** Vi må få på plass et annet regelsystem⁶⁷
 we must get on place another rule system
 ‘We have to adapt a new system of rules’

In other words, the system shown in (5) is intact in (28)–(32). There is apparently free variation in Icelandic, RPr_{REFL} preference in Faroese and LPr_{REFL} preference in Romsdal Norwegian. In section 4.4.2, I will discuss these constructions and see whether the reflexive (or short DP) is actually part of the particle, or whether it should be analysed as a particle-external Ground.

2.4 A Second Group of VPrt Constructions

Ven (1999: 47ff) divides Norwegian VPrt constructions into two groups, one of which admits only LPr_t distribution. Group 1 corresponds to the standard directional variants discussed in section 2.1 and in principle allows both LPr_t and RPr_t distribution. Group 2 disallows RPr_t distribution completely and will receive an entirely different meaning if a RPr_t is imposed. Two examples of Group 2 VPrt constructions are given in (33).

⁶⁷ This example was uttered by the politician Bård Hoksrud from Grenland, Telemark, on Norwegian TV 2, April 4th, 2012.

- (33) a. ta {av} bordet {*av}
 take {off} the table {off}
 ‘clear the table’
- b. skrape {av} ruta {*av}
 scrape {off} the windshield {off}
 ‘scrape (something) off the windshield’

Given that the DP has a Ground interpretation (Talmy 1972, 1985, 2010, Svenonius 1996a), these examples are completely impossible with RPrt (cf. section 1.1.2). If the DP has the more marginal Figure interpretation (the table is taken off something else in (33a), and the windshield is scraped off something else, such as a car, in (33b)), then the constructions are of the standard Group 1 type, and particle alternation is possible.

The V + LPrt compound is pronounced as a prosodic unit in the Group 2 constructions as well, in the relevant dialects (see section 2.2). Thus, word accent spell-out gives us an indication that the Group 2 type is also a VPrt construction. Furthermore, there is a clear semantic difference between (34a) and (34b). Only the former example has the V–P word accent spell-out. (34a), which I claim is a Group 2 VPrt construction, means to set the table, while (34b), spelled out in a “standard” verb + preposition manner, means to touch the table.

- (34) a. ta [_{Prt} {på}] bordet {*på}
 take {on} the table {on}
 ‘set the table’
- b. ta [_{PP} {på} bordet] {*på}
 take {on} the table {on}
 ‘touch the table’

In section 5.1, this semantic difference between Group 1 and Group 2, and also the difference between Group 2 and ordinary PPs, will be important when discussing the typology and analysis of VPrt constructions. Despite Ven’s (1999) identification and description of Group 1 vs. Group 2 constructions, they have not been discussed much since.

(34b) can also have a directional interpretation, in addition to locative and iterative ones. Therefore, I will argue that (34a) is not a directional PP, but that Group 2 constructions

should also be classified as VPrt constructions despite their atypical behaviour compared to Group 1.

The standard and complex (Group 1) constructions discussed in 2.1 and 2.3 are relevant when it comes to the alternation problem, but the Group 2 data take the problems one step further. When distinguishing between Group 1 and 2, and between Group 2 and PPs, a new explanandum is introduced: What information is structurally given, and what information is general-conceptual? These questions will be at the forefront of the discussion on chapter 5, and they shed new light on the standard constructions in chapter 4. The classification of the unaccusatives in the next section also contributes to this change of focus.

2.5 Unaccusative VPrt Constructions

There is another VPrt group which resembles Group 2 on the surface, but which is in reality quite different, namely constructions in which the particle combines with an unaccusative verb (cf. Perlmutter 1978, Burzio 1986).

In (35a), V + P is spelled out as a prosodic unit in the relevant dialects (see 2.2), as in the Group 2 construction in (34a). Also parallel to Group 2, the particle selects a Ground DP. The third parallel behaviour between the unaccusative and Group 2 is that they both can form a minimal meaning pair with a “locative” PP, cf. (34b) and (35b). In other words, the similarities in (34)–(35) are striking. In dative dialects, the DP will get dative case in (35b), but accusative in (35a).⁶⁸

- (35) a. gå på toget
go on the train
'enter the train' *or* 'collide with the train'

⁶⁸ Examples like (35a) with accusative case and a corresponding ablative with dative case on the DP, such as *gå tå toja* 'get off the train_{DAT}', are noted from Budal in Sør-Trøndelag (from the NO material). The dialectal preposition *tå* 'off' is a merged variant of *ut av* 'out of' and is a dative preposition, including when used as a particle. This means that movement does not automatically imply accusative case; some prepositions are always associated with the dative.

- b. gå på toget
 walk on the train
 ‘walk (inside the train) during the train trip’⁶⁹

Unlike (34a), (35a) can also have an impersonal variant, and in this case the particle *can* alternate. (36a) makes the unaccusative VPrt construction resemble Group 1 constructions. However, when there is an overt DP complement, the position of *på* must be to the right, cf. (36b).

- (36) a. Det gjekk {på} nokon {på}.
 it went {on} someone {on}
 ‘Someone entered’
- b. Det gjekk {*på} nokon {på} toget.
 there went {on} someone {on} the train
 ‘Someone entered the train’

This puzzle will be discussed more thoroughly in the unaccusative part in section 5.2.

Exploiting data from *Norsk Ordbok* (NO) (see section 1.4.4), I will also show that unaccusative meteorological verbs with a particle are numerous in the dialects. Two examples:

- (37) a. blåse opp
 blow up
 ‘get more windy’
- b. skye på
 cloud on
 ‘get more cloudy’

⁶⁹ In section 5.2, we will see that *på* is not locative or local in a concrete sense, so ‘inside’ would be the wrong grammatical paraphrase. That is an interpretation based on world knowledge rather than a paraphrase of *på*’s semantic content. *På* has a situational rather than a local reading in (35), meaning that it refers to the train trip rather than the physical room inside the train. Cf. also Aa (2013).

The meteorological VPrt constructions also come in personal and impersonal variants. All in all, the unaccusatives are an important part of the Norwegian particle complex, but they have not been discussed much in the literature. Therefore, they are an even more important part of this thesis. Moreover, since they relate to both Group 1 and Group 2 constructions, and to “locative” PPs à la (35b), they are important not only when mapping the Norwegian typology, but also when attempting to determine which differences are purely linguistic and which are not.

2.6 *Med* ‘With’ and Its Role in Complex VPrt constructions

In two of my earlier works (Aa 2004, 2006), which were inspired by observations made by Jespersen (1924, 1940), I discussed the ability of *med* ‘with’ to introduce small clauses with and without relativisation. I argued that *med* can take more complex complements than other prepositions can. Consider the following examples from Aa (2006):

- (38)
- a. ei samling **med** tusenvis av ulike plater (i)
a collection with thousands of different records (in)
‘a collection with thousands of different records in it’

 - b. ei samling **på** tusenvis av ulike plater (*i)
a collection on thousands of different records (in)
‘a collection consisting of thousands of different records’

 - c. ei samling **av** tusenvis av ulike plater (*i)
a collection of thousands of different records (in)
‘a collection consisting of thousands of different records’

Interestingly, when used as a particle, *med* is able to take more complex complements than other particles. Consider the following examples: In (39a), we have a standard *med* construction, and in (39b) a standard *ned* ‘down’ construction. When we combine *med* and *ned*, as in (39c), three different word orders are possible: *med* can precede or follow the DP, and so can *ned*. But (39d) shows an important restriction: *ned* can never precede *med*.

- (39) a. ta med boka
 take with the book
 ‘bring the book’
- b. ta ned boka
 take down the book
 ’bring the book down’
- c. ta med ned boka – ta boka med ned – ta med boka ned
 take with down the book – take the book with down – take with the book down
 ’bring the book down’
- d. *ta ned med boka – *ta boka ned med – *ta ned boka med
 take down with the book – take the book down with – take down the book with
 ’bring the book down’

In chapter 6, we will see that no preposition but *med* has the ability to introduce complex complements as in (38a) and (39c).⁷⁰ Eventually, I will explain this in terms of *med*'s basic semantics of juxtaposing two elements. This means that its grammatical semantics (Bouchard 1995) is crucial for the convergence of the complex structures above. In my earlier work (Aa 2004, 2006, 2008), I did not investigate the preposition with this approach; I analysed it as a prepositional subjunction. But in Anderson's (2010) work on spatial prepositions in the Vestnes dialect of Romsdal, *med* is analysed as a genuine juxtaposer, and this hypothesis is also pursued in my more recent work (Aa 2013, in press). As far as I know, no one has discussed the kind of data in (39c) before. In chapter 6, I will investigate what juxtaposition really means syntactically and semantically, as I will shed new light on *med*'s basic properties. The questions concerning Group 2 and unaccusative constructions will be relevant for this part as well: What part of the semantics is linguistic and what is not?

⁷⁰ *Utan* 'without' can indeed replace *med* and negate (38a), but it cannot replace *med* in (39c).

2.7 Conclusion

From the data introduced in this chapter, it is clear that we need a new starting point for the analysis of Norwegian VPrt constructions. In the dialectological literature, they have been described in a way that has not been taken significantly into account in the linguistic literature (which will become even more clear in chapter 3). Moreover, the NDC gives massive support to the earlier dialectological approaches. In order to move past this impasse, it is necessary to renounce the idea of optional particle distribution; the LPrt alternative is preferred in Norwegian, and these constructions also seem to carry a slightly different meaning as compared to their RPrt counterpart.

In (40), some generalisations from chapter 2 are given. These conclusions will be important as I discuss the earlier theoretical approaches to VPrt in chapter 3 and develop a new analysis in chapters 4–6.

- (40)
- a. LPrt and RPrt are not distributed optionally in Norwegian; LPrt is generally (and by most speakers, *clearly*) preferred.
 - b. The meaning of a given LPrt construction is different from that of the corresponding RPrt construction.
 - c. Metaphorical VPrt constructions are even more LPrt-bound than directional constructions.
 - d. V + LPrt are in many dialects (e.g., in Romsdal, Central and East Norwegian) spelled out as one word/prosodic unit with a single word accent.
 - e. In complex directional VPrt constructions, RPrt is preferred; in complex metaphorical VPrt constructions, LPrt is slightly preferred (but some dialects probably have more or less free variation).
 - f. ‘Short’ PPs (mainly particle + reflexive noun) may be construed as particles prosodically.
 - g. There is a second group of VPrt constructions that does not allow RPrt at all.
 - h. Particles quite frequently combine with unaccusative verbs, and are then obligatorily distributed to the left.
 - i. The preposition *med* ‘with’ is a genuine juxtaposer and can take more complex subject–predicate complements than other prepositions, including when it is acting as a particle.

With (40) in mind, I will propose an analysis of Norwegian VPrt constructions with the hope of accounting for all of these facts (and more). Before this is done in chapter 4, I will evaluate some important previous theoretical accounts in chapter 3, and see whether (and how) they can cope with the data outlined so far. Of course, not all of the theories are primarily occupied with Norwegian, but I have selected works that do include Norwegian in one way or another, either as the primary object of study or in a comparative context.

3 Some Previous Theoretical Accounts

Verb-particle (VPrt) constructions have been discussed thoroughly since the early days of generative grammar, and as we already have seen, as early as the 19th century in more traditional Norwegian approaches. In this chapter, I will focus on some of the earlier generative works that are important for our purposes here, before outlining my own analysis in chapter 4. Some of these works represent theoretical developments that need to be considered in any account of VPrt. My main focus will be on Small Clause (SC) approaches from the 1980s onwards, since this is the traditional theoretical approach to which my own work relates the most directly. However, I will also include one major non-predicational work, namely that of Zeller (2001).

A distinction between predicational and non-predicational approaches is made by Ramchand & Svenonius (2002). They discuss two different theoretical approaches that have developed through the years, namely the SC approach and the complex predicate (CPr) approach. Typically, SC accounts focus on the predication relation between the DP and RPrt in (1a), and (1b) is (in many analyses) seen as a result of movement.

- (1) a. Han kasta [_{SC} hunden ut].
 'He threw the dog out'
 b. Han kasta ut hunden.
 'He threw out the dog'

In SC accounts, the particle is a predicate in a sub-ordinate nexus, and the DP will often (but not necessarily) have the status of a subject in that nexus. In CPr accounts, the adjacency of V + LPrt in (1b) is essential and these two elements are sometimes analysed as a complex verb that must be syntactically or lexically constructed somehow. But as we will see later when considering Zeller's (2001) proposal, the particle might also be analysed as an autonomous lexical complement of the verb.⁷¹

My own analysis in chapter 4 will follow the SC approach, but I will also focus on the problems connected to the CPr accounts by accounting for the V + LPrt adjacency structurally

⁷¹ While Ramchand & Svenonius (2002) operate with the SC vs. CPr classifications, den Dikken's (2002: 146) classification of Zeller (2001) is somewhat different. Zeller is not defined completely in the CPr group here, since he advocates an autonomous (structurally V-adjacent) particle projection.

rather than lexically. Specifically, I will assume that LPrt lexicalises an independent semantic head which is available when a dynamic frame is generated (as opposed to the resultative RPrt frame). Within the SC approaches, the works of Kayne (1985), den Dikken (1995) and Svenonius (1994, 1996a) are important; Svenonius also focuses on Scandinavian data. The CPrt account has earlier origins, dating back to Chomsky (1955). Within this tradition, I will mainly be concerned with Zeller (2001), who presents a thorough discussion and analysis of the syntactic and morphological relations between the verb and the particle.

I will begin by discussing Taraldsen's (1983) and Áfarli's (1985) analyses of Norwegian VPrt constructions as causatives in sections 3.1 and 3.2, respectively. The evaluation of Taraldsen (1983) will be the more elaborate of these two, and I will argue against his assumed Prt–DP base order as well as his empirical claims. In section 3.3 I will turn to den Dikken's (1995) analysis of particles as ergative SC heads, and I will argue against his analysis from a Norwegian perspective. Then, in section 3.4, Svenonius' (1996a) early Minimalist approach adopting EPP-driven particle movement will be discussed. Zeller's (2001) non-predicational approach with the particle being analysed as a lexical V-complement will follow, in section 3.5. Finally, Ramchand & Svenonius (2002) and Ramchand (2008), with their lexical-syntactic approach that takes inspiration from both of the major camps, will be discussed in section 3.6. Here, the particle is assumed to lexicalise the resultative head of a decomposed VP structure. A brief conclusion will be given in 3.7

In section 1.1.1, I mentioned two questions which are highly relevant in this chapter, and which we can paraphrase as follows: *What is the basic word order in a VPrt construction? How are the two alternative word orders in (1) derived?* To provide these questions with well-founded answers, we must also consider the nature of the particle. Is it predicational or not, is it functional or lexical, and is it generated independently of the verb? When discussing the theoretical works below, these questions will be in focus continuously, since they are also highly relevant when trying to map the patterns of particle distribution in spoken Norwegian. A general problem for all the works discussed in this chapter is that they presuppose an optional particle distribution for Norwegian as well as for English. All of these accounts include Norwegian data in their theoretical argumentation in one way or another – either as the primary object of study or in comparison with other Scandinavian languages and/or English.

3.1 Taraldsen (1983): VPrt Constructions as Causatives

3.1.1 Prt–DP Base Order and RPrt Constructions as Causative SCs

Taraldsen (1983) advanced a historically important thesis in the Norwegian generative tradition since this was the first major work to use the early GB framework (Chomsky 1981) to analyse Norwegian data, including VPrt constructions. More specifically, in the particle context, this account also takes advantage of Stowell’s (1981) SC hypothesis, which was newly proposed at the time of Taraldsen’s writing. Taraldsen categorises VPrt constructions as causatives and analyses them on par with *la* ‘let’ causatives like the following:

- (2) Vi lot {løslate} fangene {løslate}
we let {release} the prisoners {release}
‘We released the prisoners’

He advocates a Prt–DP base order and argues using Binding Theory that RPrt constructions are the result of leftward DP movement to a SC subject position, as indicated in (3):⁷²

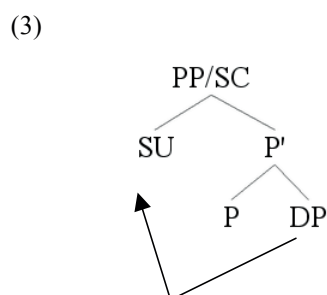

3.1.2 Binding Theory and the Identification of Subjects

Evidence for the SC structure is found in constructions like (4), where it is claimed that the pronoun *oss* ‘us’ must be free in its governing category (GC),⁷³ which is the case only in the

⁷² I will use the DP terminology here and in 3.2, although Taraldsen (1983) and Áfarli (1985) use the NP terminology, since they came prior to Abney’s (1987) DP hypothesis.

⁷³ GC is taken from Chomsky (1981: 209ff) and defined as follows (from Taraldsen 1983: 242): “ α is GC (β) if and only if α is the least constituent γ such that β is governed in γ and γ has a subject.”

RPrT variant. Only the RPrT construction has an intervening subject, *myggen* ‘the mosquitoes’,⁷⁴ between *vi* ‘we’ and *oss*, and hence *oss* is free in its GC there.

- (4) Vi viftet {?*vekk} myggen {vekk} fra oss.
 we waved {away} the mosquitoes {away} from us
 ‘We waved the mosquitoes away’

My first worry about this argumentation is that *oss* could certainly be interpreted as an anaphor rather than a pronoun. The anaphoric interpretation is actually more likely. Note that *myggen*._{3RD PERS. SG.} is not a possible antecedent for *oss*._{1ST PERS. PL.} in any case; the closest matching antecedent for *oss* is *vi*._{1ST PERS. PL.} Furthermore, I disagree with the judgment in (4); in my opinion, the LPrT distribution is equally good. But the judgment in (4) is supposed to give support to RPrT constructions being SCs (unlike LPrT constructions), because the putative pronoun must be free in its GC (unlike an anaphor). Now, I will show that this argumentation generally fails, firstly because the putative pronoun is really an anaphor, secondly because the judgment in (4) is unusual, and thirdly because the theory of anaphor binding was by 1983 not adequately developed for Norwegian. Actually, Hellan (1988) shows that (certain) anaphors can be bound across SC subjects, so that the binding relations are irrelevant for the subject status of *myggen* anyway.

Now, consider (5a), where *seg* is unambiguously an anaphor. I think most people will accept both LPrT and RPrT here. In (5b), I have added an ambiguous example, where particle alternation is also possible.

- (5) a. Han vifta {vekk} myggen {vekk} frå seg.
 he waved {away} the mosquitoes {away} from himself
 ‘He waved the mosquitoes away’
- b. Han vifta {vekk} myggen {vekk} frå plassen sin.
 he waved {away} the mosquitoes {away} from place REFL
 ‘He waved away the mosquitoes from his place’ or ‘from their place’

⁷⁴ Taraldsen paraphrases *myggen*._{DEF.SG} using the plural, which means that it is used as a mass noun.

Following Taraldsen's reasoning, only RPrt should be possible in (5a), because only in that case is the anaphor bound in its GC (i.e., by the SC subject), but as shown by Hellan (1988: 73), anaphors like *seg* 'self' can be bound across intervening SC subjects:

- (6) **Jon** hørte oss snakke om **seg**.
 John heard us talk about SELF
 'John heard that we talked about him'

(6) is one of Hellan's many examples in which *seg* can be bound across the SC by the matrix subject. The examples involving binding of a pronoun vs. an anaphor therefore tell us nothing about the syntactic status of *myggen*, regardless of whether the particle is left- or right-handed. That is to say, *myggen* can be a subject in the LPrt alternative just as it can in the RPrt alternative. Thus, there are three serious objections to Taraldsen's analysis and argumentation: 1) An ambiguous pronoun/anaphor element (*oss* 'us') is unambiguously taken to be a pronoun, 2) the judgment of the data is misleading, and 3) the premises for diagnosing SCs on the basis of anaphor binding are false.

Note also that (5b) is ambiguous as to whether *plassen sin* 'his/their place' refers to the mosquitoes' place or the place of the denotation of the matrix subject. From Taraldsen's reasoning, we should expect LPrt to be the only option in (5b), so that the DP *plassen sin* is free in its GC. An acceptance of RPrt would force an analysis of *sin* in *plassen sin* as an anaphor bound by *myggen*. But I do not think that the particle distribution is decisive for the interpretation of *plassen sin*; instead, both possible particle distributions yield structures that are ambiguous as to the binding relations. That is unexpected given Taraldsen's analysis.

The hypothesis that only RPrt constructions contain a SC structure is nonetheless further supported by (7), according to Taraldsen (1983). PRO subjects in infinitives initiated by the purposive *for å* 'in order to' need to be controlled by a subject from the matrix clause, hence *ulven* 'the wolf' can only function as a subject in the RPrt case in the following example:

- (7) Vi jaget {*ut} ulven {ut} for å PRO gjenfinne sin tapte frihet.
 we chased {out} the wolf {out} to again-find REFL lost freedom
 'We chased out the wolf so that it could get back to its lost freedom'

Since he claims that the DP–Prt order is a result of the DP moving into a SC subject position, the LPrt ban and RPrt convergence follow as natural consequences. The singular form of the antecedent *sin* clearly suggests that the antecedent of the PRO subject must also be a singular noun, excluding the option of *vi* ‘we’. Hence, the only possible solution is that *ulven* is a subject in the RPrt construction, but not in the LPrt construction. In the latter case, the derivation crashes because the anaphor lacks a matching antecedent.

Now, again the premises for diagnosing the SC through anaphor binding are false given Hellan’s (1988) observations, but this example also gives rise to new problems. One problem is that the purpose clause (the infinitive) is inextricably connected to the matrix verb. When PRO is controlled by *vi*.1ST PERS. PL., there is a clear mismatch with PRO’s anaphor *sin*.3RD PERS. SG.. However, I do agree that the RPrt alternative is marginally better, i.e., that the purpose clause is more naturally controlled by *ulven* in that case. It is also easy to paraphrase the RPrt construction with a finite sentence in which the PRO of the purpose clause will refer to *ulven*. (8) illustrates a paraphrase in *Nynorsk*, in which the syntax is closer to colloquial Norwegian.

- (8) *Ulven_i var ute for å PRO_i finne att den tapte fridomen sin.*
 the wolf was out for to find back the lost freedom REFL
 ‘The wolf was outside in order to get back to its lost freedom’

Nevertheless, I maintain that the judgments presented in (7) are too black and white. I would argue that RPrt is *marginally* better,⁷⁵ and that what we rather observe is a *weakening* of the subject status of *ulven* in the LPrt case. *Ulven* shows tendencies to be more “object-like” in the LPrt construction. The PRO subject is therefore more intuitively linked to the matrix subject, hence there is a mismatch between PRO and *sin*. On the other hand, PRO is easier to interpret as being controlled by *ulven* when it is a “real” SC subject, i.e., in the RPrt alternative. That is probably why RPrt is slightly better than LPrt in (7). But even with RPrt, the sentence is not perfect – and it is not ungrammatical with LPrt, as claimed by Taraldsen. We will return to the weakening of the predication relation between LPrt and the DP compared to the DP–RPrt relation in chapter 4. It is important to stress that we are discussing tendencies, and not clear boundaries – a weakening, not a complete loss.

⁷⁵ This is my own judgement. I asked three randomly picked informants for their judgement, but all of them found (7) quite confusing and hard to judge, both with LPrt and RPrt distribution, and I assume this has to do with the mentioned problem that the purpose clause is inextricably connected to the matrix verb. That makes neither of the alternatives sound natural.

3.1.3 Reanalysis, the Status of P, and Case Assignment

Taraldsen's next step is to exploit the parallelism between prepositions and particles; he categorises both as P. In VPrt constructions, the DP is generated as a complement of P in this analysis, and it is allowed to shift to Spec,PP (the SC subject position). This movement is the most minimal and straightforward way to analyse the VPrt alternation within the X-bar-scheme, as illustrated in (3). However, the DP complement of an ordinary preposition cannot shift like the DP in a VPrt construction:

- (9) a. *Vi lekte en flaske vin med
 we played a bottle wine with
 'We played with a bottle of wine'

b. *Vi lekte ...

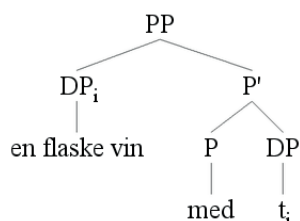

This construction is assumed to crash because the A-chain created by movement of the DP is assigned two theta-roles: one from P to the trace, and one from P' to the SC subject. The reason why the similar example in (10) is possible, according to Taraldsen, is that P' undergoes reanalysis, which exempts it from assigning a theta-role to its subject. The reanalysis allows (but does not force) the DP to move to spec,PP and gives the construction a causative reading; thus, a complex predicate is formed. This could suggest that the DP movement is in a way triggered for predication reasons (cf. 3.1.2), since only RPrt constructions are SCs in Taraldsen's analysis.

- (10) Vi tok [PP [en flaske vin]_i [P' med t_i]].
 we took a bottle wine with
 'We brought a bottle of wine'

The reanalysis also exempts P from being a Case assigner. The shifted DP receives Case from the verb, and the DP chain gets its theta-role from the complex predicate kernel (V + P).

In the LPrT version in (11a), the DP still receives its theta-role from the reanalysed complex predicate kernel. *Tok* is the Case assigner which c-commands the DP (*med* ‘with’ is just a possible Case assigner). The particle and the DP thus cannot undergo wh-movement as a complex in (10b) (because the particle lacks Case assigning abilities). Here, *hva slags flaske vin* ‘what kind of bottle of wine’ fails to receive Case, because it is not c-commanded by its assigner (*tok* ‘took’).

- (11) a. Vi tok med en flaske vin.
we took with a bottle wine
‘We brought a bottle of wine’
- b. *[Med hva slags flaske vin]_i tok dere t_i?
with what kind bottle wine took you
‘What kind of bottle of wine did you bring?’

The lack of reanalysis explains why the prepositional construction (12) is OK, contrary to (11b), though *med* is still a Case assigner in (12), and c-commands the wh-moved *hva slags flaske vin* (cf. Taraldsen 1983: 248).

- (12) [_{PP} Med hva slags flaske vin]_i lekte dere t_i?
with what kind bottle wine played you
‘With what kind of bottle of wine did you play?’

Now, there is an important detail to note concerning the LPrT construction in (11a). Although *tok* is assumed to be the Case assigner, the convergence presupposes that *med* ‘with’ is a possible Case assigner. In his comparison with *la* ‘let’ causatives, Taraldsen shows some examples where the *in situ* DP is assigned Case (13a) and others where it is not (13b); cf. the discussion on Taraldsen’s pp. 212f.

- (13) a. Vi lot løslate fangene.
we let release the prisoners
‘We released the prisoners’

- b. *Vi lot bli løslatt fangene.
 we let get released the prisoners
 ‘We got released the prisoners’

In both of these examples, reanalysis has applied and the constructions receive causative readings; the embedded verb is not an actual Case assigner in either of the examples. Instead, Case is assigned by the matrix verb *lot* ‘let.’ However, the two examples differ with respect to the main verb being active in (13a) vs. passive in (13b). Only the former of these is a possible Case assigner, which leads Taraldsen to the following generalisation: “A NP in the embedded VP in the causative construction is Case-marked only if both the matrix V la and the infinitive are Case-assigners” (pp. 212f). Since VPrt constructions are also causatives, this predicts that a particle must be a possible Case assigner as well, in order to “transfer” Case to the *in situ* NP in LPrt constructions. In 3.2, we will consider some of Áfarli’s (1985) remarks against this prediction. Note also that in Taraldsen’s analysis (13a) is not a SC; the DP must shift to the subject position in order to create a predication relation.

However, expletive insertion in (14a, b) challenges his analysis seriously:

- (14) a. Vi lot det løslate fanger.
 we let it release prisoners
 ‘We released prisoners’
- b. Vi lot det bli løslatt fanger.
 we let it be released prisoners
 ‘We released prisoners’

First, the expletive insertion shows clearly that *det løslate fanger* ‘it release prisoners’ is predicative, i.e., with the inf–DP order. Second, there is a problem with Case assignment. Given Taraldsen’s analysis, *lot* must assign Case to *det* ‘it’ and also to *fanger* ‘prisoners’ via *løslate* ‘release’ in (14a). Note also that (14b), unlike (13b), is grammatical. But the mechanism that Taraldsen uses to assign Case to the *in situ* DP is impossible in (14b), because the passive *løslatt* ‘released_{PASS}’ is not a possible Case assigner in his analysis. The convergence of (14b) is thus unexplained.

In general, I find the systematic comparison between VPrt constructions and *la* causatives (cf. Taraldsen's section 4.2.3) somewhat problematic, since the latter group is not productive in spoken Norwegian. An exception is the reflexive variant *Hun lot seg overtale* she let REFL persuade 'She was persuaded' (Taraldsen's p. 231) (cf. 1.1.3, footnote 10). The DP-V variant *Vi lot fangene løslate* we let the prisoners release 'We released the prisoners' (Taraldsen's p. 218) is not productive at all. I will therefore not discuss this issue further.

On his p. 250, Taraldsen shows an interesting minimal pair with respect to the acceptability of topicalisation:

- (15) a. Ut slipper vi ikke den hunden.
 out let we not that dog
 'We will not let that dog out'
- b. *Ut den hunden slipper vi ikke.
 out that dog let we not
 'We will not let that dog out'

Given Taraldsen's basic analysis of VPrt constructions, cf. (3), *ut den hunden* 'out that dog' forms a constituent and should yield a grammatical result. However, since reanalysis deprives *ut* 'out' of its Case-assigning capacity, *den hunden* 'that dog' fails to receive its Case in (15b). In other words, (15b) fails for the same reason as (11b), cf. Taraldsen's discussion on his pp. 249–50. However, given this analysis, the convergence of (15a) is a mystery. In (16), Taraldsen's basic representation is *ut* + DP_R.

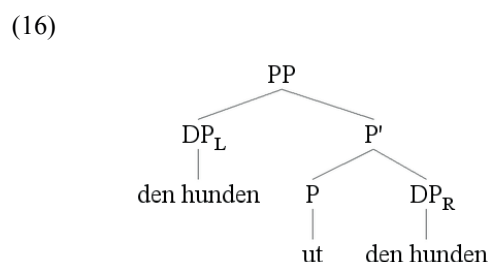

When *ut* + DP_R form a constituent, Taraldsen's analysis depends on reanalysis (for the Case reasons mentioned above). But how can *ut* be topicalised without *den hunden* and still yield a grammatical result? A head cannot be topicalised, so instead we would have to account for

movement of the DP followed by A' movement of P', i.e., *ut* + the trace of the DP. In other words, Taraldsen needs an extra device (reanalysis) to account for the failure of (15b), and he needs a dubious *ad hoc* solution in order to make (15a) converge. In standard GB theory, this was a rather unusual operation, but since Kayne (1994), *remnant movement* has been widely accepted. This means it is permitted to move a constituent from which one part has already been extracted. The problem with remnant movement is that a constituent involving a trace moves to a position where the trace is no longer c-commanded by an antecedent. In a derivational analysis one could assume that the trace is correctly c-commanded before the remnant movement and this suffices to avoid a crash.⁷⁶

Note that if we assume $DP_L + ut$ to be the basic order in (16), the analyses of (15) are much simpler. (15b) fails naturally because we have topicalised a non-constituent, and (15a) converges since it can be considered standard A' movement of P' – given that we accept A' movement of a bar-level projection.⁷⁷ We will see in chapter 4 that we must generally allow for topicalisation of the particle in directional (predicative) constructions, while it is not possible in metaphorical (idiomatic) constructions. I will assume that the simpler analysis, assuming $DP + ut$ as the basic order, is the correct one.

Also, if we extend (15a) to a complex VPrt construction, as in (17), the topicalisation is explained with $DP_L\text{--}Prt\text{--}PP$ as the basic order.

- (17) [Ut i hagen]_i slipper vi ikke den hunden t_i.
 out in the garden let we not that dog
 'We will not let that dog out in the garden'

With the PP *i hagen* 'in the garden' analysed as the complement of the particle, we have topicalised a constituent. But given Taraldsen's basic order, $Prt\text{--}DP_R\text{--}PP$, the topicalised element is not a constituent, and (17) should crash.

Finally, I will mention an argument against Taraldsen's (1983: 247f) distinction between a particle (18a) and a preposition (18b) in the following pair:

⁷⁶ See discussions on remnant movement by den Besten & Webelhuth (1990) and Stabler (1999).

⁷⁷ Note that if we accept Bare Phrase Structure (BPS) (cf. section 1.2.1), (15a) implies a topicalisation of a full phrase, since bar levels do not exist in BPS. (15a) can therefore be taken in favour of BPS contra X-bar theory.

- (18) a. Det ble tatt {*med} vinflasken {*med}.
 it was taken {with} the wine bottle {with}
 ‘The wine bottle was brought’
- b. Det ble lekt med vinflasken.
 it was played with the wine bottle
 ‘There was played with the wine bottle’

In Taraldsen’s analysis, the crash in (18a) is due to the reanalysis, which deprives *med* ‘with’ of its ability to assign Case. The DP is not thematically linked to *med*, as it is in (18b); in (18a), it is linked to the complex *ta med*. However, there is reason to believe that (18a) actually fails because of the indefiniteness effect, which affects (SC) subjects and objects – but not P-complements – in impersonal constructions. (18a) converges perfectly with an indefinite DP (independently of the particle position), cf. (19a). The effect is the same in the unaccusative VPrt construction in (19b).

- (19) a. Det ble tatt {med} en vinflaske {med}.
 it was taken {with} a wine bottle {with}
 ‘There was brought a wine bottle’
- b. Det gjekk {på} ein mann/*mannen {på}.
 it walked {on} a man/the man {on}
 ‘There went a man/the man on’

(18a) and (19a) indicate that the DP is a subject independently of the particle position – i.e., that the DP position is constant, and that the alternation is due to particle movement rather than DP movement. Hence, the terms LPrt and RPrt are more suitable than DP_L and DP_R to describe the situation in (16).

3.1.4 Conclusion

Taraldsen (1983) was the first to analyse Norwegian VPrt constructions assuming a SC approach (Stowell 1981). At least one aspect of Taraldsen’s analysis is attractive, namely the claim that the two alternative word orders in VPrt constructions differ with regard to

predication. In such an approach, DP–Prt order is the result of the DP moving into the spec,PP position, i.e., the SC subject position, and is thus the only predicative construction of the two.

Despite the appeal of this analysis, I do not agree with some of the crucial data that are taken to motivate it. I think that Taraldsen’s judgments are generally too categorical, and that the Prt–DP (LPrt) constructions show a weakening of the subject status of the DP. The binding data in 3.1.2, which are taken to motivate the subject status of the left-handed DP contra the non-subject status of the right-handed DP, are also misleading. Again, the judgments are too categorical here, and it is evident that Taraldsen’s work was done before the theory of Norwegian anaphors was adequately developed. Hellan’s (1988: 73) observation that certain anaphors can be bound across an intervening subject thus represents a crucial objection to Taraldsen’s recognition of SC subjects. Furthermore, we have seen that the basic Prt–DP order causes several problems. Assuming that DP–Prt is the base order explains the pattern of topicalisation in (15) more elegantly (i.e., the particle and the DP do not form a constituent and cannot be topicalised together), and some of the data rather indicate a constant DP (subject) position with a particle that can move across it.

We have seen above that reanalysis deprives the particle and the embedded verb in *la* causatives of their Case-assigning property, but that the particle and embedded verb must still be possible Case assigners if the *in situ* DP is to receive Case. However, this yields the wrong predictions for *la* causatives, and it also wrongly predicts that all particles must be possible Case assigners, i.e., prepositions. This would exclude the attested adjectival particles and adverbial particles (Toivonen 2002: 192ff). In the next section, we will see that this is one of Åfarli’s (1985) objections to Taraldsen’s (1983) analysis, and we will confirm that a lot of the empirical challenges seen in this section are overcome if we assume a DP–Prt base word order.

3.2 Åfarli (1985): Causatives with a DP–Prt Base Order

3.2.1 The Basic Order and the Critique of Taraldsen (1983)

A problem with Taraldsen’s (1983) analysis is that it only deals with prepositional particles and their parallelism to ordinary (non-reanalysed) prepositions. Åfarli (1985) provides a number of examples with non-prepositional particles. The examples in (20) are taken from his

p. 79, and illustrate the particle use of full PPs (a) (see sections 2.3.2 and 4.4.2), adverbs⁷⁸ (b) and adjectives (c, d). As discussed in the previous section, Taraldsen (1983: 212f) suggests that the DP in the embedded VP of a *la* ‘let’ causative is only Case marked if both the matrix V (*la*) and the infinitive are Case assigners, so a passive infinitive is excluded.⁷⁹ A passive is not a Case assigner and cannot “transfer” Case from the matrix V. For the same reason, the LPrt versions of the causatives in (20) are predicted to be ungrammatical in Taraldsen’s system, since none of the particles in these examples are possible Case assigners. However, they are all frequently used with LPrt in Norwegian except (20d), which is taken from Åfarli’s Halså dialect (western *Trøndsk*), in which there are restrictions on LPrt distribution.

- (20)
- a. Vi tok {av oss} jakkene {av oss}.
we took {off us} the jackets {off us}
‘We took the jackets off’
 - b. Vi fulgte {heim} Petter {heim}.
we followed {home} Petter {home}
‘We followed Petter home’
 - c. Vi gjorde {klar} bilen {klar}.
we made {ready} the car {ready}
‘We prepared the car’
 - d. Vi måla {blå} bilen {blå}.
we painted {blue} the car {blue}
‘We painted the car blue’

Åfarli points out several problems with Taraldsen’s analysis (e.g., the tests of constituency in (15), cf. Åfarli’s p. 81), and he suggests that positing a DP–Prt base order can alleviate some of these problems. For Åfarli, LPrt constructions are a result of particle movement to the left, as suggested in (21c).

⁷⁸ In more modern terms, *heim* ‘home’ is also categorised as a preposition (cf. Faarlund et al. 1997: 414).

⁷⁹ Cf. the following *Bokmål* example:

- (i) *Vi lot bli løslatt fangene.
we let be released the prisoners
‘We let the prisoners be released’

- (21) a. Jon sparka hunden ut
'John kicked the dog out'
b. Jon mála bilen blá
'John painted the car blue'
c. Jon ...

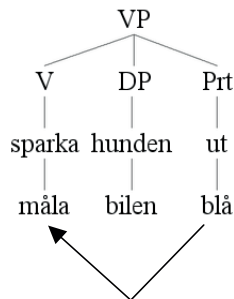

Note that Áfarli (1985) uses a flat structure, but he posits a semantic SC, so the analysis is easy to translate into structural SC terms.

Another argument for suggesting DP–Prt as the base order is that Prt–DP always seems to have a corresponding DP–Prt alternative, but not vice versa. In more general terms, the predicate phrase (PRED) (= Prt in (21)) in a causative always has the option of being positioned to the right of the DP, but not all PREDs may shift to the left. In 5.1, we will see that English and Faroese adjectival particles are right-bound, while (some) Norwegian and Icelandic adjectives may shift.

Moreover, and more importantly, only right-hand particles can be modified by degree elements:

- (22) a. Jon sparka hunden rett ut.
John kicked the dog right out
b. *Jon sparka rett ut hunden.
John kicked right out the dog
'John kicked the dog right out'

In Taraldsen's (1983) analysis, (22b) is predicted to be grammatical, since the adverb/degree element should not change the status of *ut* 'out' as a possible Case assigner. That is, although it ceases to be a Case assigner through reanalysis, Taraldsen's analysis presupposes a possible

governor for the *in situ* DP. In Áfarli's analysis, the PRED *rett ut* 'right out' is too complex to move as a unit, which causes (22b) to crash (in section 3.6.4, we will see that we can formulate this in general terms concerning restrictions on head movement).

3.2.2 VPrt Constructions as Causatives

Like Taraldsen, Áfarli situates VPrt constructions within a broader class of causatives, but he assumes a different basic order, namely S V O PRED:

Here S is the causer, O the causee, and PRED is predicated about O, the causee. Causatives always involve predication in the sense that something must be analysable as predicated about the causee, i.e. the person or thing that is affected by the action brought about by the causer (Áfarli 1985: 85).

We can also consider one of his examples from p. 76 in light of this quote, cf. (23):

- (23) Jon drakk kaffen varm.
John drank the coffee warm
'John drank the coffee while it was warm', *or*
'John drank so (fast) that the coffee got warm'

The most (and perhaps only) plausible interpretation of this example is that the coffee was warm while John was drinking it, i.e., a non-causative interpretation. (A causative interpretation would be that the coffee got warm as a result of John's drinking it.) As shown in (21), Áfarli assumes a flat structure and uses Taraldsen's reanalysis device to explain the structural difference between the two interpretations (in the causative, V and PRED are reanalysed as one complex predicate-kernel, cf. p. 76). Thus, the reanalysis of V + PRED/Prt as a complex predicate kernel is responsible for the causative interpretation of the structure. Also, the reanalysis licenses particle movement of PRED to the left, given that PRED is sufficiently simple, in Áfarli's terms.

Note also that the particle movement in (21) does not leave a trace. This stipulation can explain the non-convergence of (24):

- (24) *Vi sparka ut hunden ___ huset.
we kicked out the dog ___ the house
'We kicked out the dog from the house'

If we assume that the moved particle does not leave a trace in its base position, it is clear that *huset* ‘the house’ lacks a Case assigner. Analyses which presuppose leftward particle movement as ordinary head movement need another device to explain why (24) fails.⁸⁰

On his p. 81, Áfarli explicitly defends a flat structure for the causatives. The reason for his insistence on this point is that the DP and the particle do not form a constituent and cannot be topicalised:

- (25) *Hunden ut sparka við.
 the dog out kicked we
 ‘We kicked the dog out’

In chapter 4, we will return to these problems and try to solve them assuming a binary structure. The failed topicalisation of a non-constituent in (25) can e.g. be explained if we assume that the SC subject is based in a functional projection above the PP (cf. Bowers 1993).

3.2.3 *The Predicational Nature of VPrt Constructions*

Although the flat structure in (21) does not assume the causee (O) to be a structural subject, it is clear from the article in general that Áfarli assumes a semantic SC analysis of the VPrt construction. On his p. 85, he discusses the predicational nature of the structure in light of Hellan’s (1982) observations of *seg*-reflexives. These must be bound by an antecedent, which takes the expression that contains the reflexive as its predicate. Thus, the following grammatical constructions suggest that there is a predication relation between the antecedent (= the causee) and the phrase that contains the anaphor *sin/sitt* ‘itself’:

- (26) a. Vi mála bílini blá på taket sitt.
 we painted the car blue on the roof itself
 ‘We painted the car blue on the roof’

⁸⁰ I will return to this problem in 5.1.1 and suggest that movement analyses must generally assume that a preposition, unlike a verb, cannot license a DP from its trace.

b. Vi skrudde hjulet_i på på akslingen sin_i.
 we screwed the wheel on on the shaft itself
 ‘We screwed the wheel on the shaft’

Åfarli notes explicitly that *blå på taket sitt* ‘blue on the (its) roof’ and *på på akslingen sin* ‘on the (its) shaft’ must be construed as predicates with the two causees, *bilen* ‘the car’ and *hjulet* ‘the wheel’, as their respective subjects. This is also parallel to the claim that *ut* ‘out’ and *blå* ‘blue’ are predicates in (21). On his p. 86, Åfarli continues his argumentation by showing that the relevant parts of the structures in (26) can also be paraphrased with finite copula constructions: *Bilen_i vart/er blå på taket sitt_i* ‘the car became/is blue on the (its) roof’. In sum, this means that Åfarli (1985) anticipates the type of structural SC analyses later developed by, e.g., Svenonius (1994, 1996a) (see 3.4).

Åfarli (1985: 86) claims that the particle position does not affect its status as a predicate, and also the interpretations of the reflexives are constant (cf. *Han skrudde på hjulet_i på akslingen sin_i* ‘he screwed on the wheel on the (its) shaft’, which is not only possible, but the preferred alternative for most). This is contrary to Taraldsen (1983), who posits a SC structure only in the DP–Prt cases, where the DP has moved into the subject position. However, we saw in 3.1.2 that his judgements were too categorical, and also that the binding theory of Norwegian anaphors were not adequately developed at the time.

Note that assuming particle movement to account for the alternation implies a predicational structure in both cases, because the (subject) DP position is constant (cf. 3.1.3). Assuming DP movement into a subject position to account for the alternation implies different semantic interpretations, i.e., \pm predication. There is, however, also an in-between option here. One could argue that the alternation is covered by particle movement, with the effect of weakening the predication. This better explains the status of Taraldsen’s binding examples discussed in the previous section. In chapter 4, I will propose a system that gives rise to different semantic tendencies between the two particle orders, and I will maintain Åfarli’s claim that both structures are basically predicational. At the same time, I will follow Taraldsen in drawing a semantic distinction between the two structures. Still, my approach lies closer both theoretically and empirically to Åfarli (1985) than Taraldsen (1983).

3.2.4 Conclusion: Ignoring the Dialectology

Taraldsen (1983) and Åfarli (1985) have both made important contributions to the study of Norwegian VPrt in a generative linguistic framework. Both capture essential parts of the semantics of the construction by classifying it as a causative structure. Taraldsen's analysis takes advantage of Stowell's (1981, 1983) observations and analyses the "causee" DP as the structural subject in a particle SC (but only in RPrt constructions). Taraldsen and Åfarli argue for different basic VPrt structures, and derive the alternative word orders in different manners. It is quite evident that Taraldsen's Prt–DP base order causes many problems. Structures judged as unacceptable are predicted to converge, while structures judged as acceptable are predicted not to converge. Åfarli's objections are crucial to resolving this situation, since the empirical coverage is improved when one assumes DP–Prt base order.

Although Åfarli uses data from his own Halså dialect, it is a weakness of both his and Taraldsen's analysis that they do not look to the Norwegian dialectological literature for empirical support. In Aasen's (1848, 1864) work, it is quite evident that LPrt is generally preferred in Norwegian, and that a given LPrt construction differs in meaning from the corresponding RPrt construction. Furthermore, Sandøy (1976) provides a number of interesting details from the Romsdal dialect, both concerning the alternation problem and the difference between directional and metaphorical constructions. Unfortunately, Aasen's and Sandøy's empirical observations are not reflected in Taraldsen's and Åfarli's analyses. Instead, they assume optional word order in the standard VPrt construction. Since the emergence of Minimalism in the early 1990s, principles of economy have made optional derivations impossible; hence, a free particle alternation is a real theoretical challenge. In Den Dikken's (1995) analysis of particles as ergative SC heads, a solution to this and many other problems is proposed. Some of his ideas are presented and discussed in the next section.

3.3 Den Dikken (1995): The Particle as an Ergative Head of the SC

3.3.1 The Basic Structure and Derivations

Den Dikken's (1995) book-length work presents a thorough and important analysis of VPrt in the generative tradition. His basic idea is to renounce the analysis of particles as intransitive prepositions (contra, e.g., Emonds 1976), and instead introduce particles as *ergative SC heads* (his p. 35). He is primarily occupied with complex VPrt constructions, which I will discuss in

3.3.2, but he also applies his analysis to the simplex constructions (= the standard construction) (my 3.3.3, his p. 86ff). The basic word order in his analysis is Prt–NP,⁸¹ and RPrT constructions are derived by a leftward NP movement into the subject position of the ergative particle-headed SC. In LPrT constructions, the NP stays *in situ* and the particle undergoes abstract incorporation (reanalysis) into V:

- (27) a. They looked {up} the information {up}.
 b. They [_v looked]

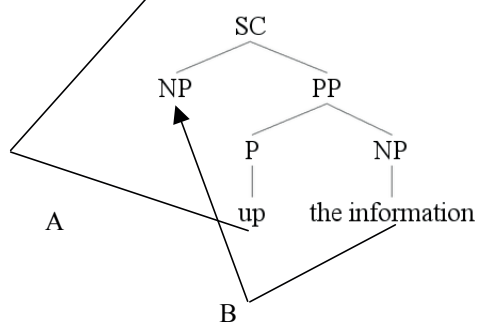

- A: Operation for LPrT constructions: Abstract particle incorporation into V.
 B: Operation for RPrT constructions: NP movement into Spec,SC.

The analysis depicted in (27) is similar to Taraldsen's (1983) proposal outlined in section 3.1, with NP movement into a subject position, but the technical details are quite different. The most important difference is perhaps that den Dikken's LPrT constructions are derived by a sort of movement as well, namely the abstract incorporation of the particle into V (after Baker 1988). We will see that he tries to cope with the problem of optional movement by proposing that particle verbs can select SCs with or without a functional projection (FP). The absence of a FP forces the particle to incorporate into V, and the NP gets Case *in situ* (see 3.3.2), while the presence of a FP blocks the incorporation and instead forces the NP to move to a higher position in order to get Case, resulting in a RPrT construction. The details of these operations and how the analysis escapes the optionality problem are discussed in 3.3.2.

I will postpone the discussion of den Dikken's analysis of the simplex constructions to 3.3.3, because the details of the analysis must be understood in the light of the analysis of the complex constructions, outlined in 3.3.2. In 3.3.4, I will discuss the claimed ergative nature of

⁸¹ Since the lexical categories are crucial in den Dikken's analysis, I will refer to the nominal phrases as NPs here in 3.3, following den Dikken's own notation.

particles, which is a crucial detail that purportedly enables Prt–NP base order. However, we will see that the Norwegian data (including the data presented by den Dikken himself) do not support this proposal. Finally, I discuss particle modification in 3.3.5 and conclude the discussion of den Dikken (1995) in 3.3.6.

3.3.2 Complex Constructions and the LPrt/RPrt Alternation

Den Dikken is primarily occupied with complex constructions of the type in (28), which is represented with a double SC structure:

- (28) a. They made {*?out} John {out} a liar.⁸²
 b. [IP They [VP made [SC1 [Spec_{ec} ec] [PP out [SC2 John a liar]]]]]

The particle *out* is analysed as an ergative head of SC1, meaning that it is not a Case assigner and hence that *John* cannot receive Case in its base position in Spec,SC2. Instead, *John* must move to the theta'-subject position in SC1, headed by the particle, so it can receive Case from V:

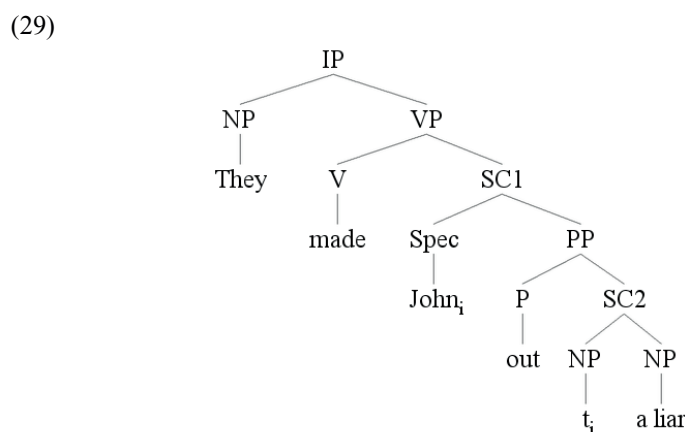

Importantly, den Dikken makes the empirical observation that LPrt is impossible in (29). Rather, a left-hand particle seems to combine better with a *prepositional* complex particle construction, cf. (30a). The sentences containing a complex *nominal* particle construction

⁸² Bridget Samuels (p.c.) notes the following concerning this example: “For what it’s worth, I think the example in (28a)/(30b) is quite bad with either word order. I can only say *They made {John} out {?John} to be a liar.*”

(30b = 29) and a complex *adjectival* particle construction, (30c), only converge with a right-hand particle (examples from den Dikken's pp. 55f). I have put the curly brackets around the nominals in (30) to highlight their connection with the structure in (29).

- (30) a. They put {the box} down {(?)the box} on the shelf.
 b. They made {John} out {*?John} a liar.
 c. They painted {the barn} up {*?the barn} red.

All of these examples converge with the particle to the right of the nominal, but LPrT works much better in (30a) than in (30b, c). Now, if we try to analyse these sentences in the frame of (29), we notice that there is a crucial difference with respect to categories. (30a), corresponding to (31a), contains two categorically identical SCs, namely two PPs. In contrast, (30b), corresponding to (31b), and (30c), corresponding to (31c), have SCs from two different categories. (31b) features a PP (SC1) + a NP (SC2), and (31c) features a PP (SC1) + an AP (SC2).

- (31) a. They put [_{SC1} PP {the box} down [_{SC2} PP {(?)the box} on the shelf]].
 b. They made [_{SC1} PP {John} out [_{SC2} NP {*?John} a liar]].
 c. They painted [_{SC1} PP {the barn} up [_{SC2} AP {*?the barn} red]].

Since Case is assigned by V and not by the ergative particle, SC2 is a barrier for government, and the SC2 subject in (31b, c) is therefore forced to move for Case reasons, cf. the structure in (29). In (31a), the apparently optional NP movement indicates that SC2 is not a barrier in this case – and that is exactly den Dikken's point. Since the particle is categorised as P, the predicate of SC2 in (31a) is categorically identical to the predicate of SC1, while the corresponding predicates are categorically distinct in (31b, c). This makes the lower PP in (31a) a segment of the entire multi-segment PP (cf. Chomsky 1986: 7, 76),⁸³ and hence L-marking from V percolates to the bottom of the lower segment. This in turn allows V to assign Case to the SC2 subject.

⁸³ If A is adjoined to the category B, then A is not dominated by B, but they are two segments of the same category (cf. Chomsky 1986: 7). If we assume that the SC1 PP in (31a) is generated through adjunction to the SC2 PP, then both of the PPs are segments of the same category (i.e., a multi-segment PP). V's L-marking of the SC1 PP then percolates to the head of the SC2 PP, since they are technically the same category (den Dikken 1995: 58).

In LPrt constructions, the particle potentially intervenes in V's government of the NP. Chomsky's (1986: 10, 42) Minimality Condition excludes V's government of the SC2 subject in (31a) if there is a "closer governor" to the NP. The particle is an intervening closer governor in this case, but the problem can be avoided, according to den Dikken, by reanalysing the particle together with the verb. This reanalysis takes the form of abstract particle incorporation into V, and differs from Taraldsen's (1983) reanalysis discussed in 3.1. By adopting Baker's (1988) (abstract) head incorporation and the Government Transparency Corollary (GTC), Case is assigned "naturally" to the SC2 subject. The GTC says that a lexical category (V) with an incorporated item (the particle) governs everything that the incorporated item governed in its original position. SC2 is then exempt from being a barrier of government, so the SC2 subject is governed by the reanalysed V–Prt complex. Again, this is only possible with categorical identity between SC1 and SC2.

Principles of economy prevent the NP from moving to SC1 without a reason; if it gets Case *in situ*, it stays *in situ*. Since both word orders are possible in constructions like (31a), we must expect one operation to exclude the other. That is, reanalysis makes NP movement unnecessary and hence impossible. Without reanalysis, NP movement is obligatory. A set of questions immediately arises: when/why does reanalysis occur, and when/why does NP movement occur? The surface location of the particle seems to be optional. If NP movement were more economical than reanalysis, RPrt order would be obligatory, while LPrt would be obligatory if reanalysis were more economical. Den Dikken suggests on p. 27 that particle verbs might select SCs with or without a functional projection (FP). The presence of a FP makes particle incorporation impossible, following Li's (1990) definition of improper movement, which bans an A-head (lexical head) from crossing an A'-head (functional head) to another A-head (in this case, V) (cf. den Dikken's p. 17). Such movement would violate Principle C of the extended Binding Theory. Li's principle also correctly predicts that abstract incorporation typically does not contain functional (inflectional) material.

When no FP intervenes, particle movement and incorporation are possible and hence obligatory. The surface locations of the NP and the particle thus depend on whether the SC structure contains a FP or not. Both LPrt and RPrt constructions thereby follow principles of economy. Den Dikken (2002: 167) stresses this point, suggesting that "the syntax is free to generate a functional projection on top of the projection of the particle or not to do so." If we extend (29) with a FP above SC1, particle incorporation into V is barred by the functional category F:

(32)

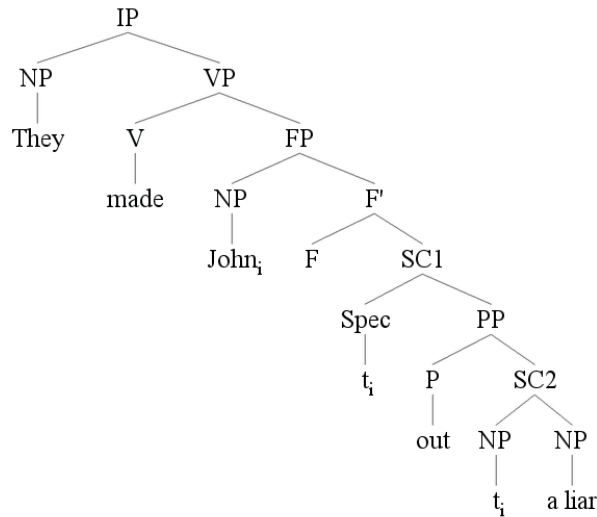

In sum, particle movement/incorporation is motivated for Case reasons, but it remains unclear when and why a FP is generated. Postulating the ability of the syntax to generate a FP is a stipulation, not an explanation. The alternation problem is simply moved to another domain and remains unexplained. The question of whether the particle (or the NP) moves or not is replaced by the question of whether the syntax generates a FP or not. But the question of *why* the syntax would (or would not) generate a FP remains open. It is of course possible that the English particle alternation is simply an outcome of this available syntactic operation, in which case the alternation is arbitrary in syntactic (and semantic) terms and needs to be explained in some other domain.

3.3.3 *Simplex Constructions*

As mentioned above, den Dikken's strategy seems to be to try to explain complex and even marginal VPrt constructions to begin with, and then to transfer the analysis thus developed to cover simpler and more common VPrt constructions. This is quite an unusual strategy to my knowledge (probably inspired by Kayne 1985), but still effectual. Den Dikken's example of a simplex or standard particle construction is given in (33) (cf. also the simplified tree structure in (27)):

- (33) They looked {up} the information {up}.

First of all, den Dikken (following Svenonius 1992) rejects Kayne's (1985) proposal to derive LPrT constructions from right-adjunction of an NP. The following examples in which an instrumental PP fails to split a LPrT from an NP are presented by den Dikken as counterevidence:

- (34) a. They set {up} the bomb {up} with a transmitter.
b. *They set up with a transmitter the bomb.

In Norwegian, similar examples (as in (34b)) cannot be immediately rejected. Particularly when the left-handed particle is prominent, or when there is an inflected adjective, it is quite possible to insert an intervening adverbial. In (35a), I show an intervening instrumental (parallel to (34)), and (35b) features an intervening resultative PP, which is however impossible in Swedish (35c). In (36), an adverb splits the inflected adjectival particle from the DP.

- (35) a. **Norw.:** Han slo ut med hammaren ein spikar.
 he hit out with the hammer a nail
 ‘He hit a nail out with the hammer’
b. **Norw.:** Han kasta ut til meg boka.
 he threw out to me the book
 ‘He threw the book out to me’
c. **Swe.:** *Han kastade ut till mig boken.
 he threw out to me the book
 ‘He threw the book out to me’

- (36) **Norw.:** Han slo flatt igjen jarnet.
 he hit flat._{NEUTR} again the iron
 ‘He hit the iron flat again’

(35a, b) and (36) show that an adverbial split is permissible, so we should probably not reject the possibility of DP shift in all cases. I will return to a possible DP shift analysis in section 4.5.2.

Den Dikken does not provide a detailed structure of the simplex construction, but from the discussion surrounding the simplified structure given on his p. 86, I assume that he does not assume a second SC in simplex constructions. This means that the example in (33) will have a simpler analysis than the complex structure in (29). Instead, the ergative particle heads a SC and presumably takes the nominal as its complement. (37) is my interpretation of den Dikken's analysis of the simplex construction.

(37)

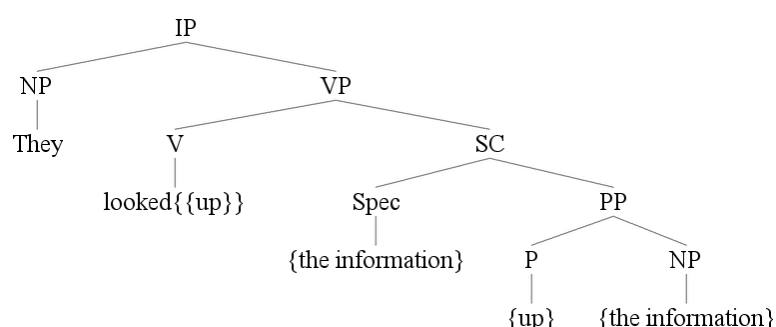

In RPrT constructions, the NP moves across the particle to the particle-headed SC's subject position. LPrT constructions are still the result of abstract particle incorporation into (or reanalysis with) the verb with the NP remaining *in situ*, as explained above. The incorporation cannot be overt, according to den Dikken, because it would violate Williams' (1981) Right-hand Head Rule (RHR), which predicts that the head (in this case V) of a complex X^0 -category (V + P) will appear to the right. If LPrT were the result of overt incorporation into the verb, the RHR would clearly be violated, but it does not seem to affect abstract incorporation. Overt particle incorporation in Norwegian and Swedish participles and infinitives, as well as finite verbs with incorporated particles, do obey the RHR. I will not comment on these constructions further here, but I assume that the latter group is lexically restricted and more abstract in nature, following Svenonius (1996a: 19). Den Dikken concludes that particles are independent syntactic heads at D-structure in Romance, Dutch, English and Scandinavian, and that the degree of incorporation varies.

If (37) is the right representation for the simplex particle construction (i.e., if there is only one SC), then it faces some of the same problems as Taraldsen's (1983) analysis, described in 3.1.2. For example, it should be possible to topicalise the particle and its complement as one constituent, counter to fact (**Up the information they looked*). Moreover, NP movement in RPrT constructions must still be motivated for Case reasons (as in the

complex constructions). The NP must move to the Spec-position of the SC in order to get Case from V; the functional projection (FP) + PP together form a barrier for government. Remember that RPrt constructions are a result of V selecting a functional SC. We will see later that Svenonius (1996a) argues that *all* SCs are equipped with functional structure, which would make the LPrt constructions impossible in den Dikken's analysis (cf. the ban on covert particle incorporation into V, outlined in 3.3.2).

Even though (37) only features one SC, movement or reanalysis is still necessary in order to derive both of the word orders. A general criticism of den Dikken's analysis is thus that it is uneconomical and stipulative; it demands a lot of operations to explain a rather simple alternation. Furthermore, the Prt–NP basic order makes some incorrect predictions, just like Taraldsen's (1983) Prt–NP approach (see 3.1).

3.3.4 *The Ergative Particle*

Den Dikken's discussion of the simplex construction (his section 2.4) contains some important and interesting sub-sections concerning the status of the particle. One of them is called "On the ergativity of particles" (his p. 92) and will be discussed in the present sub-section. In 3.3.5, I will discuss particle modification (his p. 106). For den Dikken, these sections are meant to support the status of the particle as ergative, and thereby also to promote the Prt–NP base order. Especially concerning the first part, I am critical of his use and judgment of the Norwegian data, and thus I will argue that they do *not* support the claims that he advocates. We have seen that Åfarli (1985) rejects Taraldsen's (1983) arguments for a similar Prt–NP base order, and we will see (here and in section 3.4) further arguments from Svenonius (1992, 1996a) in support of NP–Prt order as well.

Den Dikken's discussion of ergativity begins with a treatment of English and Dutch idiomatic VPrt constructions; however, I will focus on constructions that are more similar to the ones in 2.3.1, i.e., constructions where the particle takes an apparent resultative complement. Some of den Dikken's examples are given in (38):

- (38)
- a. They kicked the dog out.
 - b. They kicked the dog out the door.
 - c. They kicked the dog out of the house.

Svenonius (1992) analyses *the door* and *of the house* in (37b, c) as complements of the particle, while den Dikken argues that *the dog* is the internal argument of the particle in (38a, b, c). At this point, some Norwegian data from Åfarli (1985: 83f) are included in the discussion, namely (39).

- (39) a. Vi sparka {ut} hunden {ut} av huset.
 we kicked {out} the dog {out} of the house
 ‘We kicked the dog out of the house’
- b. Jon sparka {*ut} hunden {ut} døra.
 John kicked {out} the dog {out} the door
 ‘John kicked the dog out the door’

As mentioned in 2.3.1, examples like (39a) are generally slightly preferred with RPrt in Norwegian, at least when the construction is directional. However, Åfarli (1985) claims that LPrt and RPrt vary freely, which den Dikken in turn uses as an argument for maintaining the ergative status of the particle.

(38b) and (39b) pose an apparent problem for the analysis (because he must avoid an analysis where *the door/døra* is the complement of *out/ut*), but den Dikken explains the status of these examples in the following way: A’-extraction of the complement of a PP with subsequent P-stranding is “widely possible” (p. 98) both in English and Norwegian, but A’-extraction of *the door* in (38b → 40a) and *of the house* in (38c → 40b) is *not* possible:

- (40) a. ?*Which door did they kick the dog out?
 b. *Of which house did they kick the dog out?

Hence, den Dikken claims that the extracted elements are not the complement of *out*. The conclusion is apparently the same for corresponding Norwegian. In (41)–(42), A’-extractions of *av huset* ‘of the house’/*av hvilken hus* ‘of which house’ and *døra* ‘the door’/*hvilken dør* ‘which door’ cause the derivations to crash, according to den Dikken – irrespective of the distribution of the particle.

- (41) a. Av huset sparket han {?*ut} hunden {?*ut}?
of the house kicked he {out} the dog {out}
‘He kicked out the dog of the house’
- b. Av hvilket hus sparket han {??ut} hunden {??ut}?
of which house kicked he {out} the dog {out}
From which house did he kick out the dog?
- (42) a. Døra sparket han {*ut} hunden {*ut}.
the door kicked he {out} the dog {out}
‘He kicked the dog out the door’
- b. Hvilken dør sparket han {?*ut} hunden {?*ut}?
which door kicked he {out} the dog {out}
‘Which door did he kick the dog out?’

The extractions in (42) are claimed by den Dikken to be slightly worse than in (41), and I agree (stranding the preposition *av* ‘of’ in (41) would be better). But I am not sure whether the examples are as bad as reported (as indicated by the stars and question marks), at least not with wh-extraction. With the *Nynorsk kva* ‘what’ as question word and with the preposition *av* ‘of’ replaced by *frå* ‘from,’ (41) sounds better, both with LPrt and RPrt, cf. (43a).⁸⁴ (42b) is also improved with *kva*, as in (43b) – at least with a stressed RPrt. The examples below are based on my own intuitions:

- (43) a. Frå kva hus sparka han {ut} hunden {ut}?
from what house kicked he {out} the dog {out}
‘From which house did he kick out the dog?’
- b. Kva dør sparka han {??ut} hunden {ut}?
what door kicked he {out} the dog {out}
‘Which door did he kick the dog out?’

⁸⁴ Stranding the preposition is even better:

- (i) Kva hus sparka han {ut} hunden {ut} frå?
what house kicked he {out} the dog {out} from
‘From which house did he kick the dog out?’

My own judgements of (43) make them more parallel to (39), indicating that *ut* ‘out’ could be understood as a transitive particle in (42) and (43b). If we keep in mind that most Norwegian speakers prefer RPrt in (39a) as well, the acceptability of (43a) with RPrt should not be surprising (however, I find LPrt there at least equally acceptable).

In sum, the data in (43) cast doubt on den Dikken’s conclusion that *the dog* is the complement of *out* in all examples in (38). Instead, it seems quite clear that we have extracted *ut*’s complement in (43). If this is the case, then the Norwegian data do not support the analysis of the particle as ergative. This means that what is introduced only as “an apparent problem” in den Dikken’s sub-section 2.4.4.2 is rather a serious problem.

It is also unclear whether one can use stranding possibilities to identify prepositions (his p. 98). PPs can indeed split quite freely in Norwegian (maybe even more so than in English), but not all PPs in adjoined positions allow P-stranding. Den Dikken makes a contrary claim, namely that extraction might happen *even* if the PP is adjoined. But there is no doubt that the b-versions below are less acceptable than the a-versions, especially with temporal PPs as in (44b) and (45b). A locative (or situational⁸⁵) PP in (46b) is better.

- (44) a. Vinteren snakka dei stadig om.
 the winter talked they repeatedly about
 ‘They talked repeatedly about the winter’
 b. *Vinteren reiste dei stadig om.
 the winter travelled they often about
 ‘They travelled frequently in winter’

- (45) a. Johan sender vi alltid kort til.
 John send we always card to
 ‘We always send a card to John’
 b. *Jul sender vi alltid kort til.
 Christmas send we always card to
 ‘We always send a card for Christmas’

⁸⁵ In Aa (2013), I claim that *på* ‘on’ in many cases (e.g., in *på båten* ‘on the boat’) can refer to a certain situation or activity rather than the location. (46b) is ambiguous as to whether *på båtar* ‘on boats’ refers to ‘on the deck of (smaller) boats’ (locative) or ‘on trips with (e.g.) a liner’ (situational).

- (46) a. Båtar forstår dei seg ikkje på.
 boats understand they REFL not on
 ‘They do not know much about boats’
- b. (?)Båtar likar dei seg ikkje på.
 boats like they REFL not on
 ‘They do not like being on boats’

Den Dikken also notes that “not all temporal PPs are transparent” (p. 98, footnote 71) when it comes to stranding possibilities. In the case of Norwegian, there is no doubt that prepositions in temporal (and maybe even some locative) constructions are harder to strand than, e.g., *ut* ‘out’ in (43b).

In sum, this means that 1) the rejection of *ut*’s stranding possibilities, and hence the rejection of *ut* taking an internal argument, is not well-founded; and 2) the argument that transitive prepositions can be recognised through their stranding possibilities is not airtight anyway.

3.3.5 Particle Modification

It is a well-known “fact” from the VPrt literature that adverbs or degree elements (Deg) can modify RPrt but not LPrt, both in English (47a) and Norwegian (47b):

- (47) a. They looked {*right up} the information {right up}.
- b. Dei kasta {*rett ut} hunden {rett ut}.
- they threw {right out} the dog {right out}
- ‘They threw the dog right out’

Given den Dikken’s analysis of LPrt constructions as the result of covert particle incorporation into (or reanalysis with) the verb, this process is incompatible with particle modification. Another observation states that English *right* (Norwegian *rett*) behaves like a bare head, or in other words an X^0 element. Furthermore, the impossibility of incorporating two heads (i.e., a particle and a modifier) makes den Dikken suggest that “incorporation may only adjoin heads to other heads, hence only take *bare* heads (i.e. particles) as its input” (p. 107). This is practically all that is said about the non-converging alternative in (47). If we

assume that (49a) is the structural representation of *rett ut* in (47b), then only the lower P^0 , and not the P^0 complex, can undergo reanalysis with the verb. This is not independently motivated.

Using data from Chinese and Dutch, den Dikken makes a more extended argument to show that a bare modifier cannot be stranded. This generalisation also applies in Norwegian, whether we believe the particle moves from the left or the right of the DP:

- (48) a. **Dei kasta ut rett <ut> hunden.*
 they threw out right the dog
 'They threw the dog right out'
 b. **Dei kasta ut hunden rett <ut>.*
 they threw out the dog right
 'They threw the dog right out'

There are different theories regarding the possibility of extraction from complex X^0 -categories (excorporation). Den Dikken explains the data in (48) in terms of *Relativised Minimality* (RM) (Rizzi 1990, den Dikken 1995: 109). He suggests three different ways that the (bare) modifier can relate to the particle: as an adjunct at the P^0 level (49a), as an adjunct at the P' level (as in Svenonius 1992) (49b), or as the head of its own projection (49c).

- (49) rett ut 'right out'

a.

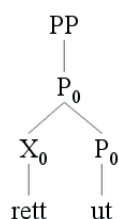

b.

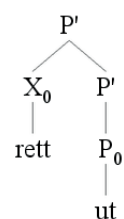

c.

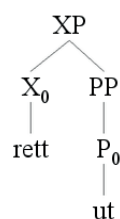

Given X-bar theory, (49b) is the most unusual variant; if we allow a head to adjoin at this level, the restrictiveness of the phrase structure configuration is seriously challenged (a lot of "unwanted" combinations may be generated). But given Bare Phrase Structure, (49b) is not worse than (49c), since the number of levels are regulated by the features of the head. In any case, in all three alternatives, X^0 c-commands P^0 and movement of P^0 across X^0 is banned by RM. All three structures thus ban stranding the modifiers in (48).

I am not sure how well (49a) explains the non-converging LPrt variants in (46)–(47). Their status depends on what is generally allowed to incorporate (a bare head or a head with its adjunct). At least given X-bar theory, (49b) can probably be discarded because it would lead to overgeneration. Hence, we may adopt (49c) (cf. also Abney 1987). Then, the non-converging variants in (46)–(47) can be explained because the verb cannot incorporate two heads from two distinct categories. We will see in 3.6.4 and in 4.1 that the crashes in (46)–(47) are also naturally explained when assuming (49c) and a DP–Prt base order.

3.3.6 Conclusion

Den Dikken's (1995) comprehensive and detailed theoretical work is hard to summarise adequately in a few pages. His analysis is complex, containing a double SC structure with quite different derivations and Case-assigning mechanisms for LPrt and RPrt constructions. Although the various mechanisms and analyses are on the whole well justified on independent grounds and with reference to other theoretical works, they seem to be quite stipulative in some respects.

In LPrt constructions, the Prt–NP base order remains unchanged, but because of the complex double SC structure, abstract incorporation and a subsequent GTC operation are necessary for assigning Case to the NP *in situ*. Furthermore, the syntax can generate a functional projection (FP) above the SC; if it does, LPrt constructions cannot be derived, and if it doesn't, LPrt *must* be derived. In this way, the alternation is accounted for, and it respects principles of economy. But this is still a stipulation. It does not explain the apparent free variation in English VPrt constructions, and it certainly does not explain the LPrt preference in Norwegian. If we assume that Norwegian VPrt constructions usually do not generate a FP above SC1, we are still on a descriptive (or stipulative) level.

I have also argued that the use of Norwegian data is misleading, and does not in fact support den Dikken's ergative analysis of the particle. When this fundamental part of the analysis is weakened, the approach falls apart from a Norwegian point of view.

Assuming a basic NP–Prt base order, the three examples in (37) are connected in a more intuitive manner. From the early 1990s onwards, this base order is assumed in all of Peter Svenonius' works on VPrt constructions (of which I am aware), although the details of the analysis have changed over the years. I will look at one of Svenonius' many works on VPrt constructions in the next section.

3.4 Svenonius (1996a): SC Structure with EPP-Driven Movement

3.4.1 The Basic Structure

Peter Svenonius' thorough work on VPrt constructions from the early 1990s onwards is of great importance; he is arguably the linguist who has worked most extensively on VPrt constructions in the Scandinavian languages. Like den Dikken, Svenonius (1996a) proposes a SC structure with the particle and the DP in a predicational configuration. Contrary to den Dikken, however, Svenonius argues for a DP–Prt base order with possible movements of either the particle or the DP into a higher functional projection (FP). The rough structure of his analysis is given in (50):

(50) The doorman threw

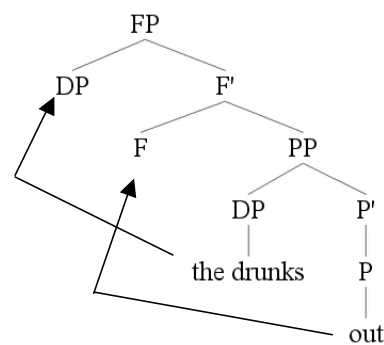

Either DP movement into Spec,FP, or particle movement into F

In the following sub-sections, I will present and discuss the motivations for these two movement operations, which are taken to be EPP-driven (3.4.2), and then I will discuss the different particle distributions in the Scandinavian languages as realisations of different subject positions (3.4.3). Eventually, Svenonius proposes two more functional layers than are shown in (50), so the SC ultimately has a representation similar to that of a verbal clause. The TP and AgrP are the same in each, while the top layer, CpP, has a slightly different motivation from that of the verbal CP.

3.4.2 EPP and L-Selection

Svenonius explains the variation in particle distribution found in the Scandinavian languages (see 2.1)⁸⁶ in terms of the different languages' respective subject positions and realisations of the EPP. In Svenonius' view, VPrt constructions are essentially causatives or resultatives: "Typically, and perhaps always, a verb-particle construction of the form SUBJECT VERB OBJECT PARTICLE [= RPrT construction] means something like SUBJECT *cause* OBJECT *go* PARTICLE *by means of* VERB" (p. 3). Because of the DP–PrT base order, particles are analysed similarly to transitive PPs, but they differ in that the P-element may shift in English only when the Ground (the complement of P) is not overtly expressed. As we have seen, particle shift is obligatory in Swedish and somewhat restricted in spoken Norwegian when the Ground is overt. Den Dikken (1995) analyses *the drunks* in (51) (from Svenonius' p. 4) as the complement of the particle (cf. 3.3.3), but Svenonius analyses it as the SC subject, or the particle's Figure.⁸⁷

- (51) The doorman threw [FIGURE the drunks] out [GROUND of the bar]

I have already argued that den Dikken's (1995) analysis of the particle as ergative is not convincing when it is confronted with Norwegian data (see section 3.3.4), and here I will instead follow Svenonius' arguments that *of the bar* is the particle's complement.

Svenonius posits a functional layer on top of the SC. This means that the Figure is based in the spec-position of a lexical projection headed by the particle. Either the Figure DP or the particle moves up in the functional projection; if the latter is the case, the LPrT construction is the result. The following examples are taken from Svenonius' pp. 8f and repeat the two possible movements illustrated in (50):

- (52) a. The doorman threw [FP the drunks_i [PP t_i [out]]]
b. The doorman threw [FP out_i [PP the drunks [t_i]]

⁸⁶ The overview given by Svenonius (1996a: 10ff) reveals a picture of the Scandinavian variation similar to Thráinsson's (1997: 34, 142) overview, with the exception that Faroese is claimed to have RPrT preference (following Sandøy 1976).

⁸⁷ See a short introduction of the terms Figure and Ground in section 1.1.2. A relevant definition is given in Talmy (2000: 312).

Here, we see a more intuitively correct predication relation between the DP and the particle than in den Dikken (1995). The functional layer on top of the SC is independently motivated by Bowers (1993), who claims that all clauses are equipped with a predication operator that heads its own projection (for Svenonius 1996b, the FP is realised as a PrP). But note that Bowers (1993) base-generates the subject in Spec,PrP. This projection is motivated to formalise the relation between the specifier and the complement of a predication operator, i.e., the subject and its predicate. Therefore, a lexically based subject that moves into PrP is not compatible with Bowers' basic motivation for the predication operator.

For Svenonius (1996a), the motivation for movement into the F domain is the EPP. VPrt constructions, being clauses, all have subjects, and the strong EPP feature is assumed to be present on the F head. Hence, some nominal element must move into the F domain to check this feature. This EPP requirement can be satisfied either by the DP moving to Spec,FP, or by the particle moving to F⁰. In order for this to work, the particle must bear a nominal (N) feature. This may seem *ad hoc*, but movement of a predicative head instead of a DP to satisfy the EPP is independently proposed by Alexiadou & Anagnostopoulou (1995). If we take the old GB decomposition analysis of the lexical categories into account, P and V are the two non-nominal categories: P is [-N,-V] and V is [-N,+V]. Thus, we could perhaps conclude that the verb is not nominal enough to satisfy the EPP on T (although the EPP can be checked in Spec,TP by a DP). In light of this, it seems a bit strange that P is nominal enough to check the EPP on F/Pr.

An important notion to keep in mind is that of *lexical*-selection (Pesetsky 1995). L-selection is the "selection of a particular lexical item, typically a preposition by a verb" (Svenonius 1996a: 5). Adjectival particles apparently shift quite irregularly. The combinations *set free* and *make clear* allow shift, but *free* and *clear* cannot shift in all other combinations. Therefore, Svenonius suggests that combinations like *set free* and *make clear* are listed in the lexicon; the complement is l-selected by the verb. At least, it is intuitively reasonable to assume l-selection to be present in metaphorical/idiomatic VPrt constructions, cf. section 2.1 and Sandøy (1976: 107f). In some cases, metaphorical constructions are only possible with a certain particle, for example: *tenkje* 'think' can appear with *ut* 'out' but not **inn* 'in', **opp* 'up', or **ned* 'down'. In directional VPrt constructions, more particle choice is usually possible: *kaste* 'throw' can appear with *ut*, *inn*, *opp*, or *ned*. Furthermore, a directional particle can be topicalised/A' moved but a metaphorical one cannot (see section 4.3.6), so that the metaphorical particle is apparently more closely connected to the verb. One could therefore suggest that the metaphorical combinations are lexically listed. They are clearly non-

directional and they have more left-bound particles than the directional variants; sometimes the LPrt distribution is even obligatory. In Svenonius' analysis, this means that particle shift is (almost) obligatory. If we then assume that an l-selected element is part of the selector's meaning, i.e., that the meaning of the particle is incorporated into the V somehow, we might assume that V and LPrt constitute a theta-assigning unit together.

This approach is reminiscent of Taraldsen's (1983) reanalysis, which also avoids violation of the theta-criterion. Although l-selection could seem more attractive for metaphorical (and idiomatic) constructions than directional constructions, a general rule that deprives the P element's theta-assigning ability is desirable for all VPrt constructions. Svenonius does eventually suggest that l-selection is present in all VPrt constructions, and that it is a necessary condition for leftward particle movement to take place. In Taraldsen's analysis, reanalysis is what gives the VPrt construction a causative reading. The effect of l-selection is that particle shift is allowed.

The N feature and l-selection as requirements for particle shift might be problematic for some adjectival VPrt constructions. We would have to assume that only a few adjectives bear an N feature in English, while (probably) a slightly higher number of adjectives do so in Norwegian. However, it is hard to see how this could explain Åfarli's (1985) data, where *gul* 'yellow' is a possible LPrt in the Halså dialect, but *gulblå* 'yellow-blue' and *fiolett* 'violet' are not.

- (53) Vi måla gul/*gulblå/*fiolett bilen.
 we painted yellow/yellowblue/purple the car
 'We painted the car yellow/yellow-blue/purple'

The N feature alone is insufficient to allow the particle to shift; it must also be l-selected, as already mentioned. Maybe the adjectives that are more "idiomatically" related to the verb are easier to realise as LPrt (e.g., *laus* 'loose', *fri* 'free'), while adjectives that cannot be l-selected (e.g., most colour adjectives) are harder to shift. If the N feature and l-selection are necessary for the particle to appear to the left, these criteria must be realised differently in English than they are in Scandinavian – and they must also differ across the Scandinavian languages and dialects. It seems to be more or less coincidental which elements are l-selected in a language, and which are not: "*Elect* does not l-select *president* (though it perhaps could, in principle, and therefore might, in some language) ..." (Svenonius 1996a: 10). This particular quote perhaps makes it difficult to see how l-selection is explanatory, but I will suggest in my

analysis in section 4.3.2 that due to the *structural* (grammar) semantics of a DynP node where LPrt is distributed and V's selection of this node, the V + LPrt collocation can in principle always be construed as a lexical unit (although it is technically not).

3.4.3 *Scandinavian Variation and Subject Positions*

On Svenonius' p. 12, there is an interesting section on "Danish and Subject Positions." As is widely recognised in the literature, Danish has generally RPrT. This fact, which contrasts with the situation in the other Scandinavian languages (and English), combined with the fact that adverbs never precede subjects in Danish (again unlike Swedish and Norwegian), leads Svenonius to propose that the EPP is different in Danish. Specifically, he claims that the subject position in Danish is higher than in the other languages under discussion. The following data with non-topicalised subjects are taken from his p. 13:

- (54)
- a. **Swedish:** Har {någon student} möjligen {någon student} läst boken?
 - b. **Norwegian:** Har {noen student} muligens {noen student} lest boken?
 - c. **Danish:** Har {nogen student} muligvis {*nogen student} læst bogen?
has {some student} possibly {some student} read the book
'Is it possible that some student has read the book?'

Assuming adverbials to be adjoined to TP, Svenonius proposes that Danish has a strong feature in Agr which the other languages lack, forcing the subject to check this feature in Spec,AgrP. Compare this to the VPrt analysis of the English examples in (52). If we assume a similar representation for the Scandinavian languages, Danish can only check EPP in the F-domain by raising the SC subject (and not by moving the particle). Now, it is clear that Danish subjects for some reason are forced to move higher than in the other Scandinavian languages. Svenonius sees this in connection with two nominal features giving rise to EPP effects (mentioned in Chomsky 1995). He assumes an N feature, which can be checked by any nominal element and which is T-associated, and a D feature which can only be checked by a DP and which is Agr-associated. The idea is that the D feature is strong in Danish, forcing the DP to check it overtly by moving to Spec,AgrP. This again leads to the proposal that there are two functional heads above the SC, giving the following VPrt representation (from Svenonius' p. 14):

- (55) a. **Norwegian:** kaste [_{AgrP} Agr⁰ [_{TP} hunden_i T⁰ [_{PP} t_i ut]]].
 b. **Norwegian:** kaste [_{AgrP} Agr⁰ [_{TP} ut_i-T⁰ [_{PP} hunden t_i]]].
 c. **Danish:** smide [_{AgrP} hunden_i Agr⁰ [_{TP} t_i' T⁰ [_{PP} t_i ud]]].
 'throw {out} the dog {out}'

In the Norwegian example (55b), the N feature is checked by the particle (which is nominal, including the incorporated Ground). If this is on the right track, (54b) is analysed in a similar way, except that the particle itself is able to check the EPP in (55b). In (54b), the subject moves to Spec,TP to check the N feature. Only Danish has the obligatory checking of the D feature in the Agr domain. A quite striking result is that the SC is equipped with the same functional projections as a verbal clause, which to my knowledge is a rather unusual assumption, since the TP is normally associated with a tense feature.⁸⁸

Faroese fits in this new picture quite well. We have seen through Sandøy (1976) in section 2.1 that Faroese has a general RPrt preference, and Svenonius argues (on his p. 16) that the subject position in Faroese is quite high, like in Danish. Although the Faroese data are not as unambiguous as the Danish data, there are indications that the two languages can be analysed in parallel. The only difference between the two when it comes to VPrt constructions is that while Danish particles stay low (*in situ*), agreement triggers Faroese particles to move into the Agr-domain, where the strong D feature has already attracted the subject.

What about Swedish? LPrt is claimed to be obligatory and due to particle movement. Svenonius assumes that it is always sufficient for the EPP to be checked by the particle in Swedish. An independent motivation for this is taken from infinitival constructions, in which the Swedish infinitival marker seems to appear higher than in Norwegian and Danish. The following examples are taken from Svenonius' p. 18:

- (56) a. **Swedish:** Maria lovade att inte läsa boken.
 Maria promised to not read the book
 b. **Danish:** Marie lovede ikke at læse bogen.
 Maria promised not to read the book

⁸⁸ Svenonius motivates the double functional SC layer independently from the variation found in participle constructions, but I will not discuss this issue here.

c. **Norwegian:** Marie lovet {å} ikke {å} lese boken.⁸⁹

Maria promised {to} not {to} read the book

'Maria promised not to read the book'

Svenonius stipulates that the same strong feature on Agr attracts the Swedish infinitival marker and the particle. Infinitives and VPrt constructions denote different kinds of aspect (an unrealised state of affairs vs. a resultative end state), which could suggest that there is a strong aspectual feature in Agr in Swedish, attracting both *att* and the particle. In fact, the strong aspectual feature is associated with a third functional projection, based on Kayne's (1993) development of a D/P projection (with determinative and prepositional properties) above AgrP and TP in participial constructions. Svenonius motivates a similar projection in VPrt constructions, namely a CpP projection, with the C indicating that the constructions have similar properties as clausal CPs. But the little *p* (for "particle" and "participle") separates it from the ordinary C and illustrates that a particle or a participle is always involved. The Swedish particle is then attracted by strong aspectual features all the way to Cp⁰. Thus, we get the following Scandinavian variation (from Svenonius' p. 29):

- (57)
- a. **Dan:** smide [CpP Cp [AgrP hundeni Agr [TP ti' T [PP ti ud]]]]
 - b. **Far:** blaka [CpP Cp [AgrP hundini út_k [TP ti' t_k [PP ti t_k]]]]
 - c. **Nor.:** kaste [CpP Cp [AgrP Agr [TP hundeni T [PP ti ut]]]]
 - d. **Nor:** kaste [CpP Cp [AgrP Agr [TP ut_k [PP hundeni t_k]]]]
 - e. **Swe:** kasta [CpP ut_k [AgrP t_k' [TP T t_k' [PP hundeni t_k]]]]
- 'throw {out} the dog {out}'

3.4.4 Evaluation (and the Data Problem)

The overview in (57) is in my view sufficient to classify Danish and Faroese as high subject languages, and serves as a possible explanation for the high Swedish particle (and infinitival marker). However, the Norwegian situation remains vague. The strong N feature in T might

⁸⁹ From the NDC, it is clear that Norwegian dialects generally feature a high infinitival marker, as in Swedish. The written standards have to some extent traditionally featured the "never split an infinitive" rule, but in prominent *Nynorsk* grammars, such as those of Heggstad (1931: § 453) and Beito (1970: § 358), it is claimed that the split infinitive is generally the rule in *Nynorsk*, especially when the adverb is a negator. This is also confirmed in *Nynorskorpuset* 'The *Nynorsk* Corpus' (cf. 1.4.3.1). See also a discussion on the Norwegian infinitival marker in a historical context in Faarlund (2003, 2007).

explain the (claimed) Norwegian position occupying the middle ground in the Scandinavian context, but it does not explain the potential semantic difference between LPrt and RPrt constructions, nor does not explain why LPrt is (often strongly) preferred. Svenonius does mention the LPrt preference in Romsdal Norwegian (from Sandøy 1976), but claims that it is not representative for Norwegian in general: “for most Norwegian dialects (...) there is free variation (...)” (p. 11). Except for Faroese, Svenonius’ Scandinavian overview looks similar to Thráinsson’s (2007), with the admission that the notion of “free variation” in Norwegian and Icelandic is somewhat idealised. From what we have seen in chapter 2, Norwegian dialects with LPrt preference are the rule, not the exception.

Furthermore, LPrt distribution is claimed to be impossible in Norwegian complex VPrt constructions, as in English (i.e., the particle cannot shift when the Ground is overtly expressed) — but *dispreferred* and *optional* would probably be more accurate descriptors of Norwegian directional and metaphorical constructions, respectively. It is hard to see how the analysis in (57c, d) can cope with these empirical facts. With the LPrt preference in directional simple constructions and RPrt preference in corresponding complex constructions, we must assume that the realisation of the EPP depends on whether the Ground is overt or not. The account in (57) is therefore still merely descriptive in this regard: the semantic difference between RPrt and LPrt constructions, like the difference between simple vs. complex constructions, remains unexplained.

Svenonius does not specify which dialects his Norwegian informants speak, but my guess is that they are mainly speakers of North Norwegian, which would correspond to the data he puts forward in his 2010 paper.⁹⁰ Nevertheless, my overall impression of the generalisations for Norwegian put forward on Svenonius (1996a: 11), is that they seem somewhat standardised. He also claims that a right-hand particle is obligatory in light pronoun constructions. In section 1.1.2, we mentioned that this does not correspond the dialects spoken in all parts of Central and East Norway (see Aasen 1848, Sandøy 1985). Svenonius’ (2010) work provides a significantly more nuanced view of the particle distribution in Swedish and Norwegian full DP constructions, claiming that Central Norwegian (*Trøndsk*) and North Swedish have LPrt preference, and hence differ from their respective standards. Their subject positions are not discussed, but they are seen in connection with participle incorporation and the form of the supine. In general, I would not agree that (57c, d) are fully representative of

⁹⁰ Three Norwegian linguists and many unnamed speakers are thanked explicitly as informants in Svenonius’ (1996a: 10) work. The conclusions from these informants correspond with the generalisations for North Norwegian in his 2010 paper.

Norwegian, but since there is apparent free variation in the written standards, they often count as “default Norwegian.”

3.5 Zeller (2001): The Particle as Head of a Lexical Complement of the Verb

3.5.1 Introduction

Zeller’s (2001) work is an important example of the traditional Complex Predicate (CPr) family of approaches to VPrt, as opposed to the SC approaches; cf. Ramchand & Svenonius (2002) and the introduction of the present chapter. Zeller’s account differs from those presented so far in that he does not promote a subject–predicate analysis of the DP–Prt relation, nor are VPrt constructions counted as resultative. Instead, the V–Prt relation is crucial; the verb and the particle are argued to be structurally adjacent to one another (with the particle projection as a lexical complement of V, cf. Zeller’s p. 209). Zeller (2001: 51f) himself splits the CPr analyses into those which take a morphological approach (with the verb and the particle as a complex verbal head) and those which instead choose an incorporation approach (with the particle heading its own projection, but able to incorporate into the verb). Zeller shares the incorporation approach view (also shared by the SC analyses discussed in this chapter) that the particle heads an independent projection, but he denies the possibility that the particle can incorporate into the verb. Instead, he defends a syntactic approach to VPrt constructions, in which the particle heads its own projection and stays *in situ* when the verb moves to C in V2 contexts.

In the following sub-sections, I will discuss some aspects of Zeller’s analysis, starting with the LPrt and RPrt alternation in section 3.5.2. Here, the structural adjacency is basic in RPrt constructions, while a reanalysis device, which creates a morphological adjacency (with V_0 and P_0 as sisters in a complex P_0 , cf. Zeller’s p. 210), is necessary to derive LPrt constructions. In 3.5.3, I continue discussing the independent particle projection as a lexical projection structurally adjacent to V. The consequences of reanalysis involving the lexical elements V and P will also be discussed. In 3.5.4, I evaluate another important principle of Zeller’s definition of particles, namely that they stay *in situ* in overt syntax. In 3.5.5, I criticise the non-predicational structure of his VPrt analysis and argue that the paraphrases used to support that claim are misleading. 3.5.6 concludes the section.

3.5.2 The LPrt and RPrt Alternation

One of the major challenges for any VPrt analysis is to capture the essence of the LPrt and RPrt alternation, which is highly relevant for English and the Scandinavian languages. However, this is not a main topic for Zeller, which might have to do with the fact that he focuses on German: particles are stranded in German main clauses, and the North Germanic languages are secondary in his study. The technical details of how particle alternation is possible are postponed to the 6th chapter, and the North Germanic data are discussed in the 7th and final chapter. Zeller's strategy is apparently to motivate certain syntactic and morphological principles in German VPrt constructions, and then to "extend" these principles to include English and the Scandinavian languages as well. The structure he posits for RPrt constructions is given in (58) (from his p. 284).

(58)

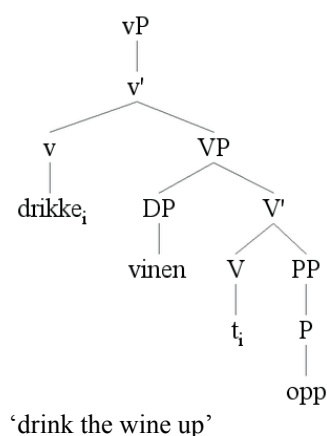

Unlike the typical SC account, with the Theme DP base generated within the maximal projection of the particle, the DP is here externally located in Spec,VP. To get the surface word order in Norwegian, the main verb will have to move across the DP, to little *v*. But even more importantly, the particle is structurally adjacent to V in (58). This will be discussed further in section 3.5.3, but the main point is that the particle heads a lexical projection, unlike a verb-complement (DO), which according to Zeller (pp. 1ff) contains a functional projection. In the particle case, this secures the structural adjacency between V and P, which V and a DO do not have (the functional architecture makes the lexical head of a DO non-adjacent to V).

However, LPrt constructions cannot be derived straightforwardly from (58). There is no position between *v* and Spec,VP (the position of the object DP) to which the particle can move. In fact, structural adjacency is not sufficient to derive LPrt constructions; the adjacency between V and P must be transformed to a morphological adjacency, according to Zeller, and this happens after a certain reanalysis of the structure. The following definition is taken from Zeller (2001: 255, 273):

(59) *Principle of Reanalysis*

Given two terminal nodes X, Y, and a lexical entry L that requires X and Y to be structurally adjacent. Then the lexical entries of X and Y can be unified with a syntactic structure in which X and Y are part of the same word X^0 .

In German, (59) is only possible if the particle (Y) is part of a derived word, e.g., in derived nominals (*einführen* — *Einführung*) and adjectives (*aufblasen* — *aufblasbar*). The structural adjacency forms the basis of how these forms can be reanalysed as morphological compounds. The particle verb is hence reanalysed as a V^0 , and this operation is restricted by another condition (see his p. 257) such that it only occurs inside large morphological structures. The technical details of these processes are put forward in Zeller's 6th chapter, and then the analysis is applied to the LPrt–RPrt alternation in other Germanic languages in the following chapter.

To derive an LPrt structure from (58), Zeller posits reanalysis of a type similar to what is employed in Larson's (1988) analysis, which suggests that the V' node dominating V^0 and PP "can be reanalyzed and undergo movement as a complex V^0 " (Zeller 2001: 285). This means that the LPrt word order is a result of the reanalysed complex V^0 crossing the DP by moving to v^0 :

(60)

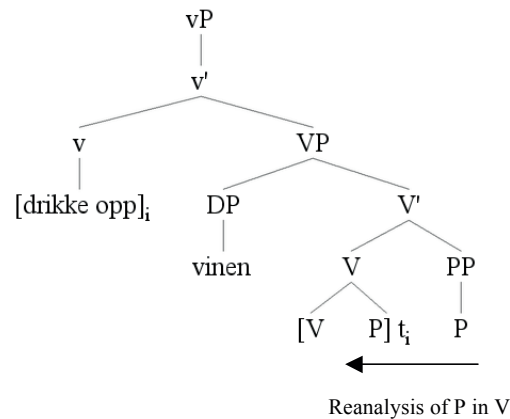

It might seem as an unfortunate consequence that RPrt and LPrt constructions are derived in such different ways, and that the V–P relation is also different in (58) and (60). Although both structures are motivated independently, I will discuss the notions of structural and morphological adjacency in the following sub-section, and show that Norwegian data pose problems for them both.

3.5.3 *The Particle as a Lexical V-Complement*

Zeller strongly advocates a uniform and non-predicational analysis of VPrt constructions. The structural adjacency between V and P is represented by P lacking a functional projection. The following particle definition is given on Zeller's p. 10, and repeated on p. 127 and 148:

- (61) Particles are heads of non-functional phrasal complements of the verb and do not leave their base position in overt syntax

The non-functional particle phrase ensures structural adjacency between V^0 and P^0 and differentiates particles formally from ordinary direct objects, which have functional structure. However, there are some apparent problems with both parts of the definition in (61). Firstly, data from colloquial Norwegian show that adjectival particles sometimes must be analysed as functional. Secondly, particle constructions in Swedish and West Norwegian show that the particle *does* leave its base position overtly in some cases. Thirdly, it is quite standard to assume overt particle movement in North Germanic LPrt constructions.

Let us start with the adjectival resultatives, which Zeller classifies as structurally comparable to VPrt constructions (p. 59) in the sense that both the resultative adjective and the prepositional particle head autonomous phrases and are not part of the VP. Verb movement to C is then straightforward, without any excorporation or split. Later (on pp. 143–147), he discusses what separates adjectival particles in German from adjectival resultatives. The short answer is that the adjectival particles do not yield a resultative reading of the construction, while, as the name suggests, that is the nature of adjectival resultatives. Resultative adjectives are referential, i.e., they are predicated of a syntactically realised argument (the subject). The referentiality is formalised by functional structure, which the non-referential (non-resultative) adjectival particles lack. This leads Zeller to suggest that only the resultative (62b) is equipped with an AgrP, while the particle construction in (62a) contains a bare lexical AP (cf. the discussion on Zeller’s p. 146).

- (62) a. Peter hat krank gefeiert
 Peter has sick celebrated
 ‘Peter played hooky’
- b. Peter hat seine Nachbarn krank gefeiert
 Peter has his neighbours sick celebrated
 ‘Peter has had so many parties that his neighbours finally became sick’

First of all, the purported non-resultative nature of adjectival particle constructions is counterintuitive, since a resultative reading is a central characteristic of prepositional particle constructions (cf. Svenonius 1996a). That is, Zeller argues that the prepositional particle construction in (63) (from his p. 60) resembles a resultative adjectival construction syntactically, with the particle *ab* ‘off’ heading its own phrase outside the VP. In my view, (63) simply *is* a resultative.

- (63) Peter lief seine Sohlen ab.
 Peter ran his soles off
 ‘Peter ran off his soles’

With references to Áfarli (1985) and Svenonius (1996a), Zeller claims that resultative adjectives that are distributed to the left of the DP typically appear in their bare form,

although an inflected form is obligatory to the right of the DP. (64) (from Zeller's pp. 294f) is taken from Åfarli (1985).

- (64) a. Vi vaska rein golvet.
we washed clean the floor
'We cleaned the floor'
- b. Vi vaska golvet rein*(t)
we washed the floor clean*(AGR)
'We cleaned the floor'

This example is used to illustrate that the reanalysis in (59)–(60) works on lexical structures. However, resultative adjectives *can* appear with neutral agreement to the left of the DP in many Norwegian dialects. From Sandøy (1976: 104), we have (65a), and (65b) is from my pilot fieldwork in Oppdal, representing the older generation of speakers there.

- (65) a. **Romsdal:** Dei skava {laust} tapetet {laust}.
they shaved {loose.NEUTR} the wallpaper {loose.NEUTR}
'They loosened the wallpaper'
- b. **Oppdal (old):** Dei slo {flatt} jarnet {flatt}.
they hit {flat.NEUTR} the iron {flat.NEUTR}
'They hit the iron flat'

Since adjectives like these can appear both left- and right-handed, they behave syntactically and semantically (as resultatives) much like prepositional particles. Furthermore, an adjectival LPrt can also appear inflected, which means reanalysis of a bare lexical complement into V as posited by Zeller cannot be universal, at the very least. If we include inflected adjectives in the category of particles, the first part of Zeller's definition in (61) is inappropriate. Structural adjacency must then be rejected, because the adjectival particles need to be represented with functional structure in order to account for their agreement with neutral DPs.⁹¹

⁹¹ There is a possibility that Zeller's definition is more correct than my conclusion based upon a surface view of the Norwegian data. By hypothesis, we could suggest that all inflected adjectival particles are in fact RPrt, and

Zeller's idea that resultatives are equipped with a functional projection and therefore cannot form a complex V^0 with the basic verb (i.e., cannot undergo reanalysis) is also illustrated by the examples below. In (66a), left-handed full PPs are claimed to be impossible, as are left-handed APs (66b, c, d). The examples are taken from Zeller's pp. 290–293, and are originally from Neeleman (1994), Svenonius (1996a) and Åfarli (1985):

- (66)
- a. John cuts {*into pieces} the pear {into pieces}.
 - b. The doorman beat {*senseless} the drunks {senseless}.
 - c. The firefighters hoisted {*high} the equipment {high}.

 - d. Vi måla {*fiolett} bilen {fiolett}.
 we painted {violet} the car {violet}
 ‘We painted the car violet’

 - e. Vi måla {blå} bilen {blå}.
 we painted {blue} the car {blue}
 ‘We painted the car blue’

Zeller follows Neeleman (1994) and Svenonius (1996a) by proposing that the left-handed combinations are lexically listed. Neeleman claims that adjectives like *open* morphologically subcategorise for a verb. Having this property specified in the lexicon, such adjectives can appear verb-adjacent in combinations like *cut open*, *kick open* and *break open*. This suggestion is compatible with Zeller's notion of reanalysis, which allows bare lexical elements to form a complex V^0 with the verb. The striking contrast between (66d) and (66e) is said to be paralleled in Dutch, in which *groen* ‘green’ but not *violet* can undergo reanalysis with the verb. However, the left-handed *blå* ‘blue’ in (66e) is not generally accepted in Norwegian, but rather is a feature of the Halså dialect (Åfarli 1985: 79). Most speakers are generally reluctant to distribute colour adjectives to the left. In my pilot fieldwork, only a couple of young Surnadal informants marginally accepted *røytt* ‘red.NEUTR’ left-handed. An account which crucially depends on reanalysis (and maybe the idea of lexically listed possible verb-adjacent adjectives) thus cannot cope with the Norwegian data.

hence that the DP might be extraposed in the apparent LPrt variants. (i) gives a possible representation of the variant with a left-hand adjective in (65a):

- (i) Dei skava ___ [LPrt laust] tapetet.

We will return briefly to this possible outcome in section 4.5.2.

In section 2.3.2, we also saw that complex phrasal particles (apparently full PPs) are distributed as particles in Old Norse, Icelandic, Norwegian and Swedish. Some of them are repeated below:

- (67) a. **Swedish:** Barbro tok {av sig} jackan {*av sig} (Hulthén 1948: 166).
 Barbro took {off REFL} the jacket {off REFL}
 ‘Barbro took off the jacket’
- b. **Norwegian:** Vi sette {på han} hatten {på han} (Åfarli 1985: 79).
 we put {on him} the hat {on him}
 ‘We put the hat on him’
- c. **Norwegian:** Vi slo {i h(j)el} ormen {i h(j)el} (cf. Åfarli 1985: 79).⁹²
 we beat {to death} the snake {to death}
 ‘We beat the snake to death’
- d. **Romsdal Norwegian:** å sende {+om bord} detta skaffetyet {om bord} (Sandøy 1976: 103).
 to send {on board} this tableware {on board}
 ‘to send this tableware on board’
- e. **Icelandic:** Svo henti hann {frá ser} hnífum {frá ser} (Sandøy 1976: 90).
 then threw he {from REFL} the knife {from REFL}
 ‘Then he threw the knife away’

The PPs in (67) more or less follow the standard pattern of particle distribution; hence, they can be said to be complex, phrasal particles. Swedish has obligatory LPrt distribution, while Romsdal Norwegian has a preference for LPrt and Icelandic has (apparent) free option. The left-distributed variants in (67) are thus apparently not compatible with the reanalysis in (59).⁹³

⁹² Zeller (2001: 291) himself adopts this example from Åfarli, and naturally transcribes it as Åfarli does, with *ihjel* written as a compound. However, in both Norwegian standards today it is written as two words, *i hel* (*Nynorsk*) or *hjel* (*Bokmål*), and could therefore be construed as a full PP (i.e., with functional structure).

⁹³ However, in section 4.4.2, I will suggest that the phrasal particles are in fact reanalysed as heads. That makes them compatible with Zeller’s analysis too.

3.5.4 *The in Situ Particle*

The second part of the definition in (61), which claims that particles stay *in situ*, is also questionable. I follow the principle that the particle must be generated separately from the verb, which is obvious in both German and North Germanic V2 contexts (with inserted adverbials or reflexive verbs). The German example (68a) is Zeller's (from his p. 57), the Norwegian (68b) is Åfarli's (1985) and the Swedish reflexive (68c) is taken from Svenonius (2003):

- (68)
- a. **German:** Peter fährt den Mann um.
Peter drives the man PRT
'Peter runs the man over (knocking him down)'
 - b. **Norwegian:** Kari sparka heldigvis {ut} hunden {ut}.
Kari kicked luckily {out} the dog {out}
'Kari luckily kicked the dog out'
 - c. **Swedish:** Hon har armbågat sig inn (i mängden).
she has elbowed REFL in (into the crowd)
'She elbowed herself into the crowd'

German particle verbs split up in main clauses, unlike prefix verbs, and seem to leave the particle *in situ* in line with (61). This is easy to explain in syntactic terms, but would be more complicated if we assumed that the particle were part of the verb originally. But (68b, c) show that V splits from the particle also in LPrt constructions, which means that Zeller has to account for excorporation of some kind, since he argues that LPrt constructions are the result of reanalysis of P in V. Zeller argues extensively against the morphological approach (pp. 61ff) with P analysed as part of V, but his analysis of morphological adjacency between V and LPrt in (60) faces some of the same problems. Zeller needs a device to split up the complex V so that the verb can move alone to C.

On his pp. 68f, Zeller also argues against the possibility that an externally generated P can incorporate into V (the incorporation approach), for the same reasons that he rejects the morphological approach: It falsely predicts movement of the complex verb to C, and therefore must split the complex V somehow. As we have seen in section 3.3.1, den Dikken (1995) argues for abstract incorporation of P into V in LPrt constructions, assuming the Government Transparency Corollary (GTC), which assigns Case to the DP in its base position in the lower

SC (SC2). But in fact, Swedish and Norwegian dialects have overt particle incorporation in participle constructions as well, though to a varying degree. The following pair is taken from Svenonius (1996a: 22):

- (69) a. **Swedish:** Träden blev *huggna ned / nedhuggna.
the trees were chopped_{.AGR} down / downchopped_{.AGR}
‘The trees were chopped down’
- b. **West Norw.:** Trea vart ??hogne ned / nedhogne.
the trees were chopped_{.AGR} down / downchopped_{.AGR}
‘The trees were chopped down’

Zeller suggests a semantic distinction between \pm incorporation based on Svenonius’ (1996a: 20) claim that “in Faroese and in Norwegian dialects with optional incorporation, a stative sense favors the incorporated form, while an event-oriented reading favors the non-incorporated form.” According to Sandøy (1976: 171), this is true for Faroese, but the tendencies are much weaker for Romsdal Norwegian, in which the distinction is more or less arbitrary. However, the compound participles are claimed by Zeller to be adjectival and analysed as A^0 s. In order for these to be derived, the particle verb is reanalysed as a V^0 , “and this complex V^0 combines with the adjectival zero-operator which yields the stative reading” (p. 289). Reanalysis further requires the particle verb to be a “well-formed morphological object” (p. 289) and thus the surface order changes from V–P to P–V in Swedish and West Norwegian. The viability of this operation is questionable, especially since Sandøy’s remarks on similar constructions do not support analysing the compound variant as adjectival.⁹⁴

3.5.5 *The Non-Predicational Structure of PPs and VPrt Constructions*

I will end the discussion on Zeller’s work by discussing his analysis of VPrt constructions as non-predicational. The structures in (58) and (60) demonstrate the “non-relation” between the particle and the Theme DP, which is essential for his understanding of resultative PPs.

⁹⁴ Den Dikken (2002: 163) shows that Zeller’s (2001: 255, 273) reanalysis in (59) (“Given two terminal nodes X, Y, and a lexical entry L that requires X and Y to be structurally adjacent. Then the lexical entries of X and Y can be unified with a syntactic structure in which X and Y are part of the same word X^{0b} ”) cannot deal with complex LPrt constructions (e.g., *They sent out a schedule to the stockholders*) either. I refer the reader to den Dikken’s article for further discussion.

Svenonius (1996a: 1f) (adopting terms from Talmy 1972, 1985) claims that prepositions denote spatial relations “as holding between a Figure and a Ground.” The subject in (70) is the Figure, which is related to the complement of the preposition (i.e., the Ground) by the preposition itself. Hence, the preposition is relational. In (70a), the Ground expresses the location of the Figure, but it can also express more abstract notions, e.g., a peculiar situation in which the Figure is found (e.g. (70b), my own example).

- (70) a. The cat is in the bag.
 b. The cat is in a hurry.

Zeller (2001: 116f) adopts Jackendoff’s (1983, 1990) framework, arguing that prepositions are not relational, but instead express “local concepts like Places (locative PPs) and Paths (directional PPs).” Then the Theme of P^0 (= Figure in Svenonius’ terms) is PP-externally generated, merged as the external argument of V, cf. (71a). For Svenonius (1996a), the Figure of a construction like (71b) is PP-internally generated and related to the Ground by P^0 via predication. The PP in (71b) is hence a small clause, while in Zeller’s representation in (71a) the Theme is the object of little v (the functional projection FP above the PP is in Zeller’s standard system).

- (71) a. Mary [_v takes [_{VP} Peter [_{FP} [_{PP} to school]]]].
 b. Mary takes [_{PP} Peter to school].

Zeller adopts (71a) without further discussion. However, the SC representation in (71b) will give us a structural representation predicting the most plausible interpretation of the following ambiguous sentence taken from Åfarli & Eide (2003: 184).

- (72) Jon hater griser på kjøkkenet.
 John hates pigs on the kitchen
 ‘John hates that there are pigs in the kitchen’, *or*
 ‘John is in the kitchen while hating pigs’

With *grisene* ‘the pigs’ generated PP-internally, the structure has the unambiguous meaning of “what John hates is there being pigs in the kitchen.” An externally generated DP might predict that the action of hating takes place in the kitchen. But we can also argue that Zeller’s

analysis correctly predicts the ambiguity given by (72). Then the least plausible (but still plausible!) interpretation is predicted directly from the structure, and the more conventional interpretation will be accessed by general world knowledge.

However, it is indeed strange that while resultative PPs have their theme generated externally, resultative APs do not (Zeller 2001: 144). This is one of den Dikken's (2002: 155) criticisms of Zeller's non-uniform treatment of resultatives. Instead of giving resultative constructions a uniform approach, Zeller strives to treat all particles in a uniform syntactic (non-predicational) manner.

There are also some investigations that speak for a separation between predicational (predicative) and non-predicational particles. One example is Sawyer's (1999) study of English L1 acquisition. Children's mistakes are more predictable and stable with predicational particles than with the non-predicational ones: dropping the Theme DP is the typical mistake made in predicational VPrt constructions. This mistake corresponds with subject (as opposed to object) drop in finite clauses, suggesting that the Theme DP in VPrt constructions is a subject, as is the standard in SC analyses. Neither of these properties is captured by Zeller's analysis.

A similar split is suggested by den Dikken (2002: 157ff), who refers to Vinka's (1999) data on Swedish particles that can function as predicatives vs. those that cannot. Following Vinka, den Dikken concludes that there must be two types of particles, as illustrated by (73) and (74):

- (73) a. Jag drack {upp} vinet {*upp}.
 I drank {up} the wine {up}
 'I drank up the wine'
 b. Jag drack {upp} det {*upp}.
 I drank {up} it {up}
 'I drank it up'
 c. *Vinet er upp.
 the wine is up
 'The wine is finished'

- (74) a. Jag satte {på} TVn {*på}.
 I put {on} the TV {on}
 'I turned on the TV'

- b. Jag satte {på} den {på}.
 I put {on} it {on}
 ‘I turned it on’
- c. TVn är på.
 ‘The TV is on’

In (74b), the light pronoun might also combine with a RPrt, which is not expected in Swedish. But as (74c) shows, this particle can also function as a predicative, which the banned RPrt in (73b) cannot, cf. (73c). This is assumed to favour a predicational reading of *on* in (74). A problem with these data is that *upp*, but not *på*, is by necessity directional and therefore impossible to combine with the copula in (73c).⁹⁵

Interestingly, Dehé (2002: 17ff) also makes some remarks against a predicational analysis of VPrt constructions based on the possibility of *to be* insertion. VPrt constructions cannot have *to be* inserted in the predicate, as shown in (77b), and they cannot be paraphrased with a finite CP construction, as shown in (77c), both of which are possible for SCs; cf. (75b) and (76b), respectively.

- (75) a. I consider [_{SC} John a fool].
 b. I consider [John to be a fool].
- (76) a. Nobody heard [_{SC} it rain last night].
 b. Nobody heard [that it rained last night].
- (77) a. He handed [the paper in].
 b. *He handed [the paper to be in]
 c. *He handed [that the information was in].

However, these tests are not entirely conclusive. First, *to be* insertion or any paraphrase with a copula is a strange criterion for recognizing SCs, since it excludes resultative SCs. If we have a resultative variant of the SC type in (75), copula insertion is also unsuccessful:

⁹⁵ I will return to this argument in section 4.3.3.

- (78) a. I made [_{SC} John a liar].
 b. *I made [John to be a liar].

The VPrt construction is more comparable to (78a) than (75a). The particle denotes the result of the matrix verbal action. If we want to paraphrase the directional VPrt construction, we need a verb that denotes movement or a change of state. In Norwegian, the copula must also combine with a locative preposition, while a directional VPrt construction demands a directional preposition:

- (79) a. kome -> inn, *inne
 ‘come -> ‘in_{DIR}, *in_{LOC}’
 b. vere -> *inn, inne
 ‘be -> ‘*in_{DIR}, in_{LOC}’

Another argument by den Dikken (1995: 24f) is supposed to demonstrate that directional (81) and idiomatic (82) VPrt constructions do not behave like (adjectival) resultatives, as in (80).

- (80) a. They hammered the metal flat.
 b. There was a hammering event which resulted in the state of affairs of the metal being flat.
- (81) a. They locked the dog out.
 b. *There was a locking event such that the dog ended up *out*.
- (82) a. They made the story up.
 b. *There was a making event such that the story ended up *up*.

(81b) would be fine in Norwegian, since the locative *ute* ‘out_{LOC}’ would be used in both constructions. If the dog was *thrown* out, a directional *ut* would be used in (81a) – but still the locative *ute* would be used in (81b), because *enda opp* ‘ended up’ cannot be combined with the directional *ut*. In other words, it is the paraphrase itself that causes the problems, and (81a) can still be considered resultative (just not directional). The VPrt construction in (82b), however, is more difficult to paraphrase successfully with a finite CP in Norwegian; it fails

both with *opp* ‘up.DIR’ and *oppe* ‘up.LOC’. This is probably due to the fact that it is a metaphorical construction, so it cannot be paraphrased with a preposition that has an obligatorily locative interpretation. Norwegian metaphorical VPrt constructions corresponding to (82a) are generally impossible to paraphrase similarly to (82b), cf. (83). The directional (84a) is arguably more felicitously paraphrased with (84b).

- (83) a. Dei las opp boka.
they read up the book
‘They read the book loudly’
b. *Det var ei leseending slik at boka enda opp oppe.
‘there was a reading event such that the book ended up up.LOC’

- (84) a. Dei sende opp boka.
they sent up the book
‘They sent the book up’
b. Det var ei sendehending slik at boka enda opp oppe.
‘there was a sending event such that the book ended up up.LOC’

In conclusion, I do not find any convincing arguments for diagnosing directional VPrt constructions as non-predicational, since the paraphrases which are supposed to support this analysis are often misleading. The paraphrase argument is quite common in arguments against a SC representation of VPrt constructions. See also Jackendoff (2002: 90), who puts forth similar arguments to Dehé’s. In chapter 4, I will continue to focus on the difference between directional and metaphorical VPrt constructions – and note that the Norwegian paraphrases in (83)–(84) show a different grammatical result for the directional and metaphorical construction. In section 4.3.6, we will argue that only the directional constructions, but not the metaphorical constructions, are in fact predicational. These particular paraphrases can in fact lend support to that.

3.5.6 Conclusion

I have shown that both parts of Zeller’s particle definition in (61) are problematic. The analysis of the particle as a structurally adjacent, non-functional complement of the verb is hard to maintain. Although we can assume that inflected adjectival particles do not move,

Zeller excludes inflected particles in general; his analysis also fails to capture the complex phrasal particles in Scandinavian.

I have also shown examples of Norwegian and Swedish participle constructions where the particle *does* leave its base position to incorporate overtly into the participle (cf. “particles ... do not leave their base position in overt syntax”).

Rejecting the particle as predicational and analysing VPrt constructions as non-resultatives lead to even more problems, some of which are highlighted by den Dikken (2002). Having said this, we will launch a non-predicational analysis for metaphorical constructions in section 4.3.6, and in chapter 5 we will also explore the possibility that Zeller could be right: that at least LPrt constructions in general are not resultatives. All in all, the many problems with Zeller’s analysis preclude it from explaining the Scandinavian particle distribution. His theory is motivated by German data; an attempt to extend the analysis to the Scandinavian languages is only introduced in the final chapter, and then the strategy seems to be to select a few data that apparently fit. However, a lot of other data do not fit with the account. The Scandinavian problem is not solved, and the analysis does not provide a solution for the Norwegian alternation in particular. In short, Zeller’s analysis cannot account for the difference in preference and meaning between the two particle positions.

3.6 Ramchand & Svenonius (2002) and Ramchand (2008): L-syntax and Decomposed VP

3.6.1 The Decomposed VP in Ramchand & Svenonius (2002)

In the introduction of the present chapter, Ramchand & Svenonius’ (2002) presentation of the small clause (SC) and complex predicate (CPr) accounts was discussed. So far in this chapter, four SC analyses and one CPr analysis have been presented. I close the chapter by looking at two closely related approaches that try through *l(exical)-syntax* (based on Hale & Keyser 1993) “to capture the positive aspects of both the SC and the CP[r] accounts” (Ramchand & Svenonius 2002: 2).⁹⁶ Their most important break from the SC accounts concerns the non-clausal treatment of the DP–Prt relation. Instead, Ramchand & Svenonius promote a decomposed VP structure, of which the VPrt construction is one part. The decomposed VP

⁹⁶ The page numbers for Ramchand & Svenonius (2002) are taken from the version available at <<http://ling.auf.net/lingbuzz>> (accessed September 2014).

This basic structure is complemented by a lexical PP, which the particle heads, and in which the DP is merged in the spec-position. LPrt constructions are thus a result of particle shift – ordinary head movement from Prt⁰ to R⁰ – to identify the result state. The alternative DP–particle order (RPrt construction) is derived if the DP moves instead from Spec,PrtP⁹⁷ to Spec,RP and identifies the same result state, leaving the alternative movement unnecessary and hence impossible. So, assuming the verb is inserted in V and moves to v, the two alternative derivations can be illustrated the following way (cf. Ramchand & Svenonius’ pp. 7f):

(87)

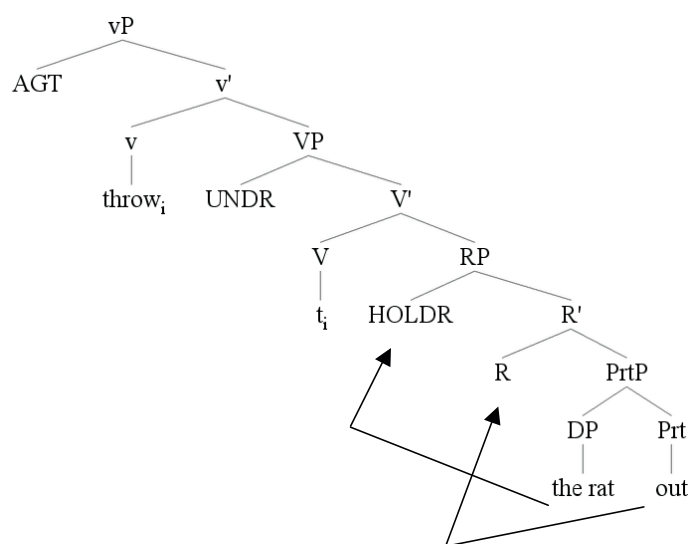

DP movement
in **RPrt** constructions
to identify result state

Particle movement
in **LPrt** constructions
to identify result state

In this way, the R-domain is lexicalised, and the verb and the particle are analysed as syntactically separate, having their own respective relations to the DP. As Ramchand & Svenonius note explicitly, particle movement from a lexical to a functional projection is motivated from Svenonius’ own work from the 1990s (cf. section 3.4). However, for Svenonius (1996a, b), the movement is EPP driven. The Norwegian particle can move to T or

⁹⁷ Ramchand & Svenonius (2002) use a general Prt notation in the analysis; in Ramchand (2008) the particle is categorised as P.

the DP can move to Spec,TP to check the EPP feature (see 3.4.3). This means that although the movements are practically the same, the motivation is different. For Ramchand & Svenonius (2002), the two alternative word orders are derived by moving something into the R-domain – both alternatives are essentially resultative, and they alternate. Thus, the free alternation presents the same problems as for Svenonius (1996a). The analysis cannot account for the LPrt preference shown in a lot of Norwegian dialects, nor the different semantic interpretations of the two word orders. While it is possible to state that a lot of dialects prefer particle movement into the R domain instead of the DP movement, this account does not explain why.

3.6.3 Case Licensing

LPrt and RPrt constructions are treated homogenously with regard to Case licensing of the DP in (87). On their p. 4, Ramchand & Svenonius give evidence from Icelandic and Scottish Gaelic that Case does not change with the surface position of the particle (cf. also Svenonius 2001). This is also evident from Norwegian Dative dialects. The examples in (88) are taken from Sandøy (1976: 103) and the Romsdal dialect. The DP in (88a) gets Accusative independently of the particle position, but the LPrt variant in (88a) differs from the locative PP in (88b); the DP gets Dative only in the latter. This suggests that Case is associated with the preposition in (88b) and the verb in (88a).

- (88) a. Han måtte skubbe_{V-ACC} {frå_{PRT}} båt_{NACC} {frå_{PRT}}.
 he must push {away} the boat {away}
 ‘He had to push away the boat’
- b. Han måtte skubbe frå_{PREP-DAT} båta_{DAT}.
 he must push from the boat
 ‘He had to push from the boat’

Svenonius (2001) and Ramchand & Svenonius (2002) note that although Case is generally associated with the verb in Icelandic VPrt constructions, the DP can sometimes show a different Case if the verb has no particle.⁹⁸ But particle alternation has no influence on this.

⁹⁸ In chapter 5, we will see more examples of apparent P-associated Case in VPrt constructions.

As we saw in sections 3.3 and 3.5, den Dikken (1995) and Zeller (2001) have significantly different derivations for LPrt and RPrt constructions, and must therefore account for different Case-licensing mechanisms as well. Ramchand & Svenonius (2002) argue convincingly that den Dikken's analysis makes the wrong predictions. In den Dikken's LPrt analysis, the NP stays *in situ* and gets Case from the V–Prt complex through the Government Transparency Corollary. In RPrt constructions, the NP moves to the specifier position of the particle-headed SC and gets case from V alone. As Ramchand & Svenonius show, this solution is not empirically well-founded when we take languages with morphological Dative into account.

3.6.4 Head Movement and Constraints

Although the prediction of word order optionality mentioned above is incompatible with (most) Norwegian dialects, Ramchand & Svenonius make some highly attractive points (in addition to the Case remarks) in the latter part of the article which cannot be ignored in any North Germanic VPrt analysis. On their p. 9, Ramchand & Svenonius put forward evidence that particle movement should be analysed as ordinary head movement.⁹⁹ Their English examples are paralleled by the Norwegian facts in (89):

- (89)
- a. Vi kasta hunden rett ut.
we threw the dog right out

 - b. *Vi kasta ut hunden rett.
we threw out the dog right

 - c. *Vi kasta rett ut hunden.
we threw right out the dog
'We threw the dog right out'

Assuming *rett* to head its own phrase (e.g., Deg(ree)P) (which is commonly assumed after Abney 1987), the modifier stranding in (89b) is excluded by Relativised Minimality: Deg blocks particle (head) movement to R. Furthermore, (89c) is excluded because the two heads

⁹⁹ Taking Bobaljik & Brown's (1997) discussion into account, there is perhaps no such thing as "ordinary" head movement, since it is not compatible with the Extension Condition (Chomsky 1995: 327). See a short discussion on this in section 4.2.1.

cannot move together (cf. also the discussion in 3.3.5 and the final one of the three solutions proposed by den Dikken 1995: 109f). In other words, there is good reason to believe that particle shift involves head movement of the particle. This will be our starting point in chapter 4.

However, I will follow a different approach to some other restrictions Ramchand & Svenonius pose on pp. 10f. Firstly, it is observed that a preposition, unlike a particle, cannot shift. Their examples are given below:

- (90) a. We tossed the rat in.
 b. We tossed in the rat.
- (91) a. We tossed the rat in the sewer.
 b. *We tossed in the rat the sewer.

The difference between the successful P-shift in (90b) and the unsuccessful shift in (91b) is explained through the differing inherent properties of particles and prepositions. Particles are said to have some semantic Ground element with a resultative specification incorporated into them, and this attracts them to R to identify the resultative node of the structure. Lacking this resultative feature, ordinary prepositions cannot check R, making (91b) impossible.

In sections 5.1.1 and 5.2.4, I will argue that the crash in examples like (91b) follows naturally if we assume a representational model, with a direct insertion of *in* in the left-hand position (instead of a movement analysis). Then it fails simply because the preposition cannot license two DPs, and no extra device needs to be stipulated.

3.6.5 Resultative APs

As mentioned in section 3.5.3, Zeller (2001: 116f, 144) treats resultative APs differently from PPs in that only the former have the Theme DP base-generated in the internal subject position (In *Mary takes Peter to school*, Zeller locates *Peter* in the VP). Ramchand & Svenonius provide an opposite representation, with the subject of resultative PPs (i.e., VPrt constructions) base-generated internally and the AP subjects externally. In the latter case, the subject is base-generated in Spec,RP. (92) is taken from their p. 11:

- (92) We [_{VP} hammered_i [_{VP} t_i [_{RP} the metal [_{AP} [A' flat]]]]].

With the DP already/obligatorily in Spec,RP, head movement of the adjective is unnecessary/impossible, and the DP–Adj word order is constant. We already saw in section 3.5.3 that this is not so in Norwegian. Also, as Sandøy (1976: 104) shows, there is agreement between the two (at least when the adjective is right-handed, cf. Heggstad 1931: § 609), which is an argument for generating the DP AP-internally (or in the adjective’s functional projection). Thus, the representation shown in (92) for English probably cannot be adopted for Norwegian. The analysis effectively blocks leftward movement of colour adjectives (and other adjectives with a similar restriction), but it does not account for the adjectives that actually can appear left-handed. The alternative is a homogenous base position for all resultative adjectives, with some of them having restrictions in their lexical properties preventing them from appearing to the left. In that case, the analysis must account for a rightward DP shift (see section 4.5.2 for a brief discussion on rightward DP shift).

3.6.6 *Ramchand (2008)*

Ramchand (2008: 131ff) presents a slightly different account from the Ramchand & Svenonius (2002) model, although Ramchand (2008) bases her analysis on the joint paper with Svenonius. The projections in the decomposed verbal structure are basically the same, but renamed *initP* (causing projection), *procP* (process projection) and *resP* (result projection). The most important technical change with respect to the VPrt constructions is that the particle obligatorily moves to *res/R* and checks its inherent resultative properties against the extended verb phrase’s corresponding feature. Thus, the word order alternation depends on whether the DP also moves or not, which means that RPrt constructions are a result of *two* movements.

(93)

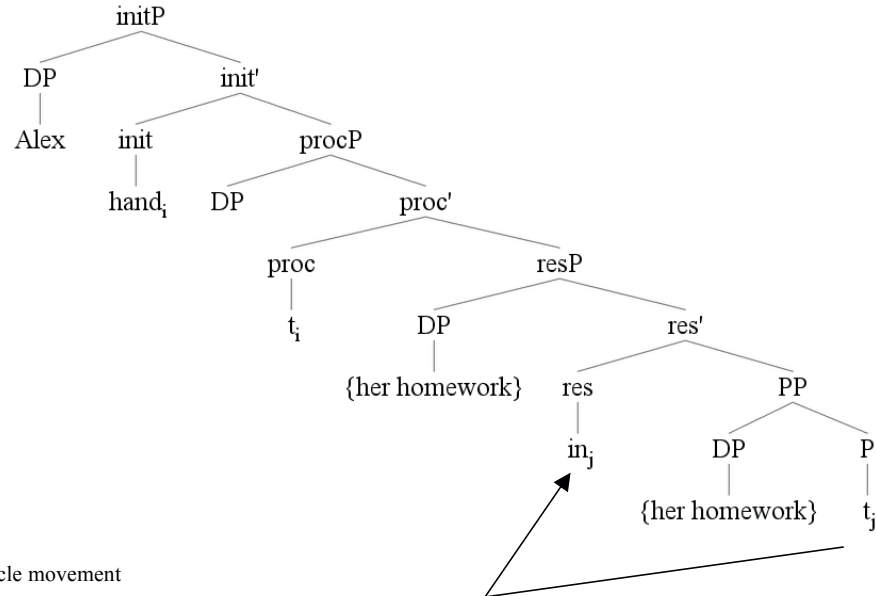

Obligatory particle movement
to identify res

Optional DP movement
to Spec,resP to generate
RPrt constructions

It is not clear what motivates the spell-out of the DP in the lower vs. the higher position (cf. Ramchand's p. 132). In any case, (93) does not provide a solution to the alternation problem. Ramchand & Svenonius' (2002) analysis, which requires only one movement (either of the DP or the particle) into the resultative domain, is more economical. A second movement in (93) is not well motivated in order to explain a simple empirical pattern, DP-Prt and Prt-DP. But regarding VPrt constructions with PP complements, cf. (91), the Ramchand (2008) model could seem more economical if we assume that the particle can be directly inserted into res. On her p. 136, Ramchand reproduces the following example from den Dikken (1995):

(94) [_{initP} Mary [_{init} send [_{procP} {the schedules} [_{proc} <send> [_{resP} {the schedules} [_{res} out [_{PP} {the schedules} [_P to the shareholders]]]]]]]]].

Here, the particle is directly inserted in res and the DP can be spelled out in its highest or lowest position. This is an interesting part of Ramchand's (2008) discussion, and it will be compatible with my hypotheses put forward from section 4.3 onwards. If we admit the

possibility of inserting the particle directly in the left-hand position, there are several fortunate consequences, which we will discuss in the next chapter.

3.6.7 *Conclusion*

Ramchand & Svenonius (2002) and Ramchand (2008) in some sense represent a continuation of Svenonius' work from the 1990s. The DP–Prt base order posited in all of these accounts is the same, and there is movement of the particle and/or DP into a higher functional domain. However, while Svenonius (1996a) motivates these movements using the EPP, they are motivated in the more recent works by the need to lexicalise a result state, which is considered by these authors to be the essential property of all VPrt constructions. And while Svenonius (1996a) promotes a classical SC analysis, the elements of the VPrt construction instead lexicalise the lower part of a decomposed VP in the later works.

The analyses of V-associated Case licensing and particle movement as ordinary head movement presented in this section are, to my mind, quite convincing. The analyses of complex VPrt constructions and AP resultatives with the particle sometimes directly inserted into *res/R* are also interesting. However, the alternation problem remains recalcitrant. Neither of the models discussed in this section were able to capture a potential semantic difference between the two word orders. Hence, the particle distribution still seems arbitrary, and the alternation remains unexplained.

3.7 **Conclusion Regarding Previous Theoretical Accounts**

In this chapter, I have discussed the following theoretical approaches to VPrt constructions: Taraldsen (1983), Áfarli (1985), den Dikken (1995), Svenonius (1996a), Zeller (2001), Ramchand & Svenonius (2002), and Ramchand (2008). All these works discuss Norwegian in one way or another, either as the main object of study or in a comparative context. I have mainly focused on predicational analyses, as I will relate my own analysis to this tradition in the next chapter, but I have also discussed Zeller (2001) in order to see how an alternative analysis fares. In conclusion, I think there are strong indications that the particle generally must be understood as predicational, i.e., that it heads a small clause, and this will be my starting point in the next chapter. Notice that metaphorical constructions have not been at the forefront in this chapter (mainly because they are not taken into account in the generative

works that have been discussed), and in the next chapter I will eventually launch the possibility that they are not predicational.

Concerning the base order of VPrt constructions, Taraldsen (1983) and den Dikken (1995) argue for a Prt–DP order and leftward movement of the DP into a subject position in order to derive RPrT constructions. Áfarli (1985), Svenonius (1996a), Ramchand & Svenonius (2002), and Ramchand (2008) argue for the opposite base order and leftward particle movement in order to derive LPrT constructions. The details for deriving the two word orders differ in all the works that have been discussed; some operate with one obligatory movement, some with one obligatory and one optional movement, and some with abstract movements and reanalysis of the particle (and the verb).

Crucially, what all the works have in common is an understanding of the particle placement relative to the DP as being optional. Although Svenonius (1996a) refers to Sandøy's (1976) observation that LPrT is preferred in Romsdal Norwegian, the relevant data are not accounted for in Svenonius' analysis. However, when we take the data from Aasen (1848, 1864), Western (1921), Sandøy (1985), and the NDC into account, we learn that the LPrT preference is actually the general pattern for Norwegian. The preference for one word order over the other gives us reason to believe that LPrT and RPrT constructions also represent different meanings.

In the next chapter, I will argue for a semantically motivated analysis that accounts for this difference, and in doing so seek to explain why there is LPrT preference rather than optional particle distribution in colloquial Norwegian.

4 The Syntax and Semantics of Norwegian Verb-Particle Constructions

The need for a new analysis of Norwegian verb-particle (VPrt) constructions can be motivated by the fact that previous analyses cannot account sufficiently for differences in the meanings and the distribution of LPrt and RPrt constructions. In the conclusion of chapter 2 (2.7), I summed up a number of empirical generalisations, the first two of which are repeated here as (1a, b):

- (1) a. LPrt and RPrt are not distributed optionally in Norwegian: LPrt is generally (and by most speakers, *clearly*) preferred.
- b. The meaning of a given LPrt construction is different from that of the corresponding RPrt construction.

These empirical facts cannot be ignored, and it will be one of my main tasks to try to account for them in a comprehensive analysis of Norwegian VPrt constructions.

One of the most important challenges for any VPrt analysis is to deal with the alternation problem. In this chapter, I start out by approaching this problem, and I will incorporate more and more data as I proceed. In section 4.1, I discuss the basic word order of VPrt constructions. In line with Åfarli (1985), Svenonius (1996a) and Ramchand & Svenonius (2002), I will defend a DP–Prt basic order and argue that leftward particle movement must be considered as ordinary head movement that moves the particle to the left of the DP. In section 4.2, I will investigate *why* the particle moves. Specifically, I will motivate a semantic distinction between LPrt and RPrt constructions; for the former, I will argue that the particle moves leftward to identify a dynamic node in the structure, a process which “dynamises” the structure and thus explains the difference in meaning between the RPrt and LPrt word orders.

In section 4.3, I will go into more detail regarding the derivation of the VPrt construction. My main goal in this section is to integrate some of the findings from chapter 2, which among other things give rise to the generalisations in (1), into a neo-constructional model (cf. Borer 2005, Åfarli 2007). I will show that the structure can be considered as the primary carrier of meaning, and furthermore that the meaning carried by the structure is modified by the lexical elements inserted into it. The meaning is also modified by other

factors of a more non-linguistic nature, such as background or world knowledge (cf. Bouchard's 1995 *Situational Semantics*). Next, section 4.4 deals with complex VPrt constructions (in which the particle is associated with an additional PP) and tries to solve the puzzle of why there is a preference for the RPrt word order over the LPrt order in these cases, which is the reverse of the preference pattern with the ordinary "bare" particle. In 4.4, I also discuss complex phrasal particles (cf. section 2.3.2). Section 4.5 includes a Mainland Scandinavian micro-comparison, where I especially focus on Swedish contra Norwegian. In 4.6, I suggest an alternative where the Norwegian particle alternation could be the result of parallel grammars, i.e., that the LPrt distribution represents the proper spoken Norwegian grammar, while the RPrt distribution is the result of the diachronic Danish influence on the Norwegian written standards. Section 4.7 concludes the chapter.

4.1 The Basic Order

4.1.1 *Prt-DP* vs. *DP-Prt*

As Áfarli (1985: 75) points out, there are in principle two ways of deriving (2a) from a *Prt-DP* base order, and similarly two ways of deriving (2b) from a *DP-Prt* base order.

- (2)
- a. Jon sparka hunden ut.
'John kicked the dog out'
 - i. Jon sparka hunden_i ut t_i.
 - ii. Jon sparka t_i hunden ut_i.

 - b. Jon sparka ut hunden.
'John kicked out the dog'
 - i. Jon sparka ut_i hunden t_i.
 - ii. Jon sparka t_i ut hunden_i.

From a *Prt-DP* order, (2a) can be derived by DP movement to the left (2a_i) or particle movement to the right (2a_{ii}). From a *DP-Prt* order, (2b) can be derived by moving the particle to the left (2b_i) or the DP to the right (2b_{ii}). In addition to this, it is possible that there exist derivations that do not affect the actual word order. Thus, we have seen den Dikken's (1995)

proposal to derive LPrt constructions from the Prt–DP base order by stipulating abstract incorporation of the particle into V (see section 3.3). Similarly, another method of deriving RPrt constructions from the DP–Prt base order without affecting the word order is suggested by Svenonius (1996a). He argues for EPP-driven movement of the DP into a functional layer above the SC (see section 3.4).

I assume that downward movement is generally excluded, due to a requirement that a trace/copy must be c-commanded by its antecedent. Let us repeat the definition of c-command from chapter 1, as formulated in Chomsky (1995: 35):

(3) α c-commands β if α does not dominate β and every γ that dominates α dominates β .

In a binding relation, e.g. a trace must be c-commanded by its antecedent, e.g., as shown in (4a). Downward movement of the antecedent so that the trace is no longer in the antecedent’s c-command domain yields the ungrammatical structure in (4b).

(4) a. [Johan_i [vart sett t_i]]

John_j was seen t_i

‘John was seen’

b. *[t_i [arbeider Johan_i]]

t_i works John_i

‘John is working’

Hence, independently of the base order we adopt, we are forced to assume upward DP movement and/or upward particle movement to derive RPrt and LPrt constructions.¹⁰⁰ In Minimalist terms, this fact is also covered by the Extension Condition (Chomsky 1995: 327), which guarantees cyclicity in the sense that the merge/remerge operation only applies to a root syntactic object, i.e., “a syntactic tree that is not dominated by any syntactic object” (Hornstein et al. 2005: 62). In (5) below, that means that a new syntactic object must merge with the PP (which is not dominated by any syntactic object), and not, e.g., with DP_i (which is dominated by PP).

¹⁰⁰ As mentioned in section 3.3.3, Kayne (1985) derives LPrt constructions (2b) using DP adjunction to the right, i.e., through heavy DP shift. I refer the reader to Svenonius (1992) and den Dikken (1995: 87) for reasons to reject this alternative. However, we will see later that some VPrt constructions might have a focus-shifted DP.

The simplest and most economical way to derive the RPrt and LPrt word orders seems to be the one proposed by Taraldsen (1983) (cf. section 3.1). Taraldsen assumes a Prt–DP base order and leftward DP movement into the subject position of the particle:¹⁰¹

(5) the dog_i out t_i

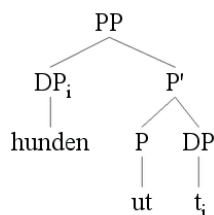

The alternation is described with a single movement, and there is no need to generate new structure for the landing site of the DP, since the specifier of PP is already provided by X' principles.

However, in section 3.1 we saw that there were several empirical and conceptual problems with Taraldsen's analysis, some of them being due to the basic order he assumes. (5) implies that P and DP form a constituent, and P and DP should therefore be able to topicalise as one unit, as the result of an A' movement of P' or PP. On the other hand, *ut* 'out' alone should not be able to topicalise, given this analysis. However, the facts run exactly contrary to these predictions. The examples in (6) are repeated from section 3.1, and they are originally taken from Taraldsen (1983: 250).

(6) a. Ut slipper vi ikke den hunden.
 out let we not that dog
 'We won't let that dog out'

b. *Ut den hunden slipper vi ikke.
 out that dog let we not
 'We won't let that dog out'

Obviously, *ut den hunden* 'out that dog' does not behave like a constituent, and therefore Taraldsen needs an extra reanalysis device to account for the failure of (6b).¹⁰² Also, the

¹⁰¹ I use the DP notation here, although Taraldsen's work predates Abney's (1987) DP hypothesis.

grammaticality of (6a) remains a mystery.¹⁰³ In Taraldsen's system, the DP must move, followed by topicalisation of P' (i.e., P + the DP trace), but movement of constituents containing traces was not a standard option in 1983.

In the previous chapter, I discussed analyses proposed in seven different works (see the summary in section 3.7). In the present chapter, I will argue that the DP–Prt base order is the one that should be adopted, as also proposed by, e.g., Áfarli (1985), Svenonius (1996a), Ramchand & Svenonius (2002), and Ramchand (2008). Assuming this base order, I will account for the particle alternation with only one movement, namely leftward movement of the particle. However, this alternative is less minimal than Taraldsen's alternative illustrated in (5), since we need an extra projection to provide a landing site for the particle. This is illustrated in (7), where the extra projection in question is called X(P).

(7) out_i the dog t_i

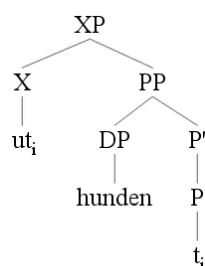

Despite the extra projection, I will argue that (7) is superior to (5) in other important respects. For instance, (6a) can be accounted for straightforwardly if we assume that P' has A'-moved to the topic position (hence (6a) contains no ordinary particle movement to X). Note that this presupposes topicalisation of bar levels, and hence treats them as maximal projections.¹⁰⁴ If we accept this, (7) can handle (6a) with no extra devices or stipulations. Still, a potential drawback to the structure in (7) is that since XP is a constituent, we expect that it could be

¹⁰² Basically, P is reanalysed as a particle and exempted from being a Case assigner, so *hunden* 'the dog' fails to receive Case in the topicalised position. See the discussion in section 3.1.3.

¹⁰³ Particle extraction is felicitous only in directional constructions, and not when the construction has a metaphorical reading:

- (i) *Ut las han ikkje den boka
out read he not that book
'He didn't finish that book'
- (ii) *Ut rekna han ikkje prisane
out calculated he not the prices
'He didn't calculate the prices'

In section 4.3.6, I will suggest an analysis that assumes a structural difference between directional and metaphorical constructions.

¹⁰⁴ This in turn is actually an argument in favour of Bare Phrase Structure (cf. section 1.2.1), because the bar-level will also be annotated as PP, and therefore be treated automatically as a maximal projection.

topicalised, which would yield the ungrammatical structure in (6b). However, topicalising XP would also require moving the trace of the particle, and could therefore fail if we do not adopt remnant movement. But remnant movement is possible in other cases, e.g., when a passive sentence, with its internal movement, is topicalised: [*At Johan_i vart sett t_i]_j, *trudde ingen på t_i*. ([that John_i was seen t_i]_j, believed no one on t_j ‘No one believed that John was seen’). Therefore, I will assume that the impossibility of topicalising XP in (7) is rather due to the functional status of the X-projection (see section 4.2.1).*

There are also additional arguments that favour (7) over (5) and give us reason to believe that head (particle) movement is involved at some stage. Ramchand & Svenonius (2002: 8f) put forward evidence from English VPrt constructions modified by *right*, and this evidence can be reproduced for Norwegian constructions modified by *rett*. Consider (8), which is repeated from section 3.6.4.

- (8) a. Vi kasta hunden rett ut.
we threw the dog right out
- b. *Vi kasta hunden ut rett.
we threw the dog out right
- c. *Vi kasta rett ut hunden.
we threw right out the dog
‘We threw the dog right out’

If we adopt Taraldsen’s approach in (5) and assume P_{rt}–DP to be the base order, so that (8c) corresponds to the basic order here, then the DP must obligatorily move across the Deg–P_{rt} complex to derive (8a). The problem is that it is not clear what independent motivation exists for this obligatory movement. From (1a) above, we know that P_{rt}–DP is the preferred surface order in Norwegian. Given (5), the preferred word order is derived with no overt movement at all, but as soon as *rett* is inserted, DP movement becomes obligatory.

If we instead assume DP–P_{rt} as the base order, as in (7), all the three examples in (8) are explained naturally through (restrictions on) head movement, as discussed in section 3.6.4. (8b) crashes because Deg blocks the particle movement across it,¹⁰⁵ and (8c) also fails

¹⁰⁵ At least given that Deg heads its own projection, cf. the discussion in 3.3.5.

because two heads cannot move together (as there is only one landing site for them, cf. also Ramchand & Svenonius 2002: 9).

If we adopt (7), we maintain a causative representation of the particle construction (Svenonius 1996a), in which the SC predicate is caused by the matrix V. This facilitates a parallel analysis of standard and complex constructions. (9a) is the basic representation of a complex particle construction corresponding to (5) above, and (9b) is the basic representation corresponding to (7).

- (9) a. Johan kasta [ut hunden i hagen]
 ‘John threw out the dog in the garden’
- b. Johan kasta [hunden ut i hagen]
 ‘John threw the dog out in the garden’

Only in (9b) is *i hagen* ‘in the garden’ analysed as the complement of *ut* ‘out’, while in (9a), *hunden* ‘the dog’ is the complement of *ut*. (9a) also corresponds to den Dikken’s (1995) basic order; in section 3.3.4, I argued extensively against his analysis of the particle as ergative, i.e., that it lacks an external argument. I showed with syntactic tests that the hypothesis fails, and thus I claim that the basic structure in (9a) cannot be correct. I consider the analysis indicated in (9b) to be the intuitively correct one, i.e., that *hunden* ‘the dog’ is a subject in a small clause. I claim that the particle is predicational, that it has a subject, and that it can take a resultative PP complement. (9a) is not well motivated; instead, (9b) captures the nature of the particle in a more intuitive manner.

4.1.2 Some General Notes on the Complexity of the Derivation

I will end this section with some general notes concerning the derivations that are presupposed within the framework that we adopt. Obviously, the abolition of government in Minimalism has consequences for the complexity of the derivation of VPrt constructions. In GB theory, Accusative Case was typically assumed to be assigned by government. Consider Chomsky’s (1986: 15) definition of government:

- (10) α θ -governs β iff α is a zero-level category that θ -marks β , and α, β are sisters.

Now, if we further assume that Case on the DP in VPrt constructions is associated with V, independently of the surface location of the particle (cf. Ramchand & Svenonius 2002: 4, Sandøy 1976: 103, and the discussion in section 3.6.3), then the DP must find itself in the governing domain of V in order to get Case. Usually, that means that it must be V's complement or the specifier of V's complement. If the DP is generated beyond the governing domain of V, like in Taraldsen's (1983) or den Dikken's (1995) analyses, it must move in order to get Case by V, as shown in (11).

(11)

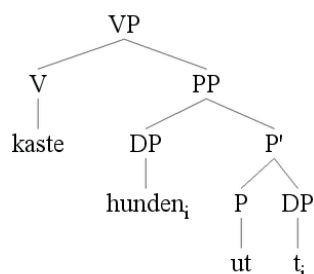

Both Taraldsen (1983) and den Dikken (1995) motivate the movements they assume by appealing to Case requirements. In their analyses, the DP must move into the governing domain of V. Taraldsen's RPrt derivation looks much like (11). Likewise, from the same Prt-DP base order, den Dikken derives RPrt constructions by assuming leftward DP movement into the θ' subject position of the particle-headed SC. LPrt constructions are derived by assuming abstract particle incorporation into V so the *in situ* DP can receive Case through the Government Transparency Corollary (see section 3.3.2).

However, in newer versions of Minimalism, Case assignment is not dependent on adjacency between the assigner and the assignee. As mentioned in section 1.2.1, the standard assumption since Chomsky (2000, 2001) has been that Case is licensed by a probe-goal relation between a head and a DP. The following quote is repeated from 1.2.1:

A probe is a head with [-interpretable] features and a goal is an element with matching [+interpretable] features. In order to have its [-interpretable] features deleted for LF purposes and specified for morphological purposes, a given probe peruses its c-command domain in search for a goal. A goal is accessible to a given probe only if there is no intervening element with the relevant set of features; that is, relativized minimality holds (Hornstein et al. 2005: 317).

In (11), we assume that V has [-interpretable] (i.e. unvalued) Case features that need to be valued or deleted. V then *probes* its c-command domain (cf. (3)) in search of an element with matching [+interpretable] Case features, and in this way its own Case features get valued.¹⁰⁶ Since DPs can have Case morphologically realised, we can assume that a [+interpretable] Case feature is found on them. Hence, the closest DP (cf. Relativised Minimality) will be the goal for V's Case probe and the element that matches and values V's Case features. Note that in (11), the base position of the DP is found within V's c-command domain. This means that DP movement for Case reasons should be unnecessary in VPrt constructions. Whether we assume Prt–DP or DP–Prt as basic order, the DP will get Case in its base position, given that Case is licensed in a probe–goal fashion. This allows us to suggest a generally simpler structure, or at least assume fewer movements, than the GB and early MP approaches.

4.2 The Structure of VPrt Constructions

4.2.1 The Particle Lexicalising a Dynamic Node

By adopting DP–Prt base order and claiming that DP movement for Case reasons is unnecessary and hence barred, we are able to derive LPrt constructions through head movement, cf. (7).¹⁰⁷ For Ramchand (2008) (cf. section 3.6.6), the particle obligatorily moves to a resultative node to check result state, and for Ramchand & Svenonius (2002) (cf. section 3.6.2), the particle moves only in the LPrt cases. I repeat an essential outline of the two analyses here:

(12)

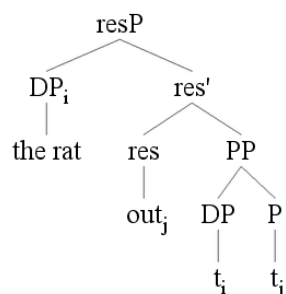

¹⁰⁶ In some sense, this actually seems counter-intuitive, i.e., that the verb *gets* Case by being valued, cf. the traditional idea that the verb *assigns* Case.

¹⁰⁷ Some possible problems with head movement are discussed in section 1.2.1.

What the two similar analyses have in common is an optional DP movement to Spec, resP. For Ramchand & Svenonius (2002), the DP moves if the particle does not move (i.e., to check the result state when the particle does not). By assuming obligatory particle movement, Ramchand (2008) is forced to stipulate a second and optional DP movement in order for RPrt constructions to be derived. I have already mentioned that I find the 2002 solution the more attractive of the two, since in my opinion the second movement of Ramchand (2008) is not well motivated.

Again, there are basically two word orders to explain. Let us assume that those two orders are explained by one, and only one, possible movement. (13) is then the most economical way of accounting for the particle alternation:

- (13) Head movement of the particle is the only possible movement in VPrt constructions.¹⁰⁸

Following Fraser (1976), Kayne (1985), Aarts (1989), Svenonius (1996a), VPrt constructions are resultatives; a result state is denoted by the DP + particle SC, and it is caused by V. The basic structure can thus be given the rough representation in (14), where the particle heads the SC, and the DP is generated in the subject position of the SC. This is a common way of representing VPrt constructions, if we take their resultative nature to be essential.

- (14) Vi kasta ...

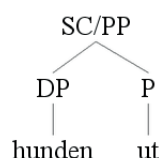

‘We threw the dog out’

With the basic structure of (14), we must account for a landing site for the particle above the SC, as already shown in (7). Uncontroversially, Svenonius (1996a) postulates a functional layer on top of the SC, and assumes that particle movement to that functional domain is EPP-driven. Svenonius (1994, 1996b) represents the SC with Bowers’ (1993) predication operator,

¹⁰⁸ This rule will be modified further below. In unaccusative VPrt constructions, I will argue that the DP can move directly to the matrix, but that it is not provided a landing site within the particle SC. Apparently, short phrases can be construed as particles too: *ta av seg hatten* ‘take off REFL the hat’ (see 2.3.2 and 4.4.2).

and assumes that the particle can move to the head of the predication projection to lexicalise that node.¹⁰⁹ For Ramchand & Svenonius (2002) and Ramchand (2008), the particle movement is motivated to identify result state within the decomposed verbal structure, cf. (12). But whether the particle moves or the DP, or both, does not affect the meaning of the structure, which is considered “equally” resultative in either case. This result is, as mentioned several times, problematic.¹¹⁰

In light of (1a, b), there is reason to believe that particle movement is associated with a change of meaning. So, let us now assume that particle movement is triggered by a semantic property X which projects in a functional domain between V and the SC. I assume that X is responsible for (1b), i.e., the fact that the meaning of the LPrt construction differs from that of the RPrt construction:

(15)

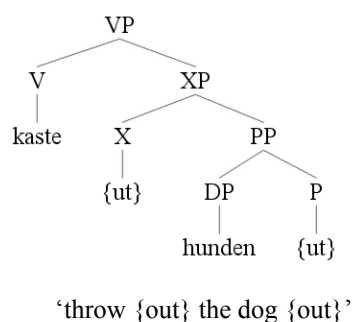

Hunden ‘the dog’ remains in the subject position, getting its relevant Case- and phi-features valued in a standard a probe–goal fashion, as discussed in section 4.1.

Now, the important questions posed by (15) are: 1) What is X, 2) why does it trigger particle movement, and 3) why is this movement preferred over no movement? Following Sandøy’s (1976: 103) description of the Romsdal dialect, directional RPrt constructions usually emphasise the meaning of the particle, i.e., direction. Interestingly, non-directional constructions cannot have the particle right-handed, apparently because there is no direction to emphasise. In metaphorical constructions, the particle also seems to be more closely

¹⁰⁹ In section 4.3.3, we will return to Bowers’ model in light of Áfarli’s (2007) syntactico-semantic frames. It is fully possible to integrate Bowers’ model into our model here, but it is not a decisive factor for the discussion. I will therefore not specify it explicitly.

¹¹⁰ Also keep in mind Taraldsen’s (1983) analysis, in which only RPrt constructions are predicational (cf. section 3.1)

connected to the verb, and in many cases it cannot easily be replaced by a different particle.¹¹¹
 In (16), a Romsdal Norwegian example from section 2.1 is repeated:

- (16) a. *rekne ut prisan*
 calculate out the prices
 ‘calculate the prices’

b.

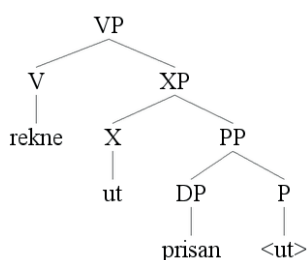

Obligatory Prt movement

In idiom-like expressions, in which LPrt is obligatory for some speakers and certainly preferred by most, the particle will move (more or less) obligatorily to X in the structure in (15). Sandøy (1976: 107f) provides some similar metaphorical examples with left-bound particles. All judgements are from Romsdal Norwegian.

- (17) a. *å måle {opp} gard'n {*opp}*
 to measure {up} the farm {up}
 ‘to measure the size of the farm’

- b. *Han ha plikt te å låne {ut} varå {*ut}*
 he has duty to lend {out} goods {out}
 ‘He is obliged to lend out the goods’

¹¹¹ However, the verb *rekne* ‘calculate’ can have metaphorical combinations with both *inn* ‘in’ and *opp* ‘up’ (see also section 4.3.6). Vinka (1999: 345) notes another difference: In a non-predicative VPrt construction (which corresponds to a metaphorical construction here), the main verb cannot be replaced by the light verb *ha* ‘have’, which is possible in predicative (directional) constructions.

- c. Han he rekna {ut} prisan {*ut}
 he has calculated {out} the prices {out}
 ‘He calculated the prices’
- d. ... korleis me laga {te} mat {*te}
 ... how we made {to} food {to}
 ‘... how we prepared the food’
- e. Han las {opp} brevet {*opp}
 he read {up} the letter {up}
 ‘He read the letter loudly’

Den Dikken (1995: 92f) claims that idioms with fixed objects typically have obligatory LPrt, as opposed to idioms with non-fixed objects, which have obligatory RPrt. But regarding (17), we must assume that the particle is obligatorily spelled out in X. This means that in metaphorical constructions, the particle is more closely connected to the verb than in concrete, directional (resultative) constructions. The particle seems to unify with V, and V and the adjacent particle constitute a dynamic unit somehow. In (15), the dog becomes “out” as a result of the throwing, but the farm in (17a) certainly does not become “up” as a result of the measuring. Likewise, the prices in (17c) do not become “out,” and the letter in (17e) is not “up” as a result of the reading (cf. also Aarts 1989: 280). These constructions are hardly resultative, and we can account for that fact by assuming obligatory particle movement to X, so that the particle becomes verb-adjacent. I will return to the (quasi-)idiomatic constructions in section 4.3.2 and discuss them in light of Bruening’s (2010) approach to idiom formation. I will also return to how the different derivations of directional and metaphorical constructions can be formalised.

I argued in section 3.5.4 that Zeller (2001) is wrong in assuming LPrt to be reanalysed as part of V, because an adverb may occur between V and the particle. (18) (from Áfarli 1985) shows that the particle is structurally independent of V; even though it is usually adjacent to the verb in LPrt constructions, V-movement to C nevertheless takes place *without* the particle being moved along with V.

- (18) a. Kari sparka heldigvis ut hunden.
 Kari kicked luckily out the dog
 ‘Kari luckily kicked out the dog’
- b. *Kari sparka ut heldigvis hunden.
 Kari kicked out luckily the dog
 ‘Kari luckily kicked out the dog’

Hence, it is reasonable to assume that there is a functional head adjacent to V, namely X, that explains the independent status of the particle, and the particle cannot be a structural part of V.

Since X is active in LPrt constructions, and since it allows the particle to create a dynamic unit with the verb, let us refer to X as *Dyn(amic)*. With X understood as Dyn, I will further assume that it is reserved for particles. Until further notice, before we have any possible empirical counterevidence, let us assume that DynP is structurally defective, in the sense that Dyn does not license a specifier. Dyn is a semantic property that triggers particle movement only. The structure gets the dynamic reading when this property is lexicalised by the particle. I assume that the particle moves to identify Dyn in a manner similar to the way it moves to identify result state in Ramchand & Svenonius (2002) and Ramchand (2008) (cf. section 3.6 above). The syntactic process is the same, but the semantic motivation is a different one.

From now on, I adopt (19) as the basic representation of Norwegian VPrt constructions. X in (15) and (16b) = Dyn, and the complement of Dyn can represent various SC categories (although PP is the most common one).¹¹²

¹¹² As already mentioned, I am agnostic about the existence of a PrP (Bowers 1993) in the SC-PP, see sections 4.3.3 and 5.2.2 below.

(19)

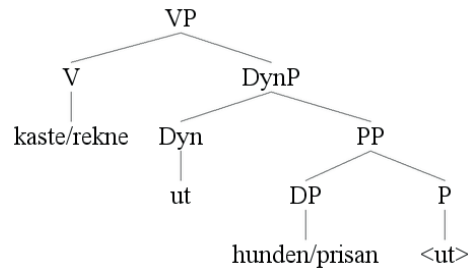

throw/calculate out the dog/the prices <out>
'throw out the dog', 'calculate the prices'

In the following sections, I will see how (19) matches the Norwegian data given in chapter 2. The empirical generalisations that will be discussed can be found in section 2.7. In (20), three of the generalisations are repeated, summing up chapter 4 so far.

- (20)
- a. LPrt and RPrt are not distributed optionally in Norwegian; LPrt is generally (and by most speakers, *clearly*) preferred.
 - b. The meaning of a given LPrt construction is different from that of the corresponding RPrt construction.
 - c. Metaphorical VPrt constructions are even more LPrt-bound than directional constructions.

4.2.2 *The Particle Lexicalising Proc?*

Before we look at the data, let us briefly see whether it is possible to adapt (19) to be compatible with the model developed by Ramchand (2008). I concluded in section 3.6 that Ramchand & Svenonius' (2002) model cannot account for the differences in preference and meaning among Norwegian particle constructions, given that particle movement is motivated by lexicalisation of result state. Ramchand & Svenonius (2002: 7) give an example in which the DP is both the undergoer of the verbal action and the holder of the abstract result state. (21) is repeated from section 3.6.2:

| | | | |
|------|-------|----------------------------|-----|
| (21) | Throw | the dead rat | out |
| | V | Undergoer/Holder of Result | Prt |

As we saw earlier, Ramchand & Svenonius (2002) further argue that the DP must be merged in Spec,PrTP, and that it moves to Spec,resP (if the particle does not move). In the present section, I have argued that the position of LPrt must be higher, and a natural suggestion would be that its position is in V (as assumed by Ramchand & Svenonius 2002), or in proc (as assumed by Ramchand 2008). However, V/proc is the position where the main verb is usually merged (cf. *hand* in the structure below), which will block any particle movement from, e.g., res to proc, unless we accept an incorporation analysis (cf. Ramchand & Svenonius 2002: 8). Also, as we have seen above, that would force us to stipulate some kind of excorporation mechanism in V2 contexts. The following structure is taken from Ramchand (2008: 132):

(22)

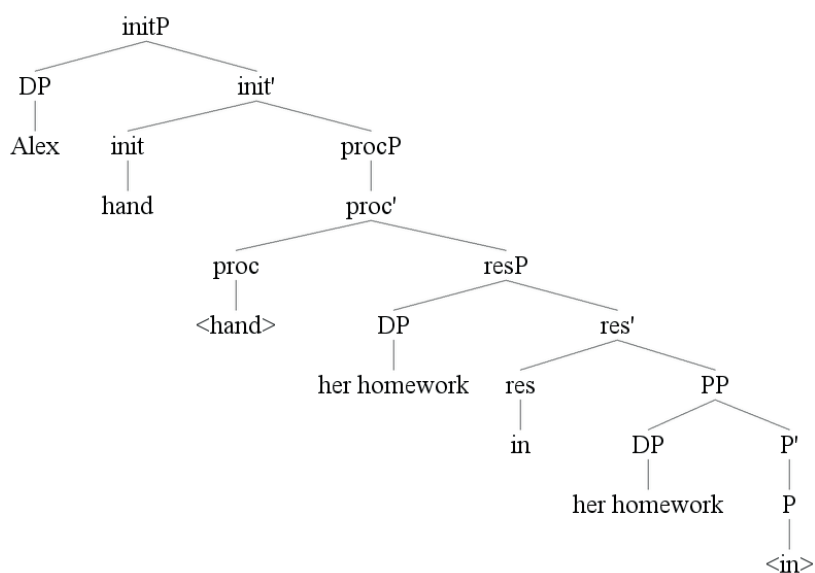

In this representation, particle movement to res is obligatory, while DP shift is optional. Semantically, proc is well suited as the position for LPrt, but it is not compatible with a non-incorporation analysis. The similarity between Ramchand & Svenonius' (2002) and Ramchand's (2008) analyses and mine is that there is a functional domain between the base position of the main verb and that of the particle, and the particle can move into that domain. Whereas Svenonius and Ramchand claim that the particle moves to a res-like position, as in (22), I claim that it moves *from* a res-like position to a proc-like position, as in (19). I will

continue to call this proc-like position Dyn, and I thus avoid the problems that arise if we allow incorporation.

Notice also that the head position of the resultative PP is a resultative position itself, so moving the particle to identify result state seems redundant and therefore excluded. Instead of having two res-like positions, we could wish for two proc-like positions, because Dyn must be semantically comparable to proc. But since the verb is merged in proc in (22), there is no proc-like position available for the particle.

4.3 The Derivation of Directional and Metaphorical VPrt Constructions

4.3.1 Structural Semantics, Lexical Semantics, and World Knowledge

In section 1.2.2, I presented a brief discussion of syntactic frame models (cf. Borer 2005) and models that assume that the *structure* is a primary carrier of meaning (cf. Áfarli 2007, Lohndal 2012, 2014, Marantz 2013, and Nygård 2013). I will now show evidence from VPrt constructions that supports these theories. A given structure can be modified by the semantics of the lexical elements (e.g., by the verb, the particle, and the DP), and further by general world knowledge or *situational semantic* factors (cf. Bouchard 1995: 17). For the final interpretation of a sentence, I consider the following three levels crucial, with (23i) being primary, (23ii) secondary, and (23iii) tertiary.

- (23) The full interpretation of a structure depends on the three following factors in the given ranked order:
- i. The semantics of the structure
 - ii. The semantics of the lexical elements
 - iii. The general non-linguistic situational semantics (e.g. world knowledge)

In what follows, I will first discuss the semantics and derivation of the VPrt *structure* in section 4.3.2, then the derivation of the LPrt and RPrt structure in section 4.3.3, and the semantics of the lexical elements (i.e., prepositions) in section 4.3.4. In section 4.3.5, I will discuss (23iii), or more generally the S-semantic contribution to the final interpretation of a particle construction. In section 4.3.6, I suggest that there are two structurally different LPrt constructions, one predicational and one non-predicational. In sections 4.3.7–4.3.8, I continue

to question the subject status of the theme DP in LPrt constructions, and conclude that all LPrt constructions have weakened the predication and hence have devalued the subject status of the DP. My main goal in section 4.3 is to show that (23i) is primary, but nevertheless the semantics of the structure can be modified and also apparently contradicted by the factors mentioned in (23ii, iii).

4.3.2 *The Structure as the Primary Carrier of Meaning*

We will now see that the distribution of the particle triggers a certain reading of the VPrt construction. More concretely, I will explore the semantic consequences of the lexicalisation of Dyn. We have postulated that particle shift is semantically motivated and that the consequence is a “dynamised” structure. If particle movement is associated with a change in meaning somehow, we should expect minimal pairs with different readings, on the basis of the particle distribution alone. As shown in (24), this expectation seems to be borne out. These two examples have identical lexical elements but different preferred readings, at least when we take their most conventional interpretations into account:

- (24) a. Få pakken opp
 get the packet up
 ‘Bring the packet up’ (directional reading)
- b. Få opp pakken
 get up the packet
 ‘Open the packet’ (metaphorical, aspectual reading)

Since the lexical elements are identical in (24a) and (24b), I suggest that the semantic difference must be provided by the structure, and that DynP plays a crucial role in the explanation of this difference. The RPrt construction (24a) has a concrete, directional reading. In contrast, the LPrt order (24b) gives the structure a more abstract and aspectual reading. I will discuss prepositional semantics more thoroughly in section 4.3.4; for the time being, I assume that *opp* ‘up’ has a basic directional reading, i.e., denoting a movement from a lower to a higher level. Given that the RPrt construction in (24a) has a resultative interpretation, the semantics of *opp* can be said to be compatible or in harmony with its RPrt position in the

structure. With the particle in the left-hand position, cf. (24b), the directionality is no longer emphasised.

I suggested in section 4.2.1 that the LPrt somehow creates a dynamic unit with the verb, and that a “loss” of the directionality reading then follows. But in section 2.1.2, we saw that almost 50 % of the LPrt constructions in the Nordic Dialect Corpus (Johannessen et al. 2009) were in fact directional. This means that the lexicalisation of Dyn and the creation of the dynamic unit does not necessarily bring about an unequivocal metaphorical reading of the structure. That is also seen in this much-discussed example pair:

- (25) a. Johan kasta hunden ut
 ‘John threw the dog out’
- b. Johan kasta ut hunden
 ‘John threw out the dog’

Although (25b) presumably has a directional reading as well, I will continue to argue that V + LPrt create a dynamic unit here too. This example shows the contribution and importance of the specific lexical elements more clearly than (24b). While *få* ‘get’ in (24b) does not denote a specific action or direction, the lexical semantics of *kasta* ‘threw’ in (25b) strongly favour a directional interpretation. In both (24b) and (25b), the semantic value of the structural Dyn head is lexicalised, but while the former example only has one directional lexical element (*opp* ‘up’), the latter has two (*kaste* ‘throw’, *ut* ‘out’). In the latter example, the lexical semantics thus seems capable of overriding the primary structural semantics, while the semantic value of Dyn “wins” in (24b), at least in the default case. In section 1.1.2, I claimed that given the right context, (24b) can also have the directional reading.¹¹³ And opposite, (24a) can marginally have a metaphorical reading (say, if someone orders *Få pakken opp!* ‘open the packet’ to a slow gift-opener on Christmas eve). However, the alternative metaphorical/aspectual reading of (24a) is less accessible (i.e., more marginal) than the

¹¹³ From section 1.1.2:

A: Vil du sjå på pakken her nede?
will you look on the packet here down?
‘Do you want to look at the packet down here?’
B: Nei, få opp pakken.
no, get up the packet
‘No, get the packet up here’

alternative directional reading of (24b).¹¹⁴ I think this is because (24a) has two resultative elements (the SC structure and *opp* ‘up’), while (24b) has one resultative element (*opp*) and one non-resultative element (the DynP structure). Because of the “harmony” between the structural semantics and relevant lexical semantics in (24a), this is harder to override by the third factor (the context). But when there is “conflict” between the structural and the relevant lexical semantics, as in (24b), the final interpretation is more dependent on the third factor.

In every construction, there is an interaction between the structural and lexical semantics. In some cases there is harmony between the two levels, and in others there is more friction.¹¹⁵ This interaction (and the general conceptual semantics, cf. (23iii)) determines the final interpretation of the construction. I will return to the lexical modification of the structure in section 4.3.4.

It can now be seen more clearly that the creation of a dynamic V + LPrT unit is similar to Svenonius’ (1996a) and Pesetsky’s (1995) notion of *l(lexical)-selection* (cf. 3.4.2). L-selection is the “selection of a particular lexical item, typically a preposition by a verb” (Svenonius 1996a: 5). Svenonius considers l-selection a prerequisite for particle shift to take place. I suggest that the creation of the dynamic unit is structurally founded, since it is a direct consequence of lexical insertion in Dyn. DynP can only be selected by V, and their tight connection in many cases (i.e., the metaphorical constructions) yields an interpretation of V and Dyn as if they were *one* lexical item.¹¹⁶ That is, they are always structurally separate, but the fact that metaphorical V + LPrT pairs can be replaced by a single verb, see (26), shows the effect of the tight structural relation between V and Dyn; it is as if they were one lexical item. I hold the *G(rammar)-semantics* (i.e., the semantics that is linguistically relevant, cf. Bouchard 1995: 17) of Dyn responsible for this reading,¹¹⁷ so apparent “l-selection” is technically V’s selection of this particular functional category. Whatever lexical element is inserted in that functional category can in principle get the “lexicalised” interpretation with V. This could be considered a structural-semantic version of “l-selection”.

¹¹⁴ These kinds of semantic nuances are not easy to elicit, neither orally nor in a written scheme. I have discussed (24a, b) with three speakers of *Trøndsk*, who all had basically the same intuitions as my West Norwegian intuition, but I have not made a bigger empirical research. However, the indications I have got seem to be quite clear.

¹¹⁵ Cf. also the discussion in section 1.2.2. I will use the term *friction* or *mismatch* when the semantics of the structure and the basic semantics of a lexical item are apparently contradictory. In cases with less contradiction, as in (25a), I will use the term *harmony*.

¹¹⁶ In chapter 5 (section 5.2.2), I will argue that this effect is also present in directional LPrT constructions, i.e., that the “activation” of Dyn always yields the appearance of V + Prt being lexicalised.

¹¹⁷ I will discuss Bouchard’s categories of G- and S(ituational) semantics more thoroughly in section 4.3.4.

- (26) a. få opp pakken → opne
 get up the packet → open
 ‘bring up the packet’
- b. lukke opp døra → opne
 lock up the door → open
 ‘open the door’
- c. leggje ned bedrifta → stengje
 lay down the business → close, end
 ‘close the business’
- d. samle inn pengar → samle
 collect in money → collect
 ‘collect money’
- e. leggje opp midlar → spare
 lay up funds → save
 ‘save funds’

Bruening (2010: 531ff) argues that idioms are formed by selection of a lexical category, i.e., that the interpretation of a lexical category as idiomatic depends on it being selected. This could be a formal way of distinguishing between directional and non-directional LPrT constructions. Bruening presupposes that the selected element must be a lexical category in order to have the idiomatic interpretation. My suggestion that the LPrT heads a functional category, DynP, should be compatible with Bruening’s hypothesis because DynP is always headed by a lexical element (usually P or A), and not, e.g., an affix. If we assume that this selection is what separates the directional from the metaphorical examples, then the difference is accounted for with one extra “selection device.” In section 4.3.6, I will suggest that directional and metaphorical LPrT constructions can be structurally distinguished in a way that can account for empirical facts about general idiom formation (cf. Marantz 1984, 1997 and Bruening 2010). Aarts (1989) and Vinka (1999) also argue for structurally different representations for predicative and idiomatic (non-predicative) VPrT constructions.

4.3.3 Particle Movement or Lexical Insertion in VPrt Frames?

There are in principle two ways to construe the structural difference between LPrt and RPrt constructions and the lexicalisation of Dyn. Until now, I have been faithful to the traditional generative particle literature and assumed that particle movement either takes place or does not take place given a basic structure. I have assumed that the two constructions have the same underlying X-bar structure, and that they differ with regard to the following rule: *move the particle to Dyn*. I will call this *the derivational construal*. The alternative construal is to assume that LPrt and RPrt constructions actually differ with regard to their basic X-bar structure, and that DynP is generated only in the LPrt construction. I will call this *the representational construal*.¹¹⁸

I will now try to defend the representational construal. In the structures below, I show the derivational construal in (27), and the representational construal in (28). The latter is represented with two different *frames*, which I will relate to Áfarli (2007) and to Borer's (2005) *templates* further below (cf. also section 1.2.2).

(27) **Derivational construal (the particle moves/remerges)**

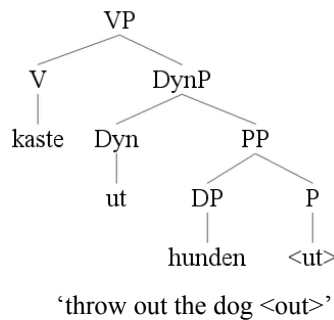

¹¹⁸ Further below, we will see that this discussion can be directly related to the analysis of double object constructions.

(28) **Representational construal**

a. RPrT frame (resultative meaning):

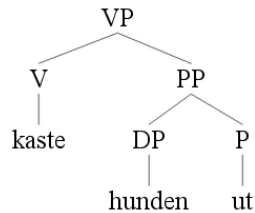

'throw the dog out'

b. LPrT frame (dynamic meaning):

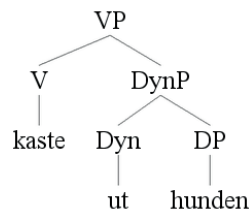

'throw out the dog'

The representational construal and the structural difference displayed in (28) force an analysis of the RPrT vs. LPrT alternation that is radically different from what I have discussed so far within the derivational construal. Note that each of the structures in (28) are more minimal than the structure in (27), which presupposes DynP even when it is not identified, and which presupposes movement (or internal merge) and thus an empty category (a copy) in the basic particle position. In (28a), DynP is not generated, and the VP takes a SC complement. In (28b), Dyn is generated, and assuming Dyn to be reserved for particles, we may assume that *ut* 'out' is directly inserted into that head position. Crucially, and as shown in (28b), DynP now takes a simple DP complement and not a SC.

Assuming a frame-based derivational approach, it is in principle possible to assume both (27) and (28b) to be possible LPrT frames, and thus that Dyn is lexicalised by movement in (27), but by direct insertion in (28b). A similar movement vs. insertion option is found in the analysis proposed in Bowers (1993). In Bowers' account, a *predication operator* (Pr) heads a PrP, and it is assumed that the verb moves to the Pr head; see (29a). In other instances

Pr is assumed to be lexicalised by direct insertion. This is the case for so-called *som*-predicatives, in which *som* is directly inserted in Pr (like English *as*) (cf. Eide & Åfarli 1999); see (29b).

(29) a.

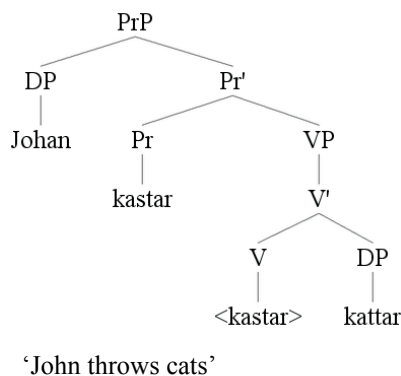

b. Dei vurderer ...

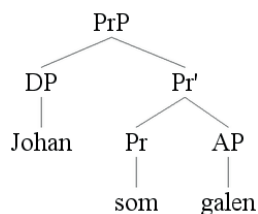

'They consider John (to be) crazy'

There is a similar theoretical option regarding the LPrt frame. Still, I will tentatively argue that assuming just (28b) for the LPrt construction is the more appropriate solution, not least because it is more economical.

It is also reasonable to assume that DynP can take different types of categories as a complement, just as VP does. In chapter 5 (section 5.2), we will take a closer look at unaccusative VPrt constructions, but let us consider impersonal meteorological constructions already at this stage. Weather predicates typically have no arguments (Chomsky 1981: 27); in Norwegian they need an expletive to fulfil the subject requirement. However, when they combine with a particle, they can also take a DP or a resultative PP. In the two following structures, RPrt is generally impossible:

- (30) a. Det bles {opp} ein storm {*opp}.
 it blew {up} a storm {*up}
 'A storm started'
- b. Det bles {opp} til storm {*opp}.
 it blew {up} to storm {*up}
 'It increased to storm level'

Since RPrT is unavailable, the most economical way of representing these two structures is presumably by assuming direct insertion of *opp* 'up' in Dyn. Then Dyn takes a DP as its complement in (30a), corresponding to (31a), but a resultative PP in (30b), corresponding to (31b):

- (31) a. Det bles [_{DynP} opp [_{DP} ein storm]].
 b. Det bles [_{DynP} opp [_{PP} til storm]].

Given this analysis, one may ask whether Dyn can take SC complements at all. It seems that it can. In (32a), *lauv på taket* 'leaves on the roof' is a typical resultative prepositional SC. Interestingly, the SC can be extended with another *opp* 'up' as well, as in (32b). Note that the interpretation of *opp* in (32) is arguably more directional than in (31).

- (32) a. Det bles [_{DynP} opp [_{SC} lauv på taket]].
 it blew up leaves on the roof
 'There blew leaves up on the roof'
- b. Det bles [_{DynP} opp [_{SC} lauv opp på taket]].
 it blew up leaves up on the roof
 'There blew leaves up on the roof'

The fact that there can be two different *opp* 'up' items in the structure is another argument that the upper *opp* has not moved from below.¹¹⁹

¹¹⁹ *///? *Det bles lauv opp opp på taket* 'there blew leaves up up on the roof' is impossible, I think, unless *opp* på *taket* is a kind of specification of the former *opp*, and hence an appositive.

Another example that indicates no movement from below is the following message found on a traffic sign in Trondheim:

- (33) Se opp for syklistar
 look up for bicyclists
 ‘Be aware of bicyclists’

This intransitive variant has no resultative/directional counterpart, and of course it is not an appeal for the pedestrian to look into the sky for flying bicyclists. Thus, it is reasonable to assume *opp* ‘up’ to be directly inserted into Dyn. In section 4.3.6, I will return to the possibility that all metaphorical/idiomatic particles might be directly inserted in Dyn.

Direct insertion of a particle into a functional domain is also possible in Ramchand’s (2008) model. Ramchand (2008: 135) gives the following example in which the particle is directly inserted in *res* and followed by a prepositional SC:

- (34) a. Mary danced in out of the rain.
 b. [InitP Mary dance [ProcP <Mary> <dance> [resP Mary in [pp Mary out of the rain]]]]

Ramchand assumes particles to have a resultative feature specified in the lexicon, so that an element that qualifies as a particle can move to or be inserted in *res* to check the feature there.

Why is it reasonable to assume that DynP is not present in RPrt constructions? The intuitive answer is that it is not needed there because the interpretation is not dynamic. Similarly, NegP is not generated and therefore non-existent in non-negated sentences. NegP is usually only assumed to be present when the sentence contains overt negation, not otherwise, so the negation/non-negation alternation is explained by assuming different underlying representations.

There are also other domains in which close alternations are analysed using different underlying representations. Consider double object constructions. In some accounts, (35a, b) are assumed to be derived from a common underlying structure (Larson 1988), but in others they are derived from different basic structures (Oehrle 1976, cf. also Tungseth 2008: 71ff). (36) could give us an indication that the latter solution is the better one (if it is not a different and lexicalised meaning of ‘give’).

- (35) a. Johan gav Margit blomar.
 ‘John gave Mary flowers’
 b. Johan gav blomar til Margit.
 ‘John gave flowers to Mary’
- (36) a. Johan gav Margit hovudpine.
 John gave Mary headache
 ‘John gave Mary an headache’
 b. *Johan gav hovudpine til Margit.
 John gave headache to Mary
 ‘John gave an headache to Mary’

I will not provide explicit analyses of these examples, but merely comment on them briefly. I assume that the a-versions can be represented with a double VP structure (or a PrP+VP structure), with the IO in the spec and the DO in the complement position of the lower VP. In the b-versions, I assume that the verb takes a SC complement: [_{SU} blomar [_{PRED} til Margit]]. The fact that the SC variant does not converge in (36b) supports an approach in which the a- and b- versions are analysed as having different structures. That is also the most economical analysis. The operations are few and simple, and the structures represent two productive frames that must be independently assumed for other reasons (in Norwegian) (cf. Åfarli 2007). In section 4.3.2, we discussed briefly how Bruening (2010) accounts for idiom formation through a selection of a lexical element, which in turn is interpreted idiomatically. In the case of (35)–(36), *hovudpine* ‘headache’, but not *blomar* ‘flowers’ will be selected by the verb. However, he notes explicitly on his p. 537 that *give NP a headache* is not really idiomatic, since both *give* and *headache* have their usual meanings, and *headache* can combine with a lot of verbs. But importantly, they cannot combine in (36b), which is an argument for treating *give NP a headache* as an idiomatic expression after all. Note that if we adopt an idiom formation analysis, that is not necessarily an argument against a derivational account. But a non-idiomatic analysis of (36) could suggest that the a- and b-versions in (35)–(36) are separate structures.

The frames assumed in (28) can be compared to Åfarli’s (2007) *frames* and Borer’s (2005) *templates*. My earlier claim that the structure is the primary carrier of meaning, cf. (23i), means that structures have a semantic value. More precisely, I assume that structures carry a *G(rammar)-semantic* value as defined in Bouchard (1995: 17). G-semantic values are

related in a homomorphic fashion to the syntactic structure. In section 4.3.4, I will discuss Bouchard’s categories of G- and S(ituational) semantics more thoroughly in light of prepositions. At this stage, I will just assume without further discussion that (28a) is a resultative frame, and (28b) is a dynamic frame. In other words, the G-semantics corresponding to (28a) is resultativeness, and the G-semantics corresponding to (28b) is dynamicity.

Åfarli (2007) develops a syntactic frame model for Norwegian, and his work is a variant of a more general exoskeletal approach exemplified by Borer (2005). The idea of syntax being “exoskeletal” simply suggests that the structure exists independently of and prior to lexical insertion:

[T]he syntactic structure gives rise to a template [= a frame], or a series of templates, which in turn determine the interpretation. For such an approach a listeme does not determine structure, but rather, functions as a modifier of structure. (Borer 2005: 14).

This point is essential. Following this idea, both examples in (37) below contain structures that are dynamic, but the inserted directional items, and the two verbs, modify the structure. Hence, the construction in (37a), with the lexical insertion of *lese* ‘read’, clearly has a perfective aspectual interpretation, while (37b), with the insertion of *kaste* ‘throw,’ is also clearly interpreted in a very “physical” directional sense. We will discuss the lexical modification of the structure more elaborately in section 4.3.4; the important notion at this stage is that the semantic values of the two underlying representations are identical.¹²⁰

- (37) a. lese [_{DynP} ut [_{DP} boka]]
 read out the book
 ‘finish the book’
 b. kaste [_{DynP} ut [_{DP} hunden]].
 ‘throw out the dog’

Note also that the exoskeletal tradition is mainly generative;¹²¹ in Construction Grammar (e.g., Golberg 1995), there is no generative engine generating the structures, and the structures

¹²⁰ However, as mentioned a couple of times already, I will suggest in section 4.3.6 that (37a, b) can also be structurally different, which would be compatible with Aarts’ (1989) approach.

¹²¹ Works by Lohndal (2012, 2014), Åfarli (2012), Nygård (2013), and Grimstad, Lohndal & Åfarli (2014) represent some of the more recent exoskeletal approaches applied to Norwegian and other languages.

are instead considered language-specific, which is not compatible with Borer's model. In Borer (2005), the structure is considered semantically valued and universal:

[T]he constructions (...) are in essence fragments of syntactico-semantic structures made available by UG, and (...) the inventory of grammatical configurations in any given language is constructed from these fragments (Borer 2005: 14).

Concerning the assumption that the same P can be inserted in the two frames in (28) (the RPrT frame and the LPrT frame), this is parallel to the assumption that the same verb can be inserted in different verbal frames in Áfarli (2007). For instance, the two most basic frames assumed by Áfarli (2007) are the intransitive and the transitive frames, cf. (38):¹²²

(38) a. Intransitive frame

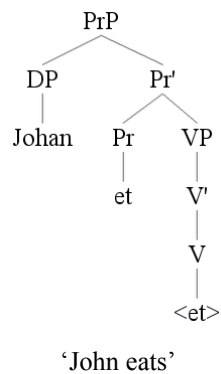

b. Transitive frame

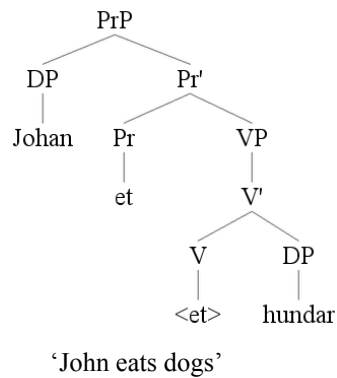

¹²² Áfarli adopts Borer's *predication operator* (Pr) and base generates all subjects in Spec, PrP. Note, as we saw further above, that the verb moves to identify Pr here.

The analysis suggests that *ete* ‘eat’ is not specified with a certain argument structure; rather, it can be inserted in an intransitive frame or a transitive one, which is the basic explanation of its grammatical flexibility (the lexical element is not specified with these features itself). This is similar to the assumption that a given P can be inserted in a RPr and a LPr frame. I encourage the reader to consult Borer (2005, 2013), Åfarli (2007), and Lohndal (2012, 2014) for further arguments in favour of an exoskeletal view.

4.3.4 *The Basic Semantics of Prepositions and the Lexical Modification of the Structure*

I claimed in section 4.3.1 that the full interpretation of a structure depends to a considerable degree on the fine-grained semantics of the lexical elements, cf. (23ii). I discussed the divergent structural semantics of RPr and LPr constructions above, cf. (23i), but we also saw in (37) how (23i) works in tandem with (23ii). In this section, I will continue investigating the lexical modification of the structure. I will not go very much into detail on verbal semantics, but at least I will distinguish between verbs that are easily associated with directionality (e.g. *kaste* ‘throw’) and verbs that are not (e.g. *tenkje* ‘think’). But first I want to discuss the semantics of the elements that lexicalise Dyn in most instances, namely prepositions.

The prepositions *opp* ‘up’, *ned* ‘down’, *inn* ‘in’, and *ut* ‘out’ can all be said to have a basic meaning expressing a direction (cf., e.g., Anderson 2010: 31ff).¹²³ However, they can also be used in a wide range of more abstract or metaphorical constructions, which in many cases cannot very easily be recognised as resultatives. The *interpretation* of the prepositional particle depends on its distribution (in a resultative or dynamic frame), and on which lexical elements combine with it (i.e., the verb and the DP). Shortly I will investigate the particle use of *opp* ‘up’ more closely, but in order to separate what is expressed by the preposition itself from what is expressed by its “surroundings,” I will first introduce the theory of (prepositional) semantics as discussed by Bouchard (1995).

In dictionaries, we find several lexical meanings listed under each prepositional lemma; the listed meanings are implied to be meanings of the preposition. The problem is that we usually do not get a clear idea of what counts as the semantics expressed by the preposition itself, and what is the interpretation of its context (cf. Aa 2013). In Bouchard’s (1995) terms, this amounts to mixing the linguistically relevant aspects of semantics, which

¹²³ As noted in section 2.1.2.2, these prepositions cannot be adnominal in Swedish. Lundquist (2012) suggests that they are not proper prepositions in Norwegian either, but that they select null prepositions in the apparent adnominal cases, as in *Dei gjekk opp Ø trappa* ‘they went up Ø the stairs’.

he calls the *Grammar (G-)semantics*, with the *Situational (S-)semantics*.¹²⁴ The former stands in a one-to-one relationship with the syntactic structure, so that every G-semantic representation has a syntactic correspondent; on the other hand, the S-semantic deals with pragmatics and world knowledge, and has no effect on syntax. A general problem when one mixes up these two levels is that there is no clear criterion for separating polysemy from homonymy (Bouchard 1995: 11, Aa in press), so it is difficult to tell whether all tokens of a preposition like *opp* ‘up’ are actually of the same lemma (other than typographically). This is a rather typical – and paradoxical – problem for dictionaries (Aa 2013).

Bouchard (1995: 13) illustrates his basic ideas with the French preposition *dans* ‘in’ in the following three examples (the translations are Bouchard’s):

- (39) les bijoux sont dans la boîte
‘The jewels are in the box’
- (40) la vache est dans la prairie
‘The cow is in the prairie’
- (41) le curé est dans la file
‘The priest is in the line’

In a global approach, three different representations of *dans* would be outlined, grounded on the fact that the complement looks different with respect to size, dimension etc. (three-dimensional objects usually being the most satisfactory for *dans*). But what is linguistically relevant in (39)–(41) is that *dans* in all three examples expresses a certain relationship between a container (Ground) and a containee (Figure) – and this is what Bouchard holds as essential for the abstract representation of the preposition. At least in spatial contexts, the container–containee relationship implies that “[t]he container controls the position of the containee and not vice versa”, and that “[t]he containee is included, at least partially, in the container” (p. 14). If we try to extend the generalisations to cover non-spatial contexts, this naturally implies a very broad understanding of the term “container”, in the sense that it sometimes must be construed temporally (*in December*) and as state of affairs, state of mind

¹²⁴ Bouchard also operates with a third, intermediate level, the *L(inguistic)-Grammar*, which deals with linguistically relevant meaning that does not affect the syntax. The important distinction for my purposes is whether syntax is affected or not, so the difference between S- and L-semantic will not be that relevant. I will refer to these two levels collectively as S-semantic.

etc. (*in duty, in anger*). Sometimes, e.g. in VPrt constructions, we must also account for the container to be apparently covert (as in *ta i* take in ‘use power’, ‘work hard’).¹²⁵ In this perspective, it is not the meaning of the preposition that changes (which is what the dictionary typically leads us to believe), but it is the meaning of the complement that decides whether the PP is construed as “locative”, “temporal” or something else.

A similar idea is also illustrated by Anderson (2010: 30ff). She proposes that all spatial prepositions have a basic semantics that is locative (which must be generally ‘localising’ rather than bound to a physical place), and the Norwegian *i* ‘in’ has a representation similar to *dans* as described by Bouchard. In the following examples (from Anderson’s p. 30), there is thus no grammatical difference between the representations of *i*; in all the examples, the Figure (the containee) is found somewhere (or somehow) within the Ground (the container).

- (42) a. Dei går i gatene.
 they walk in the streets
 ‘They walk/march in the streets’
- b. Dei går i tog
 they walk in train
 ‘They walk in a parade’
- c. Dei går i egne tankar
 they walk in own thoughts
 ‘They go in their own thoughts’
- d. Dei går i grøfta
 they walk in(to) the ditch
 ‘They walk in(to) the ditch’, *or, e.g.*,
 ‘They fail’

¹²⁵ Bouchard (1995: 94ff) suggests that in cases like this, more semantic nodes can be *chunked* into one syntactic node. It is not possible to account for an isomorphic mapping between semantic and syntactic nodes in all cases: “Suppose we propose the simplest linking rule possible, isomorphic mapping, where all elements of semantic representations map directly into SS in a one-to-one fashion. Under this assumption, it would seem that the hypothesis that semantic and syntactic representations are alike cannot be correct, since it would mean that there is no semantic decomposition of words, and there are numerous arguments in favor of decomposition of lexical items” (pp. 94f).

- e. Dei går i desember
 they walk in December
 ‘They go hiking in December’, *or*
 ‘They quit (their jobs) in December’

All these sentences are the same except for the semantics of the container: for example, it is locative in (42a) but has a temporal specification in (42e). But in all cases, whether the complement is concrete or more abstract, the basic meaning of the preposition does not really change. If *i* ‘in’ combines with an abstract DP *eigne tankar* ‘own thoughts’, the PP gets an abstract reading, crucially because of the meaning of the DP, not because P in this case is a variant with an abstract meaning. The P *i* just places a containee in this abstract container.

As indicated by the translation, (42d) is ambiguous between a locative and a directional interpretation if no further context is provided. Despite this fact, we do not have to postulate two representations of *i*, even though the directional variant has another English counterpart (*into*). Instead, we can postulate a resultative frame for the directional reading, so that *i* itself does not express direction or movement, but selects a resultative Ground. The different interpretations are thus based on the container being resultative or not.

Note also that I claimed the sentences “look” similar with the exception of the Ground element. The ambiguity of some of the sentences does not only imply different readings of the complement, but also different interpretations of the verb. In (42e), *gå* can refer to a hiking activity or someone planning to quit his/her job. But whether this ambiguity is based on our knowledge about the particular situation, according to which we will assign the appropriate interpretation of *gå*, or whether the ‘quit one’s job’ meaning is the result of idiom formation (as for Bruening 2010), it will not affect the G-semantics of *i*, which is constant. The interpretation of the verb is highly relevant for the interpretation (but not the meaning) of the particle, as we will see further below.

Finally, consider the following pair of sentences, which may be wrongly claimed to have similar meanings:

- (43) a. Johan er i bussen.
 ‘John is in the bus’
 b. Johan er på bussen.
 ‘John is on the bus’

Only the *i* ‘in’-construction is G-semantically a true locative, while *på* ‘on’ expresses that John is in contact with or involved in the activity of a bus journey. If the bus takes a break and John steps outside, he is still on the bus, but not *in* it. Most likely, John is in the bus in (43b) too, but that is an S-semantic conclusion based on our world knowledge. G-semantically, we do not get information regarding John’s position in (43b), only his activity.¹²⁶

Bouchard’s theory shows that the semantics of the preposition itself is *one* factor that contributes to the final interpretation of the PP. We will now see that the LPrt distribution triggers a particle interpretation of the preposition, which is different from the interpretation triggered by the RPrt distribution. Consider the following examples. (44a) is taken from Sandøy (1976) (thus, the judgement is from Romsdal Norwegian), and (44b) is my own example. (44a) has an aspectual reading; in Verkuyl’s (1989) terms it creates an accomplishment out of an activity (cf. also (45)–(48) below).

- (44) a. lese {ut} bokja {*ut}
 read {out} the book {out}
 ‘finish the book’
 b lese {*/??ut} hunden {?ut}
 read {out} the dog {out}
 ‘read (so much that) the dog (goes) out’

The only lexical difference between these examples is the DP, which denotes something inanimate in (44a) and something animate in (44b). From what I have said above, (44a) works well in the LPrt frame, but not in the RPrt frame. However, (44b) works slightly better in the RPrt frame, but not at all in the LPrt frame (unless *hunden* ‘the dog’ is the title of a book, and the example is of the (44a) type). The most natural interpretation will perhaps be that the dog gets so tired or “offended” by his owner’s reading that he walks out by himself. Structural-semantically, the converging variant in (44a) is provided with a dynamic reading, and the (near) converging variant in (44b) is provided with a resultative reading. This is the first step of interpreting only the latter as directional.¹²⁷

¹²⁶ See Aa (2013: 153ff) for further discussion.

¹²⁷ Given an appropriate context, Swedish *läsa* ‘read’ can be used in a directional setting. Mikael Vinka provided me with the following example:

- (i) Prästen läste ut den onda anden.
 the priest read out the evil spirit

Note that the preposition gets an unequivocal directional reading in the right-hand position only. The following particles all have a basic *directional* reading: *ut* ‘out’, *inn* ‘in’, *opp* ‘up’, *ned* ‘down’, *heim* ‘home’, *frå* ‘from’, *til* ‘to’, and *mot* ‘towards.’¹²⁸ This means that the basic reading of a directional preposition is in harmony with the RPrT frame. In (44), the verb does not contribute to a directional reading in either of the examples; the directionality is read off from the RPrT frame and also from the semantics of *ut* ‘out’. In fact, (44b) gets a directional reading despite the verbal semantics. Concerning S-semantic factors, we know that dogs have legs and are able to move (even without the assistance of a directional verb like *kaste* ‘throw’). Therefore, *hunden* ‘the dog’ fits well in a resultative and directional concept, S-semantically speaking. In (44a), the friction¹²⁹ between the structure (23i) on the one hand and the lexical elements (23ii) and world knowledge (23iii) on the other seems to be too salient, so the RPrT alternative crashes. At least in the Romsdal dialect, only the LPrT frame is possible, i.e., a structural-semantically dynamic concept. Of the three lexical elements, only *ut* ‘out’ is compatible with the RPrT frame. *Lese* ‘read’ is not a directional activity *per se*, and books do not have legs.¹³⁰ If we switched *lese* with *kaste*, we would have lexical elements

‘The priest exorcised the evil spirit’

However, I do not think that this use of ‘read’ works this smoothly in Norwegian. I guess *drive* ‘drive, exorcise’ would be the default verb, and it combines well with *ut* ‘out’ (*mane* ‘conjure’ can also marginally combine with *ut*, at least it is attested in *Norsk Ordbok*):

- (ii) Presten dreiv ut den onde anden.
 the priest drove out the evil spirit
 ‘The priest exorcised the evil spirit’

But note that light verbs work well to get a directional reading of the LPrT alternative in (44b):

- (iii) ha ut hunden
 have out the dog
 ‘get the dog out’

In (44a), it is slightly worse:

- (iv) ?ha ut boka
 have out the book
 ‘get out the book’

¹²⁸ *Mot* will also have the English translation ‘against’ in many cases, but that does not change the semantics of the Norwegian preposition. *Mot* is derived from the noun *mot* (= *møte* ‘meet(ing)’), so it basically means ‘in meeting with.’ Thus, whether the appropriate English counterpart is ‘towards’ or ‘against’ depends on other factors, such as the Ground, (connection to the) verb, context, interpretation, etc. Consider (i):

- (i) Johan gjekk mot hotellet
 John went/walked against/towards the hotel
 ‘John walked towards the hotel’, or ‘John went against (e.g., the opinion of) the hotel’

(i) is in its written form ambiguous as to whether John walked in the direction of the hotel or was against (e.g.) the building or opinion of the hotel. Only the latter interpretation is of a VPrT construction, and in this case we have a metaphorical reading of the verb too. *Hotellet* ‘the hotel’ does not mean the concrete building in the VPrT construction, but some kind of process (e.g., building or debate) involving the hotel. The S-semantics is in other words completely different in the different scenarios, but the G-semantics of *mot* remains identical. Similar examples will be discussed when we look at unaccusatives in chapter 5 (section 5.2).

¹²⁹ Cf. the discussion on the terms *friction* and *mismatch* on the one side, and *harmony* on the other, in sections 1.2.2 and 4.3.2.

¹³⁰ In a fantasy world, we could of course imagine that the book is magically compelled by the reading to move outside. But in a normal world, direction is less likely to associate with (44b) than (44a).

that were satisfactorily directional to be inserted in the RPrt frame (*kaste boka ut* is fine and has a directional meaning only). However, the elements *lese + ut + boka* are forced into the LPrt frame, and then the directional interpretation of *ut* is also lost.

There are several combinations that are strongly preferred in the dynamic LPrt frame, despite the fact that the combination contains a preposition with basic directional semantics and sometimes also a directional verb. When such combinations are inserted in the dynamic frame, the general directional interpretation is unavailable. Below, I summarise quite a few examples from the dictionary article on *opp* ‘up’ (Aa 2009a) in *Norsk Ordbok VIII*,¹³¹ categorised into four S-semantic (general-conceptual) groups. That is, I have reproduced the productive V + Prt pair and added a conventional DP (from my own world knowledge, so to speak) when one is not given in the dictionary. Concerning the translations, English would probably omit the particle in many of the examples; some readers might thus claim that they are lexical V + Prt pairs in Norwegian. However, I will again support a structural-semantic analysis, in which the structure is further modified by the lexical insertion and the S-semantic interpretations. The interesting observation concerning these examples is that they are all preferred (or obligatory) in the LPrt frame, and they all get some kind of a metaphorical (non-directional) reading.

(45) **Something starts or is activated**

- a. starte {opp} motoren {??opp}
start {up} the engine {up}
‘start the engine’
- b. kveikje {opp} lyset {opp}
light {up} the candle {up}
‘light the candle’
- c. gjere {opp} eld, varme {*opp}
make {up} fire, heat {up}
‘light the fire’

¹³¹ The information is also available here: < <http://no2014.uio.no/>> (accessed January 2014).

(46) **Something increases or improves in quantity or quality**

- a. hausse {opp} saka {??opp}
increase {up} the case {up}
'make the case more important'
- b. varme {opp} maten {*opp}
heat {up} the food {up}
'heat the food'
- c. skru {opp} lyden {?opp}
turn {up} the volume {up}
'turn the volume up'
- d. skru {opp} dampen {?opp}¹³²
turn {up} the speed {up}
'go faster'
- e. pusse {opp} stova {*opp}
brush {up} the living room {up}
'redecorate the living room'

(47) **Something is opened, divided or made clear**

- a. få {opp} ein knute {?opp}
get {up} a knot {up}
'open a knot'
- b. slå {opp} eit prektig gapplis {*opp}
open {up} a splendid yawnsmile {up}
'open up a splendid yawning smile'
- c. ta {opp} glaset, døra {?opp}
take {up} the window, the door {up}
'open the window, the door'

¹³² RPrt-constructions like the following are found in the Norwegian literature (and taken from *Norsk Ordbok*):

- (i) Ingri skrudde dampen opp.
'Ingri turned the speed up'
- (ii) Alfemann skrudde lyden opp.
'Alfemann turned the volume up'

These examples show an *increase* of speed and volume, respectively, and the new states of higher speed (i) and louder volume (ii) are identified as results in the RPrt frame. Note that the basic meaning of *opp* 'up' is also more "available" in these examples. They get some kind of an "up on a scale reading" (from a low to a higher level). Since the two examples are from written *Nynorsk*, we can also alternatively ascribe the use of the RPrt frame to the Danish influence on the *Nynorsk* standard (cf. Aasen 1864: § 334, and also sections 2.1.1 and 4.6 here).

- d. lukke {opp} glaset, døra {?opp}
close {up} the window, door {up}
'open the window, the door'
- e. dele {opp} kaka {?opp}
divide {up} the cake {up}
'slice the cake'
- f. rive {opp} isen {?opp}
tear {up} the ice {up}
'tear up the ice'
- g. splitte {opp} saumen {*opp}
split {up} the seam {up}
'split the seam'

(48) **Something or someone is finished, ended**

- a. ete {opp} maten {?opp}
eat {up} the food {up}
'eat all of the food'
- b. bruke {opp} pengane {?opp}
use {up} the money {up}
'spend all of the money'
- c. drikke {opp} ølen {?opp}
drink {up} the beer {up}
'drink all of the beer'
- d. seie {opp} åtte tilsette {??opp}
say {up} eight employees {up}
'fire eight employees'
- e. jule {opp} naboen {??opp}
beat {up} the neighbour {up}
'beat up the neighbour'

Again, the particle creates an accomplishment (of an activity) in each of the examples (cf. Verkuyl 1989). But in these four major conceptions, the verb and the DP are in many cases “responsible” for the specific S-semantic categorisation. For example, *starte* ‘start’ and *kveikje* ‘light’ are obviously perfect for the category in (45), where something starts or is

activated. But note that we might also end up with a similar interpretation with a less specific verb like *gjere* ‘make, do’, as in (45c). The fact that all of the examples in (45)–(48) converge smoothly given the LPrt frame, and that the direction is not traceable in (almost) any of them, suggests that the frame is primary. I claimed based on Bouchard (1995) that each preposition has a basic G-semantic meaning; *opp* ‘up’ probably means something like ‘in an upward direction.’ The fact that *opp* can be used so frequently in the LPrt frame and in so many combinations where its G-semantics is blurred strongly suggests that the theory of a constant G-semantic value associated with each lexical item presupposes a sentential frame that is capable of overriding it, cf. the model in (23) above.

It is also important to notice that not all of the examples crash in the RPrt frame either, cf. (46c, d), and that the judgement can vary between Norwegian dialect speakers. In general, however, it seems that the examples in (45)–(48) are somewhat awkward in the RPrt frame. I think this is an indication that there is more friction between this frame and the given lexical elements (despite the fact that *opp* is directional). If a verb and a DP that are generally hard to fit into a directional concept (cf. *dele* ‘slice’, *kaka* ‘the cake’) are inserted into the RPrt frame by a speaker, it sounds strange. Nevertheless, the hearer will still be able to interpret it correctly, due to his knowledge of the lexical elements – and probably also because of the conventions of the language. By the latter I mean that he will hear the combinations in the LPrt frame in most cases, and this develops into a convention that helps him in cases where there is friction.¹³³ I think it is appropriate to keep using the term *(dis)preference* (and also to refer to different preferences among speakers), since there are in many cases no absolute boundaries between what counts as acceptable and unacceptable. Therefore, different degrees of friction between the structure and the lexical elements, and between general G- and S-semantics, are suitable criteria to use.

4.3.5 World Knowledge: S-semantic Modification of Structural Semantics

As discussed above, I will move forward on the assumption that grammar operates with two semantically distinct VPrt structures, which in turn will have their respective semantics confirmed or contradicted by the lexical elements. In addition, the structure will be modified

¹³³ Whether frequency can explain syntactic structure (Newmeyer 1998: 134ff is very sceptical) and whether the more frequent structure is also automatically the default structure (cf. Dryer 1989, 1995) are questions that go beyond the scope of our study. I assume that frequency plays a significant role in interpretation, and in performance factors such as acquiring the conventions of a language.

by contextual information and e.g. world knowledge, so that the final interpretation depends on several factors.

Now, to take the discussion a step further, in this sub-section I will discuss some examples that clearly illustrate the importance of world knowledge when it comes to the final interpretation of a VPrt construction. Consider the following pair.¹³⁴

(49) a. **RPrt:** *køyre bilen inn*
drive the car in
'drive the car inside (e.g., into the garage)'

b. **LPrt:** *køyre inn bilen*
drive in the car
'drive the car inside', *or*
'break in the car'

(50) a. **RPrt:** *-gå skoa inn*
walk the shoes in
'walk the shoes inside'

b. **LPrt:** *+gå inn skoa*
walk in the shoes
'break in the shoes'

The lexical elements in (49) converge both in the RPrt and LPrt frames, but there is a clear difference between the two. In the RPrt frame, the sentence unambiguously expresses a directional concept, i.e., to drive the car from outside to inside (e.g., a garage). In the LPrt frame, this reading is also possible, but here *køyre inn* can also be construed as 'break in.' In the RPrt case, the resultative frame is confirmed by the lexical elements, so to speak. There is harmony between *inn*'s base position and its G-semantic content. There is also another important detail: To park a car in a garage is a general concept with which most speakers are very familiar, so driving a car inside is easily associated with such an action. Even when the

¹³⁴ As mentioned in section 1.1.2, I follow Sandøy (1976) and use a plus sign (+) to mark the preferred alternative and a minus sign (-) to mark the dispreferred alternative. Unlike examples with a question mark, the examples with a minus sign are grammatically fully acceptable, but just sound more awkward.

same lexical elements are inserted in the LPrt frame in (49b), the directional interpretation is possible – partly because of the conventionalised concept of parking a car inside some building. In (49b), the dynamised structure is generated, and thus the alternative, metaphorical reading of *køyre inn* ‘break in’ is favoured. This is exactly where the relevance of world knowledge is important. Our knowledge of the situation type or the particular situation contributes to the final interpretation. If we know that John bought a new car, the metaphorical reading can be triggered. If we are waiting for John to come home and we finally hear the car outside the house, then the directional reading is also appropriate when the LPrt frame is generated in the first place.¹³⁵

What about (50)? The lexical elements employed here are not too different from those employed in (49). The particle is identical and the two verbs are both clearly associated with direction. Furthermore, shoes are an instrument for walking, just as a car is an instrument for driving. Let us begin with the LPrt structure in (50b). When the LPrt frame is generated, the metaphorical reading of *gå inn* ‘break in’ is available here, too. But a directional interpretation is less accessible. If the RPrt frame is generated, this particular example is much less likely to converge. –*Gå skoa inn* sounds strange despite the fact that all of the three lexical elements in isolation are easily associated with directionality.

What is the problem here? Again, I think the solution has to do with world knowledge. In contrast to driving the car inside (to park it), we have no established everyday concept of walking shoes inside (something), e.g., to leave them there and continue without them. That is, people usually take their shoes off in the hall, but ‘in order to take one’s shoes off’ is not the reason for walking inside. The concept of walking the shoes from outside to inside is non-existent. The concept is only marginally accessible, say, on a warm summer day, where it might be desirable take one’s shoes inside to prevent the feet from getting warmer. However, *ta* ‘take’ would be a more conventional verb to use in that context. Clearly, non-linguistic factors demonstrate their explanatory relevance in (49) and (50). There are apparently no linguistic reasons why the RPrt construction in (50a) should be any worse than (49a), or why the LPrt construction in (49b) is ambiguous while (50b) is not.¹³⁶

A similar example to (49) is found in (51):

¹³⁵ In section 4.3.6, I will suggest that the metaphorical and directional readings of this LPrt construction may also be structurally founded.

¹³⁶ There is an alternative linguistic explanation: one could argue that *køyre* ‘drive’ has a transitive variant that assigns Case in (49a), while *gå* ‘walk’ does not, and therefore (50a) fails. The respective b-versions with the ‘break in’ readings will be subject to idiom formation (cf. Bruening 2010).

- (51) a. *køyre posten ut.*
drive the mail out
‘drive the mail out (with a car)’
- b. *køyre ut posten*
drive out the mail
‘drive out the mail (with a car),’ *or*
‘distribute the mail (idiomatic reading of *køyre*)’

(51a) has the unambiguous directional reading of bringing the mail out to the customer by using a car. The ambiguity in (51b) is exactly the same as in (49b). Despite the primary LPrt frame, the directional interpretation is possible here. (I assume the processes of lexical insertion and adding S-semantic information to be parallel to the process discussed above.) However, the combination *køyre ut* ‘drive out’ can also have the general reading ‘distribute’, whether it combines with a concrete DP like *posten* ‘the mail’ or a more abstract one like *informasjonen* ‘the information.’ The latter example clearly demonstrates that a vehicle need not be included in this interpretation. *Køyre ut informasjonen* ‘distribute the information’ can be accomplished by using e-mail. In sum, here again we have a LPrt construction which is ambiguous apparently due to different S-semantic factors.

4.3.6 Two Types of LPrt Constructions: Predicational and Non-Predicational

I suggested in section 4.3.3 that the LPrt frame is non-predicational, with direct insertion of the particle in Dyn. This is more economical than the predicational alternative, which would suggest that DynP takes a SC complement and that the particle moves from the SC head position to Dyn. The two alternatives are repeated here, using (51b) as an example:

- (52) a. **Assumed LPrt frame**

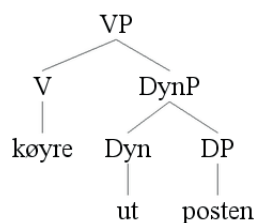

b. Alternative LPrt frame

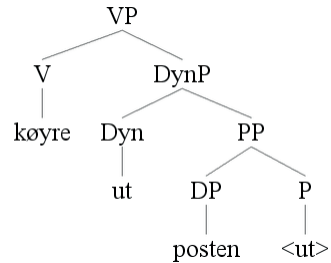

Now, is there a possibility that the two different interpretations of (51b) that we discussed above are actually structurally based, as suggested in (52)? If that were the case, we could assume that only the metaphorical reading has a non-predicational structure with the particle directly inserted in Dyn, while the directional LPrt variant is the result of particle movement as in (52b). Aarts (1989: 283) similarly suggests a predicative account for the directional constructions and a non-predicative VP-internal particle in the metaphorical/idiomatic constructions. Although a VP-internal particle is problematic (because an adverbial will split up the V and Prt in V2 contexts), a structural difference between directional and metaphorical constructions is compatible with Aarts' approach.

This would in turn explain why the metaphorical constructions for many speakers do not have a RPrt counterpart, cf. Sandøy's (1976: 107f) examples mentioned in section 4.2.1. I repeat the examples here:

- (53)
- a. å måle {opp} gard'n {*opp}
to measure {up} the farm {up}
'to measure the size of the farm'

 - b. Han ha plikt te å låne {ut} varå {*ut}
he has duty to to lend {out} goods {out}
'He is obliged to lend the goods'

 - c. Han he rekna {ut} prisan {*ut}
he has calculated {out} the prices {out}
'He has calculated the prices'

- d. ... korleis me laga {te} mat {*te}
 ... how we made {to} food {to}
 '... how we prepared the food'
- e. Han las {opp} brevet {*opp}
 he read {up} the letter {up}
 'He read the letter loudly'

Notice that the V + Prt combinations here are considered 'idiomatic' by Sandøy; they are non-directional and usually cannot occur with other particles.¹³⁷ The tight V–Prt relationship can be explained if the particle is directly inserted in Dyn and has no predicational origin. That could be the definition of what is in many cases construed as a VPrt idiom: a particle that is directly inserted in Dyn is non-predicational and forms an idiom-like unit with the verb. In many cases, these 'idiomatic' combinations can be replaced by a transitive verb:¹³⁸ *køyre ut* 'drive out' = *distribuere* 'distribute', *legge ned (på boks)* 'lay down (on can)' (Sandøy 1976) = *konservere* 'preserve', *lage til* 'make to' = *(føre)bu* 'prepare', etc. In the examples above, the omission of the particle is possible and has also less impact on the final interpretation of the structure than the omission of a directional and predicational particle. What are referred to as lexicalised V + Prt pairs in the literature are thus explained by a generation of and insertion into a frame of the type in (52a). Notice also that the examples in (53) cannot have their particles extracted, and if we extract the particle in (52), cf. (54a), the directional interpretation is unambiguously chosen:

- (54) a. Ut køyrdde han posten (unambiguously directional)
 out drove he the mail
 'He drove the mail out'

¹³⁷ The latter is not true for all these combinations. E.g., *lese* 'read' + *brevet* 'the letter' can certainly get an aspectual reading with a left-handed *ut* 'out' or *inn* 'in'. *Rekne ut* 'calculate out' can also have an aspectual reading with *opp* 'up', *med* 'with', and *inn* 'in':

- (i) rekne ut/opp/med/inn alle deltakarane
 calculate out/up/with/in all the participants
 'count (in) all the participants'

¹³⁸ Cf. also the discussion on I-selection and metaphorical constructions in 4.3.2.

- b. *Opp målte han gard'n.
 up measuerd he the farm
 'He measured the size of the farm'
- c. *Ut har han plikt til å låne varå.
 out has he duty to to lend goods
 'He is obliged to lend the goods'
- d. *Ut har han rekna prisan.
 out has he calculated the prices
 'He has calculated the prices'
- e. *Opp las han brevet.
 up read he the letter
 'He read the letter loudly'

(54) should be directly predicted from (52). In (52a), the particle is directly inserted in Dyn and cannot be topicalised, i.e., A'-moved, since it is a head. This must be the case with (54b–e). If we assume a bar level (or a maximal projection, in BPS) above P in (52b), (54a) is predicted to converge, cf. (55):

(55)

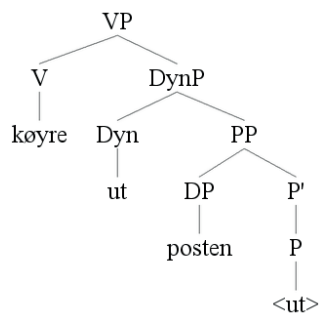

There are in other words good syntactic reasons to assume that LPrT constructions exist in two variants: one variant with direct lexicalisation of Dyn (the metaphorical construction), and one derived from the corresponding RPrT variant (the directional construction).

In RPrT constructions, a predication relation between the DP and P is established, and the directional frame in (52b) is derivationally related to the RPrT frame in that it has a predicational projection headed by the particle. However, the presence vs. absence of DynP separates directional LPrT constructions from RPrT; I assume that the presence of DynP triggers obligatory particle movement (conversely, DynP is absent from all RPrT constructions). I further assume that the consequence of particle movement is a weakened predication relation between the particle and the DP, and thus a devalued subject status of the DP. In section 3.1.2, I discussed Taraldsen's (1983) categorisation of RPrT constructions as predicational and LPrT constructions as non-predicational. One of the examples he gives is the following (the judgement is Taraldsen's):

- (56) Vi jaget {*ut} ulven {ut} for å PRO gjenfinne sin tapte frihet.
 we chased {out} the wolf {out} to again-find REFL lost freedom
 'We chased out the wolf so that it could get back to its lost freedom'

Taraldsen (1983) analyses RPrT constructions as the result of leftward DP movement to the SC subject position, as shown in (57).

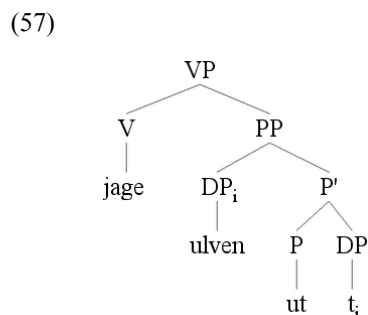

As discussed in section 3.1.2, PRO subjects in infinitives initiated by the purposive *for å* 'in order to' need to be controlled by a subject from the matrix clause. Since *ulven* 'the wolf' apparently functions as a subject only in the RPrT case, the LPrT ban and RPrT convergence in (56) should follow from that.¹³⁹ The singular form of the antecedent *sin* 'itself' suggests that the antecedent of the PRO subject is a singular noun. The RPrT construction thus converges

¹³⁹ The finite control example of (56) would be the following:
 (i) Vi jaget {ut} ulven {ut} for at den skulle gjenfinne sin tapte frihet.
 we chased {out} the wolf {out} for that it should again-find REFL lost freedom
 'We chased out the wolf so that it could get back to its lost freedom'

because PRO is controlled by *ulven*.SG, which matches the anaphor *sin*. The LPrt construction crashes because PRO is controlled by *vi*.PL ‘we’, which does not match the anaphor.¹⁴⁰

I argued in chapter 3 that Taraldsen’s judgement of (56) is too categorical or rigid. There is surely a difference between the two alternatives, but it is more nuanced than suggested by Taraldsen. None of the examples are perfect, probably because it is generally difficult not to relate the interpretation of a purposive infinitive to the matrix subject and verb. The mismatch between *vi* and *sin* therefore affects both of the alternatives. However, the RPrt alternative is slightly better, which can be explained if we assume the LPrt variant to be derived as in (52b). When the particle moves to identify Dyn, the predication relation between *ulven* ‘the wolf’ and *ut* ‘out’ is weakened, and subject status of *ulven* is devalued. The antecedent–anaphor mismatch is more intrusive in this case, but the difference is still not as clear as indicated by Taraldsen’s judgements in (56). This can be seen as an argument for maintaining a predicational structure even in the LPrt case, i.e., that directional LPrt constructions have the structure in (52b) rather than the one in (52a).

Drawing this conclusion also enables us to explain the creation of the “dynamic unit” in (52a) in terms of idiom formation. Bruening (2010: 532) assumes a principle of idiomatic interpretation formulated as follows: “X and Y may be interpreted idiomatically only if X selects Y.” A further restriction is that Y must be a lexical category, and that all of its selected arguments must be interpreted idiomatically, given that both X and Y have idiomatic interpretation. In our system, the hypothesis would be that when V selects DynP, and Dyn is lexicalised with P directly, then P will get an idiomatic/metaphorical reading. Note that in (53), only the particle has the idiomatic reading, not V or the DP. This holds also for all of the examples in (45)–(48) in section 4.3.4. As noted by Marantz (1984, 1997), den Dikken (1995: 92), Bruening (2010) and others, idioms are usually V–DO-oriented and hardly ever SU–V-oriented. In the case of VPrt constructions, they are usually Prt-oriented and sometimes also include V and the DP. We will see in chapter 5 (section 5.3) that all VPrt constructions are in some sense ambiguous. As a consequence, the verb in an example such as *kaste ut hunden* ‘throw out the dog’ is in most cases probably (though not necessarily) provided with a metaphorical reading.

The predictions that can be made on the basis of (52) are as follows: First, that all constructions resulting from insertion into the non-predicational frame (52a) will get a metaphorical/idiomatic reading, and second, that all LPrt constructions inserted into the

¹⁴⁰ See 3.1.2 for more problems with Taraldsen’s example.

alternative frame (52b) will get a resultative reading where that reading is devalued as an effect of the obligatory particle movement. The predicational devaluation does not result in a metaphorical interpretation, but resultativeness (directionality) is still traceable. Idiom formation in the particle context is thus the result of direct lexicalisation of Dyn.

Given this analysis, we could ask the following questions: Does the separate frame in (52a) make the semantic motivation for particle movement in (52b) less appropriate? Is there really a semantic difference between directional LPrt and RPrt constructions? Examples like (56) show that there is in fact such a difference. Also, recall the results discussed in section 2.1.2.3. I repeat the table that sums up the results for standard VPrt constructions (without a complement PP) in the Nordic Dialect Corpus here:

(58) **Directional and metaphorical VPrt constructions from the NDC**

| | Dir. LPrt | Metaph. LPrt | Dir. RPrt | Metaph. RPrt |
|--------------------|------------------|---------------------|------------------|---------------------|
| West Norw. | 30 | 47 | 4 | 3 |
| East Norw. | 53 | 59 | 8 | — |
| Trøndsk | 27 | 23 | — | — |
| North Norw. | 39 | 56 | 7 | — |
| South Norw. | 18 | 16 | 4 | — |

Considering just the directional results, 167 of 190 = 88 % are LPrt constructions. Clearly, there is not free alternation between directional LPrt and RPrt distribution. However, the massive LPrt dominance does not automatically imply a semantic difference; it could also indicate a prosodic preference, i.e., that the LPrt preference is due to the spell-out of V + LPrt as a prosodic unit. However, an explanation based on prosody would be weak since it is not only the dialects with this particular spell-out that prefer LPrt. We saw in section 2.2 that there are mainly the dialects in East Norway, Trøndelag, Nordmøre, Romsdal, and Inner Sogn which have V + LPrt standardly spelled out as a prosodic unit (Sandøy (1985: 71). But note that in South, West, and North Norwegian, where a prominent LPrt is the default in many of the local varieties,¹⁴¹ LPrt is still definitely preferred. The preferred order is therefore not due to striving for a certain pronunciation, but is more likely semantically based. In the two

¹⁴¹ However, we did see that the spell-out of V + LPrt as a prosodic unit is probably expanding; it is noted from the Sunnmøre dialect by Abrahamsen (2003) and from the Rana dialect by Skaalbones (2006).

following sub-sections, I will continue to argue for an analysis based on a semantic difference.

4.3.7 Verbs with Inherently Specified Direction

Some verbs seem to have a certain direction inherently specified in their semantics; four obvious examples are *klatre* ‘climb’, *flytte* ‘move’, *pakke* ‘pack’ and *lukke* ‘close’ (see Aa 2004: 90 for a discussion in Norwegian). *Klatre* is usually understood as an activity that involves going up a wall, a tree, or something similar. If one is climbing down a wall, it must be explicitly specified with the particle *ned* ‘down.’¹⁴² Likewise, *flytte* ‘move’ has an inherent specification corresponding to *ut* ‘out’, and not *inn* ‘in.’ *Eg skal flytte* ‘I’m going to move’ specifies only that I’m moving out of my current house, not into a new one. The latter reading must be explicitly specified with *inn* ‘in.’ Finally, *pakke* ‘pack’ and *lukke* ‘close’ are similar to one another. *Pakke* has meanings corresponding to *ned* ‘down’ (in a suitcase) or *inn* ‘in’ (when wrapping gifts) inherently specified (something is hidden from the surface).¹⁴³ If the antonym of *inn* ‘in’, i.e., *ut* ‘out’, is specified (*pakke ut* ‘pack out’), the result is equivalent to the negative verb in English: *unpack*. In that sense, one could say that the antonym of the inherently specified particle *negates* the basic meaning of the verb. Similarly, *lukke* is inherently understood with a meaning corresponding to *att* or *igjen* ‘back’, and can be negated by *opp* ‘up.’ *Lukke opp* ‘close up’ means to open; the particle is the negation. The last example is taken from a Norwegian hymn: *Å løft ham sakte ned* ‘Oh lift him slowly down’, where the lexical content of the verb is clearly opposite of that of the particle.

¹⁴² However, a locative adverbial can blur the direction, cf. the locative (i) vs. the directional (ii):

- (i) Han klatrar i treet
‘He climbs in the tree’
- (ii) Han klatrar opp i treet
‘He climbs up in the tree’

The default direction of climbing is still upwards, just as the default direction of walking is forwards. Climbing downwards is a backing movement (at least for humans), similar to walking backwards. If walking does not happen in a forward direction, it must similarly be specified with a particle, an adverbial or further context.

¹⁴³ Note that the transitive (i) is different from (ii):

- (i) pakke kofferten
‘pack (into) the suitcase’
- (ii) pakke øskja
‘pack the box.’

Kofferten ‘the suitcase’ has a Ground interpretation (something is packed into the suitcase), while *øskja* ‘the box’ does not (the box itself is packed flat). Since a suitcase and a box are similar in many respects (they can be filled with stuff), this difference must be conventionalised (S-semantic), and does not change the meaning of *pakke* ‘pack’.

In (59), the inherently specified direction of each of the four verbs is given in parentheses (indicated by a particle). I also show the antonym or negating particle.

- (59)
- | | |
|------------------------------|---------------------------|
| a. Klatre (<i>opp</i>) | Neg Prt: <i>ned</i> |
| 'climb (<i>up</i>)' | 'down' |
| b. Flytte (<i>ut</i>) | Neg Prt: <i>inn</i> |
| 'move (<i>out</i>)' | 'in' |
| c. Pakke (<i>inn, ned</i>) | Neg Prt's: <i>ut, opp</i> |
| 'pack (<i>in, down</i>)' | 'out, up' |
| d. Lukke (<i>att</i>) | Neg Prt: <i>opp</i> |
| 'close (<i>back</i>)' | 'up' |
| e. Løfte (<i>opp</i>) | Neg Prt: <i>ned</i> |
| 'lift (<i>up</i>)' | 'down' |

Is there a possibility that these verbs have an inherently specified particle in their phrase structure when used bare? That is to say, could it be that V selects DynP in the following apparently transitive example: *Johan lukka døra* 'John closed the door'?

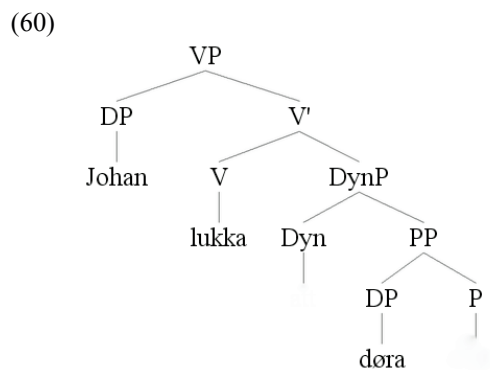

Intuitively, it seems stipulative to suggest that *døra* 'the door' is not the object of *lukka* 'closed', but rather the subject of a particle-headed causative SC. A consequence of such an analysis should be that the DP behaves like a subject when extracting a sub-part of it. Extracting a sub-part of a left-branched phrase (i.e., a subjects or an indirect object) is usually not feasible, cf. the *Left-Branch Subpart Condition* (Carrier & Randall 1992: 206). In (61a), a sub-part of the object is extracted, and in (61b) a sub-part of the subject is extracted. Clearly,

the former is better. In (62), taken from den Dikken (1995: 42), a part of an ordinary SC subject is extracted, and this construction also crashes. Such tests are traditionally used to motivate a predicational analysis of the structure.

- (61) a. Kva såg du at mannen i gul dress røykte slutten av ___?
 what saw you that the man in yellow suit smoked the end of ___
 ‘What did you see that the man in a yellow suit smoked the end of?’
- b. *Kva såg du at mannen i ___ røykte slutten av ein sigarett?
 what saw you that the man in ___ smoked the end of a cigarette
 ‘What did you see that the man in ___ smoked the end of a cigarette?’
- (62) *Who did they consider the brother of ___ a fool?

If an analysis along the lines suggested in (60) were correct, we would also expect an extraction of a sub-part of the claimed SC subject in (60) to fail as well, but interestingly it does not, as shown in (63a). Furthermore, an overt LPrt does not make the extraction impossible either, but an overt RPrt does, cf. (63b).

- (63) a. Kva såg du at han lukka den øvste delen av ___?
 what saw you that he closed the uppermost part of ___
 ‘What did you see that he closed the upper part of ___?’
- b. Kva såg du at han lukka {att} den øvste delen av ___ {*/??att}?
 what saw you that he closed {back} the uppermost part of ___ {back}?
 ‘What did you see that he closed {PRT} the upper part of {PRT}?’

Both Kayne (1985: 102f) and den Dikken (1995: 42f) use examples like the failed RPrt variant in (63b) to argue for an SC representation of VPrt constructions in general, while Dehé (2002: 18f) uses examples like the converging LPrt variant in (63b) in her extended argumentation against the SC analysis of VPrt constructions.¹⁴⁴

¹⁴⁴ As discussed in section 3.5.5, I consider Dehé’s use of paraphrases with *to be*, and also other constructions that demand a locative preposition, as inappropriate to decide whether a directional VPrt construction is

As I have argued, there are good reasons to analyse VPrT constructions in most cases as predicational (except for the metaphorical constructions, cf. section 4.3.6), both on general semantic grounds and also based on more specific evidence pertaining to binding properties, among others. For the purpose of this section, notice that since the variant with an overt LPrT in (63b) does converge, it is still theoretically possible to account for a covert particle and hence subject status for the DP in (63a). However, there is a difference in grammaticality in (63b) with respect to the particle distribution; the RPrT alternative is arguably worse. This could suggest that only the RPrT construction features extraction of the sub-part of a *real* subject. This alternative will be explored in the next sub-section. There is a possibility that the inherently understood particles in (59) are not structurally given, but included or interpreted on a general-conceptual level. In that case, the silent particle in (60) is not really part of the structure, but still its conceptual correlate could be S-semantically present somehow.

4.3.8 *The Weakening of the Predication in LPrT Constructions*

It is somewhat stipulative to try to account for a causative representation of *lukke* ‘lock’ with a covert particle in (63a), since extraction of a sub-part of the lower DP is felicitous. Although the verb implies directionality, I will assume that both the positive and the negative particle must be explicitly specified in order to get the resultative G-semantics.

To my mind, the most interesting point concerning the examples above is the difference between the LPrT and RPrT construction in (63b). In sections 3.1.2 and 4.3.6, we saw that Taraldsen (1983) treats RPrT constructions as SCs, while LPrT constructions in his analysis are not predicational. However, I concluded that the difference between these constructions should rather be interpreted as a difference in predicational tendencies than as an absolute dichotomy. Thus, we seem to be faced with a weakening of the predication in LPrT constructions. In (63b), there is a difference between the LPrT and RPrT distribution that supports this hypothesis; the LPrT variant converges more smoothly, because the DP is devalued as a subject. The RPrT variant fails because the DP functions as a proper subject in a

predicational or not. The verb used in the paraphrase decides which preposition to use: The SC in (i) can have both the paraphrases in (ii) and (iii):

- (i) Han kasta [_{SC} hunden ut]
‘He threw the dog out’
- (ii) ... slik at hunden **forsvann ut**
‘... so that the dog disappeared out_{DIR}’
- (iii) ... slik at hunden **hamna ute**
‘... so that the dog ended up out_{LOC}’

Both (ii) and (iii) are resultative, but only (ii) demands a directional preposition.

resultative SC. The dynamised (LPrt) structure thus somehow seems to have lost some of its clausal properties, resulting in the devaluation of the DP's subject status.

Note also that if the subject recognition test is reliable (which I think it is), and if we assume that only RPrt constructions have proper subjects, then nothing in principle excludes an account that assumes a silent LPrt in (60). Wh-extraction is felicitous in (60), just as it is in the LPrt variant in (63b). However, it is important to notice that this particular extraction test does not favour the analysis of (60) as an LPrt construction rather than a transitive construction. Wh-extraction of a direct object is possible. Therefore, we only know that there is at least not a silent RPrt in (60), since it would crash like the RPrt variant in (63b). In sum, I think it is more reasonable to construe the meaning corresponding to a putative covert particle in (60) as an effect of non-structural (S-semantic) properties.

4.4 Complex VPrt Constructions

4.4.1 Constructions with a Full Resultative PP

In section 2.3, it was shown that VPrt constructions followed by a full resultative PP (complex VPrt constructions) generally have a more right-bound particle than standard VPrt constructions. In conservative *Bokmål*, RPrt could even seem to be obligatory in such cases, cf. (64) from Hulthén (1948: 168). Sandøy (1976: 105f) claims RPrt to be preferred in directional complex constructions, cf. (65), and he claims alternation to be free in the complex metaphorical variants, cf. (66). All of the following examples are repeated from section 2.3.

- (64) Neste morgen satte Elisas hesten og vognen inn i en låve.
next morning put Elias the horse and the wagon into in a barn
'The next morning, Elias put the horse and the wagon into a barn'
- (65) a. Han bar {?ut} fangst'n sin {+ut} åt dei fattige.
he carried {out} the catch REFL {out} to the poor
'He carried out his catch to the poor'

- b. Dei løfta {(?)opp} kassa {+opp} i lastebilen.
 they lifted {up} the box {up} in the truck?
 ‘They carried the box up in the truck’
- (66) a. Han delte {ut} fangst’n sin {ut} åt dei fattige.
 he handed {out} the catch REFL {out} to the poor
 ‘He handed out his catch to the poor’
- b. Han tenkte å legge {ned} noko tå sild’n {ned} på boks.
 he thought to lay {down} some of the herring {down} on can
 ‘He intended to lay some of the herring down on can’

Let us compare these data with the standard constructions that I have already discussed. In the Romsdal dialect, the situation concerning directional and metaphorical standard and complex constructions is (somewhat idealised) as in (67) and (68). Standard metaphorical constructions are obligatorily used in the LPrt frame, cf. (68a), but are allowed in the RPrt frame when they are complex, cf. (66), corresponding to (68b). A directional complex construction is preferred in the RPrt frame, cf. (65), corresponding to (67b), while a directional standard construction is preferred in the LPrt frame, cf. (67a).

- (67) a. standard directional: {+LPrt} {RPrt}
 b. complex directional {?LPrt} {RPrt}
- (68) a. standard metaphorical: {LPrt} {*RPrt}
 b. complex metaphorical: {LPrt} {RPrt}

In the Nordic Dialect Corpus (NDC, Johannessen et al. 2009), there is a slight preference for RPrt distribution in complex constructions. Out of 36 complex constructions (= around 10 % of the number of standard constructions in the corpus), 20 were RPrt constructions. Most of the 16 complex LPrt constructions were metaphorical. The RPrt constructions had a significantly higher proportion of directional readings (see section 2.3 for the details).

I raised a question in section 2.3 about whether Sandøy’s examples *dele ut åt dei fattige* ‘hand out to the poor’ and *legge ned på boks* ‘lay down on can’ are really metaphorical; Sandøy argues that they are fixed expressions that have lost their basic

directional reading. Notice that these examples are quite comparable to *pakke ned* and *pakke opp* from the previous section. I construed *pakke ned* and *pakke opp* as directional; maybe Sandøy's examples are in the grey area. However, there is also an indication that his classification is correct: we can replace *legge ned* with *konservere* 'conserve', and *dele ut* with *distribuere* 'distribute.' Direct particle insertion in Dyn corresponds to the lexicalisation view in Sandøy's system. Another argument that Sandøy's classification is correct, is that the particle in (65a) is easier to extract than the one in (66a): *Ut bar han fangsten* vs. **Ut delte han fangsten*. This is compatible with the discussion in section 4.3.6, where it was shown that extraction of the particle in standard metaphorical constructions is impossible.

The reason why the resultative PP complement goes hand in hand with RPrt is quite simple: In the RPrt frame, the Ground is already established with the right-handed preposition, and when this preposition takes a complement, the result is a complex construction. This is the unmarked pattern and also the traditional prescriptive "norm" in the written standards.¹⁴⁵

However, LPrt constructions can also be complex, and this fact could tell us something about the nature of their frames. If we again take the two possible LPrt frames in (52) into account, we are faced with the following alternatives.

(69) a. **Complex LPrt alternative 1**

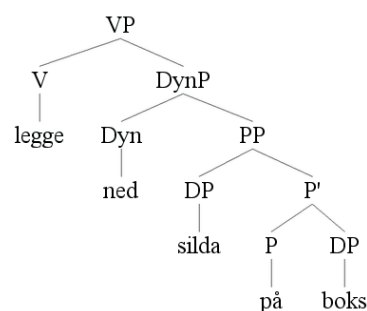

lay down the herring on can

'Lay down (preserve) the herring on can'

¹⁴⁵ For more on "prescriptive syntax" see section 4.6.4.

b. Complex LPrt alternative 2

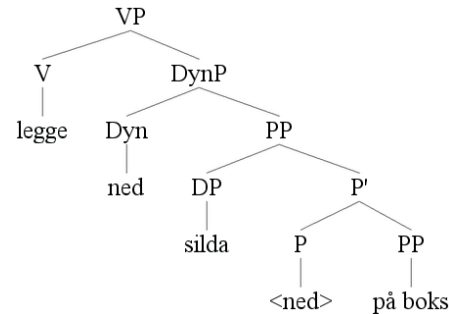

lay down the herring <down> on can

‘Lay down (preserve) the herring on can’

The question is whether there is a complex resultative PP including *ned* ‘down’, or if instead the particle is based outside the resultative PP (in Dyn). *Legge ned* ‘lay down’ with the meaning ‘conserve’ does not need to be “lexicalised” with direct particle insertion in Dyn, as in (69a), but can also be interpreted after particle movement, as in (69b).

On the other hand, the complete resultative frame in (69b) contributes to a more concrete, directional reading of the structure than in the simple counterpart (*legge ned sild* ‘lay down herring’). We should therefore not reject the possibility that the simple *legge ned sild* is structurally different from the complex *legge ned sild på boks*. Note that the theme DP can also be dropped: *legge ned på boks*. The complexity of DynP’s resultative complement can vary.

A reason why the examples in (66) can be inserted in a resultative frame might be that they are somewhere in the grey area between metaphorical and directional, and therefore can take a resultative complement quite easily. Some examples that are more obviously non-directional do not have the same possibility. For example, the constructions in (48) above (the ones describing an end-state, cf. *ete opp maten* eat up the food ‘eat all of the food’, *bruke opp pengane* use up the money ‘spend all of the money’) are clearly non-directional; they have more or less obligatory LPrt, and they cannot have a resultative PP complement. However, in (47) we can more easily add a resultative PP in some of the constructions. So although all the examples in (45)–(48) could be argued to express an accomplishment (of an activity), they differ with regard to the possibility of resultative extension. Therefore, we can continue to consider these examples as belonging to a grey area. In (70), I have added the PPs *på gløtt* ‘ajar’, *i stykke* ‘in pieces’ and *i bitar* ‘in pieces’ to four of the examples from (47). These are

all overt result state manifestations, which fit quite well into this sub-group of *opp* ‘up’ combinations. They harmonise quite well both with LPrt and RPrt frames.

- (70)
- a. lukke {opp} døra {opp} på gløtt.
close {up} the door {up} on ajar
‘open the door ajar’
 - b. ta {opp} glaset {opp} på gløtt.
take {up} the window {up} on ajar
‘open the window ajar’
 - c. dele {opp} kaka {opp} i stykke.
cut {up} the cake {up} in pieces
‘slice the cake in pieces’
 - d. rive {opp} isen {opp} i bitar.
tear {up} the ice {up} in pieces
‘tear the ice into pieces’

This could suggest that the examples in (70) above are based on the frame in (69b), since both particle positions are possible.¹⁴⁶ As discussed in section 4.3.4, there can be insertions that modify (and even semantically “contradict”) a given frame, and in these particular examples, there is a certain friction between DynP and the resultative PP complement. This does not mean that the combination is impossible, only that there is less friction when Dyn is absent (i.e., in the RPrt frame).

How do we know that the RPrt frame and resultativeness go hand in hand, so to speak? Maybe *any* kind of PP in the right periphery is more compatible with the RPrt structure than the LPrt structure, perhaps because the distribution of the particle is influenced by some kind of weight principle? A few searches in the NDC show that this hypothesis cannot be maintained. I will illustrate this with some examples involving instrumental PPs. From the search criteria given in section 2.1.2.2 and the results presented in section 2.1.2.3, there are only three *med* ‘with’ instrumentals, and all of them are combined with LPrt:

¹⁴⁶ This also suggests that the standard examples in (48) are based on the frame in (52a) (DynP → DP), and that the standard examples in (47) are based on the frame in (52b) (DynP → resultative PP).

- (71) a. får bytte ut bilen med sykkel da tenker jeg (Herøy, West Norw.)
 get change out the car with bicycle then think I
 ‘get to change the car with a bicycle, then, I think’
- b. den derre øksa du hogger ut laft med (Rollag, East Norw.)
 this that axe you cut out bond notch with
 ‘this axe with which you cut the bond notch’
- c. så hadde de bygd inn bekken med stein (Karmøy, West Norw.)
 then had they built in the brook with rocks
 ‘then they had cut off the brook with rocks’

These results are also in agreement with my own intuition. If we add an instrumental PP to the right periphery of a directional or a metaphorical VPrt construction, as in (72a) and (72b) respectively, the particle distribution seems to be unaffected.

- (72) a. **Directional:** Eg heiv {+ut} snøen {-ut} med ein spade
 I threw {out} the snow {out} with a spade
 ‘I threw out the snow with a spade’
- b. **Metaphorical:** Eg rekna {ut} tala {*ut} med kalkulator
 I calculated {out} the numbers {out} with a calculator
 ‘I calculated the numbers with a calculator’

Both of these examples are quite clear from my point of view: The well-formedness of the structure is unaffected by the instrumental PP. The instrumental PP is not part of the directional expression; it is rather an adjunct. What about temporal adverbials? Does a temporal element in the right-periphery harmonise better with the RPrt frame? Judged by the NDC results from section 2.1.2.3, it does not. Among the standard constructions, 2 of 26 RPrt constructions have a temporal adverbial (= 7,7%), while the corresponding number for LPrt constructions is 29 of 368 (= 7,9%). In other words, the relative numbers of constructions including a temporal adverbial are comparable.

In sum, I think there is good reason to assume that the RPrT frame is associated with resultativeness, since resultative (but no other) PPs fit significantly better into this frame than in the LPrT frame. In section 2.3, I mentioned that the Lierne speakers from my pilot fieldwork had more or less obligatory LPrT in all standard VPrT constructions; they are probably among the most consistent Norwegian LPrT users. But even these speakers hesitate when the construction is extended with a resultative PP, and some even clearly prefer the RPrT frame in such cases. The reason must be that the Ground element is already established in the RPrT frame, so the resultative PP complement just manifests this frame.

4.4.2 *Constructions with Complex Phrasal Particles*

In section 2.3.2, I discussed another type of complex construction, in which a full phrase can apparently be construed as a particle; in the left-hand position, P and its apparent complement are spelled out as a prosodic unit with the verb (in the relevant dialects). In (73), I repeat Åfarli's (1985: 79) example, and in (74) Sandøy's (1976) examples from Romsdal Norwegian are shown. Åfarli claims free alternation of the particle complex, while Sandøy claims that LPrT distribution is preferred, as is the case with the standard particles.

- (73) Vi sette {på han} hatten {på han}.
 we put {on him} the hat {on him}
 'We put the hat on him'

- (74) a. **Roms. No.:** Han har med å sende {+om bord} detta skaffetyet {om bord}.
 he has with to send {on board} this tableware {on board}
 'He usually sends this tableware on board'
- b. **Roms. No.:** Han kasta {+frå seg} kniven {frå seg}.
 he threw {from REFL} the knife {from REFL}
 'He threw away the knife'

Sandøy (1976: 87ff) gives further examples from Old Norse and the modern Insular Scandinavian languages, while Hulthén (1948: 166f) provides Swedish examples. In other words, these constructions are well established in the Scandinavian languages (except for Modern Danish).

Although (73)–(74) are usually construed as standard (simplex) VPrt constructions with a complex phrasal particle (cf. Åfarli 1985, Svenonius 2003), there is also a semantic similarity between (73)–(74) and the complex constructions discussed in section 4.4.1. In complex constructions, the Ground element is usually extended with a resultative PP, as in (75):

- (75) Vi sette på hatten_{FIGURE} på hovudet_{GROUND}
 ‘We put on the hat on the head’

However, note that in (73), the claimed complement of the particle (i.e., the pronoun) somehow constitutes a semantic Ground element as well. It denotes the place where the Figure is located:

- (76) Vi sette på han_{GROUND} hatten_{FIGURE}
 we put on him the hat
 ‘We put the hat on his head’

Since the nominal can be construed as Ground, it could also be argued to have its base position to the right of the Figure (cf. 4.4.1), but when P is distributed to the left of the Figure DP, the “Ground nominal” cannot be stranded in the right-hand position. Consider (77):

- (77) a. Vi sette hatten på han.
 we put the hat on him’
 b. *Vi sette på hatten han.
 we put on the hat him’
 c. Vi sette på han hatten.
 we put on him the hat
 ‘We put the hat on his head’

(77b) shows clearly that the nominal cannot be separated from the particle. Thus, even if one wanted to claim that the “Ground nominal” *han* is not the complement of the particle (but rather of the Figure DP), it must still cliticise to the particle.

However, there are at least two problems with this approach. First, light pronouns usually cliticise to the nearest host (except sentence adverbials), and here it would have to

cross the Figure DP, *hatten* ‘the hat’, for unknown reasons. Second, constructions like (73)–(74) can be extended with a resultative Ground PP (as in section 4.4.1), which again devalues the status of the light pronoun as a proper Ground. (78) is taken from Alf Prøysen’s classic *Teskjekjerringa* ‘the teaspoon lady’ (which features Hedmark-coloured *Bokmål*):

- (78) Nå hadde kjerringa lagt i vatn klærne i bekken¹⁴⁷
 now had the lady put in water the clothes in the stream
 ‘Now the lady had wet the clothes in the stream’

This should suggest that Åfarli (1985) and Sandøy (1976) are on the right track in classifying the elements in the curly brackets in (73)–(74) as complex particles. I therefore assume *i vatn* ‘in water’ in (78) to be a complex LPrT followed by the Figure DP *klærne* ‘the clothes’ and the Ground PP *i bekken* ‘in the stream’, cf. (79):¹⁴⁸

- (79) Nå hadde kjerringa ...

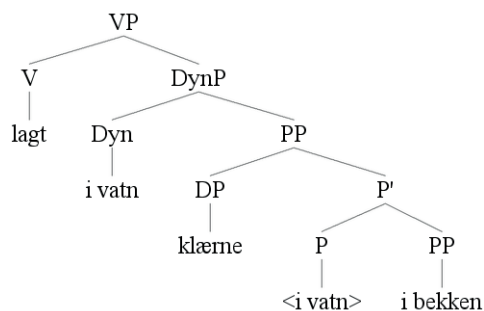

- now had the lady put in water the clothes in the stream
 ‘Now the lady had wet the clothes in the stream’

This leaves the question of how to analyse for complex particles, given that I have argued that the particle constitutes a head, and also that Dyn is a head position. Below I will suggest that the complex phrase-like particle is in fact reanalysed as a head, which is then able to identify

¹⁴⁷ From a 67-year old speaker of the Kvikne dialect (a borderline dialect between Hedmark and Sør-Trøndelag), I got a similar light pronoun example (on November 19, 2014, rendered close to the dialect):

- (i) legge i bløtt dem i mjølk
 lay in wet them in milk
 ‘wet them in milk’

¹⁴⁸ There is also an option that *i bekken* ‘in the stream’ is an adjunct, but if *vatn* ‘water’ is a proper Ground, we must still explain why it can “attach” to the particle.

Dyn, but let us first take a look at Svenonius' (2003) approach to this type of complex particle.

Svenonius (2003: 5) argues for a decomposed PP structure, which distinguishes directional PPs and VPrt constructions from locative PPs. The two former constructions contain a PathP, which is lexicalised by a stressed/prominent P. The entity that moves in VPrt constructions (given a derivational analysis) is the full PathP. Therefore, a full phrase is apparently able to move as a particle, both in Swedish and in Norwegian. (80) is taken from Svenonius (2003):

- (80) Marie satte [på pojken] kläderna.
Marie put [on the boy] the clothes
'Marie dressed the boy'

For Svenonius, particles and directional Ps on the one hand and locative Ps on the other hand lexicalise separate parts of the decomposed PP. The lexicalisation of PathP is always associated with stress. In VPrt constructions, either the particle or the DP complement will be stressed/prominent. The Place head (i.e., the locative preposition) is not stressed.

- (81) [PathP Prt / Dir P [PlaceP Loc P [DP]]]

This kind of analysis should be a possible option within the model I propose here as well; the decomposition of the particle allows it to take a complement. However, I have suggested that the particle can be directly inserted in Dyn, which is a head position, when left-handed. This forces me to consider a technical "reanalysis" of the phrasal particle in (73)–(74) into a head. Given Svenonius' analysis, one must assume that PathP has a special property that licenses this reanalysis. PathP is in most cases realised with a bare particle; I will simply assume that everything which projects within the semantic property PathP is automatically construed as a head. In the left-hand position, the semantic complex is *chunked* into a single terminal syntactic node (cf. Bouchard 1995: 99), namely Dyn. Let us assume that this is the case in examples like (73)–(74). Whenever a phrase is construed as a particle (and spelled out as a prosodic unit with the verb in the relevant dialects), it is syntactically "reanalysed" as a head. This is shown in (82):

- (82) få på plass regelsystemet
 get on place the rule system
 'adapt the new system of rules'

få-på-plass regelsystemet →

få [_{PathP} på_i [_{PP} t_i plass]]_j [_{SC} regelsystemet t_j] →

få [_{DynP} [_{Dyn} [_{Prt} på plass]]] regelsystemet

4.5 On the Mainland Scandinavian Variation

In this section, we extend our perspective to the Mainland Scandinavian (MSc) area. Traditionally, Swedish is claimed to have obligatory LPrt, Danish obligatory RPrt, and Norwegian optional distribution. But our data have shown that spoken Norwegian is syntactically much closer to Swedish than traditionally claimed. Since LPrt is generally preferred in Norwegian standard constructions we must reconsider its position in the MSc context. In the case of Swedish and Danish, I have searched in the NDC with the same search criteria as discussed in section 2.1.2. And the results I got demonstrate clearly that the traditionally claimed patterns are still very much intact.¹⁴⁹ However, Vinka (1999) shows that precative (directional) light pronoun constructions in Swedish can have RPrt,¹⁵⁰ and Svenonius (2010) shows that in North Swedish dialects, the LPrt is not completely obligatory. So although we must take into account that Swedish is more nuanced, let us for ease of exposure follow the NDC and assume a (more or less) obligatory LPrt (at least the tendency is even clearer than in Norwegian).

¹⁴⁹ Consider the search strings (i) and (ii). (i) does not get any Danish results, and (ii) does not get any Swedish results:

- (i) [verb lemma] + 'up'/'down'/'out'/'in' + [noun lemma]
 (ii) [verb lemma] + [noun lemma] + 'up'/'down'/'out'/'in'

As for Norwegian, I searched for full DP constructions in Danish and Swedish, too. In light pronoun constructions, we know from earlier works that there are exceptions from the general Swedish LPrt rule. Hulthén (1948: 159) shows that Skåne Swedish and Finnish-Swedish dialects have RPrt distribution there, and Vinka (1999) also shows that RPrt is generally possible in predicative light pronoun constructions.

¹⁵⁰ As pointed out in section 1.1.2, I will not elaborate an analysis for light pronoun constructions. We could by hypothesis suggest that the particle positions are identical with the full DP constructions. Most speakers of Norwegian distribute the particle to the left of a full DP and to the right of a light pronoun. We can straightforwardly assume that these speakers consistently realise a resultative structure in light pronoun constructions. The question is then whether the speakers who do not have this pattern – i.e., the ones who distribute the particle to the left of a light pronoun – really have another semantic realisation of light pronoun constructions than the former group. And that might be the case. E.g., in Lierne close to the Swedish border in Nord-Trøndelag, my guess is that their (more or less) obligatory LPrt distribution is not semantically different in light-pronoun constructions.

A relevant question is whether the Swedish LPrt construction is similar to the Norwegian LPrt construction, or whether they are structurally and/or semantically different. In Vikner (1987) and Platzack (2010), Swedish and Danish VPrt constructions are claimed to be semantically similar, despite the syntactic deviation. We will see whether this semantic similarity also indicates an underlying syntactic similarity between them. I assume Danish to manifest the resultative RPrt scheme; the main issue in this section will be to launch different solutions for Swedish. Since Swedish is more strictly LPrt-bound than Norwegian, the obvious hypothesis is that Dyn is obligatorily identified. This in turn will suggest that Swedish VPrt constructions are not structural resultatives. We know from Vinka (1999) that Swedish, like Norwegian, do have both directional (predicative) and metaphorical (non-predicative) constructions, so we need to clarify whether this distinction is structurally founded or not, like we did for Norwegian in section 4.3.6.

I will launch three alternatives below. The first one (4.5.1) is a derivational variant and contains an obligatory particle movement from the SC predicate to Dyn. Eventually, I will argue that this is a possible analysis for the directional/predicative variant, but I will reject it for the metaphorical variant, where particle movement is unlikely. However, I will also argue that Dyn is not semantically well-founded for Swedish directional constructions. The second alternative (4.5.2) therefore suggests that the particle does not identify Dyn at all, but that the DP is shifted to the right. This alternative is compatible with Kayne (1985), but generally rejected by Svenonius (1992) and den Dikken (1995). We will also see that it fails on simple syntactic tests. The third alternative (4.5.3) launches my conclusion to the Swedish problem, and here I suggest that Swedish has generated an identical frame as in Norwegian metaphorical constructions, and thus that Swedish VPrt constructions do not have SC structure. My suggestion is that “Dyn” appears with two semantically distinct variants in Swedish, and that one of them is more *res*-like. However, as mentioned, I also open up, somewhat inconclusively, for a possibility where directional, but *not* metaphorical constructions follow the first alternative, with particle movement. I conclude the section in 4.5.4.

4.5.1 Swedish in the Norwegian Frames

The distributional difference between Swedish and Danish has been argued to be derived from Case theory (cf. Vikner’s 1987 discussion on *la* ‘let’ causatives, discussed in section 1.1.3), and also from different realisations of the EPP; in Svenonius (1996a), the Danish and

Swedish difference is explained through different subject positions and particle positions (see section 3.4.3).

However, we can also postulate the difference between Swedish and Danish to be of a semantic character, e.g., that Swedish is reluctant to express true resultativeness. If so, we should expect AP resultatives and perhaps prepositional resultative SCs not to be productive in Swedish, but we know that they are. The following examples are taken from Platzack (2010: 217ff):

- (83) a. Lisa plockade [_{APres} korgen full]
Lisa picked the basket full
'Lisa filled the basket'
- b. Johan nös [_{PPres} näsduken av bordet]
John sneezed the handkerchief off the table
'John sneezed so that the handkerchief blew off the table'

Since Swedish particles are strictly left-bound we could follow Zeller (2001) and argue that they differ from the AP resultatives in that they do not have functional structure, and that they are instead morphologically reanalysed in V^0 (see section 3.5). A problem with the incorporation analysis is that an adverb splits up V and Prt in V2 contexts. The following data are taken from the NDC:

- (84) a. Tiden sträcker inte till (Torsås, South-East).
the time stretches not to
'There is not enough time'
- b. Jag kommer inte ihåg mer (Torsö, central South)
I come not in-mind more
'I can't remember more'
- c. Jag hinner inte med så mycket mer (Våxtorp, South-West)
I manage not with so much more
'I don't manage so much more'

Thus, Swedish *do* have resultatives, and the particle is apparently verb-separate. In cartographic approaches, it is possible to account for verb movement to the V2 position without stipulating an actual excorporation from the particle, e.g., if the particle lexicalises a separate head within the decomposed VP, as in Ramchand & Svenonius (2002). But the obligatorily verb-adjacent particle in Swedish must be accounted for. With the analysis elaborated for Norwegian in section 4.3, we can suggest a movement analysis of the Swedish particle, cf. (85), taken from the NDC (Arjeplog, North Swedish).

- (85) a. Vi ... hade ut nät
 we had out net
 ‘We pulled out the fishing net’
 b. Vi ...

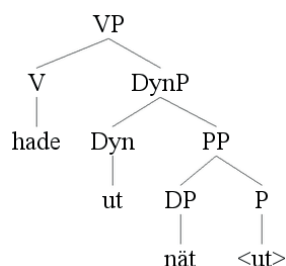

Vinka (1999) shows that we must also account for non-predicative/metaphorical constructions, and they are indeed numerous, as in Norwegian. Let us follow the track from section 4.3.6 and assume that these have a non-predicational structure. (86) is also taken from the NDC (Anundsjö, North Swedish):

- (86) a. skriva upp namnen
 write up the names
 ‘write down the names’
 b.

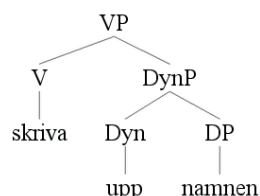

In Norwegian, there is good reason to establish this distinction, since only in the directional case the particle can be extracted (A' moved), and also because it is mainly the directional variant that has a RPrt counterpart. However, since the Swedish particle movement in (86) must be (nearly) obligatory, and since it is construed as a resultative, why should we account for a movement to a dynamic node, or movement at all? In the next sub-section, we will explore the possibility that the Swedish structure is basically predicational, but features a rightward shift of the DP.

4.5.2 *Predicational Structure with Rightward DP Shift*

The semantic dilemma in (86) triggers a second option, namely that the particle does not identify Dyn in Swedish directional constructions, but that the structure itself is a predicational SC – and thus that the DP shifts to the right from the empty subject position. This is compatible with Kayne's (1985) analysis.

- (87) Vi hade [_{SC} ___ ut] [nät]
we had out net
'We pulled out the fishing net'

This is a semantically satisfying solution, but it has some unfortunate syntactic consequences. Svenonius (1992) argues that VPrt constructions do not behave similarly to heavy DP shift, and den Dikken (1995: 47) also poses serious arguments against Kayne (1985). However, there are Norwegian data which actually could lend support to (87). If the DP is adjoined, we should expect a possible adverbial split of the particle and the DP. And this is possible in the following Norwegian examples, where (88a) features a prepositional construction, and (88b) an adjectival construction. At least when the adjective agrees with the DP, a shift is possible (cf. also the discussion in section 3.3.3).

- (88) a. Han kasta ut [til meg] hunden.¹⁵¹
 he threw out of me the dog
 ‘He threw the dog out to me’
- b. Han slo flatt [igjen] jarnet.¹⁵²
 he hit flat._{AGR} again the iron
 ‘He hit the iron flat again’

The obvious prediction now is that Swedish should also allow a split of the particle and the DP, as in (88). In the NDC, I have not found any such examples, but neither have I in the Norwegian part, despite the fact that they are possible. Therefore, I asked three Swedish informants to judge the written examples in (89), and they all unanimously rejected the possibility of a split, whether it was by a PP or an AdvP:

- (89) a. *Han kastade ut [till mig] boken
 he threw out to me the book
 ‘He threw the book out to me’
- b. *Han kastade ut [igen] boken.
 he threw out again the book
 ‘He threw the book out again’

Although the asterisks in (89) are based on only three speakers’ judgements of the written sentences, the judgements were all very clear and done apparently without hesitation. Hence, (89) poses a serious problem for the shift analysis.

¹⁵¹ Den Dikken (1995: 87) (referring to Svenonius 1992) shows that similar examples (i.e., with an intervening instrumental PP between the particle and the DP) are not possible in English. Here, I mainly discuss examples with an intervening resultative, but we saw in section 3.3.3 that constructions with an intervening instrumental are also possible in Norwegian.

(i) Han slo ut med hammaren ein spikar
 he hit out with the hammer a nail
 ‘He hit the nail out with a hammer’

¹⁵² Right-hand adjectives quite often agree with the DP, while the left-hand adjectives more frequently are bare (cf. Heggstad 1931: § 609). If we assume that this particular example actually features a shifted SC subject, we can postulate that agreeing adjectives are always predicates, and that only bare adjectives can identify Dyn. This is compatible with Zeller’s (2001) approach, and the DP shift analysis therefore gives him more credit than we did in section 3.5.

Two empirical observations concerning Swedish, namely the obligatory left-hand surface position of the particle, and the impossible Prt–DP split, lead us to the two following hypotheses:

- (90) a. The syntactic connection between V and Prt is stronger in Swedish than in Norwegian.
 b. The syntactic connection between Prt and the DP is stronger in Swedish than in Norwegian.

If (90b) is true, it might suggest that the DP can only be an adjunct in Norwegian – and maybe also that the DP is always the complement of Prt, as we will suggest in the next sub-section. If (90a) is true, it could lead us to an analysis of Swedish particles as verb-internal, which I however will continue to reject. In Platzack’s (2010: 230) system, the particle is a root (γ) that does not project and therefore must merge with a projecting root, i.e., the root of v . The particle then follows the verbal root to v , so that we get a complex v :

- (91) [_{VP} Han [_v hällde i [_{γP} [_γ <hällde i> [_{DP} mjölken]]]]].
 he poured in the milk
 ‘He poured the milk’

In the case of Danish and the Norwegian RPrT construction, the DP will have to move across the particle, which must be left *in situ*. We saw in section 4.1 through Ramchand & Svenonius (2002) that it is more reasonable to account for particle movement than DP movement. We have also seen that V and the particle split up in V2 contexts in Norwegian, and the NDC reveals this to be true for Swedish too. Some examples:

- (92) a. du spelar inte in det som vi sitter och pratar her? (Bara, South)
 you play not in that that we sit and talk here?
 ‘You don’t record what we are discussing here?’
 b. man ställde alltid upp (Norrarorum, South-West)
 one placed always up
 ‘One would always contribute’

- c. jag växte ju upp på en bondgård (St. Anna, South-East)
 I grew ADV up on a farm'
 'I grew up on a farm'
- d. jag växte ju inn i det hela (Villberga, East)
 I grew ADV in in it all
 'I grew into it all'

These data suggest that Platzack will need to account for an excorporation, as we have seen with other incorporation analyses. The way I see it, Swedish is left with two alternatives: a syntactic separation of directional and metaphorical constructions, as in section 4.5.1, or a semantic distinction between them, as I will outline in the next section.

4.5.3 *Non-Predicational Structures But Different Semantic Nodes*

We established a possible solution in 4.5.1 between directional and metaphorical constructions, where the former has a predicational structure and the particle moves to identify Dyn, while the latter has its particle based in Dyn (cf. the proposed solution for Norwegian in section 4.3.6). However, there is apparently no well-founded reason for movement and Dyn identification in Swedish directional constructions. An apparently better solution could be that the particle in fact moves to identify result state, as in Ramchand & Svenonius (2002) and Ramchand (2008). However, since the opposite order, the predicational SC order, should already express resultativeness, the motivation for this movement can be questioned. I will suggest that Swedish directional constructions have identification of a resultative node, but with a direct insertion. The fact that Swedish full DP constructions are strictly LPrt-bound (see an exception for predicative light pronoun constructions in Vinka 1999) should question why there should be movement from an opposite (and non-existing) word order at all.¹⁵³ Let us assume that the distinction between directional (predicational) and

¹⁵³ There are arguments in favour of a movement analysis posed in e.g. Svenonius (1996a) and Ramchand & Svenonius (2002). And as mentioned in section 4.4.2, Svenonius (2003: 5) argues for a decomposed PP structure in Swedish, which separates directional PPs and VPrt constructions from locative PPs. The two former contain a PathP, which is lexicalised by a stressed/prominent P. This means that the P differs with regard to its internal structure. Yet, the hypothesis that every preposition has a constant G-semantic content (Bouchard 1995) is still compatible with Svenonius approach, given that the primitive semantic elements Path and Place can be chunked

metaphorical in Swedish is a purely semantic distinction, where the particle in the former alternative is directly inserted in a res node (compatible with Ramchand 2008), while the latter has its particle inserted in Dyn, as already hypothesised in 4.5.1:

(93) a. **Directional Swedish constructions**

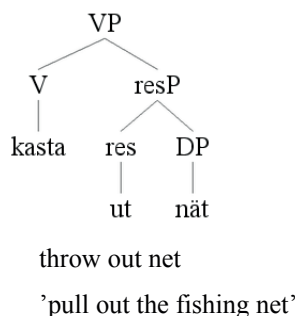

b. **Metaphorical Swedish constructions**

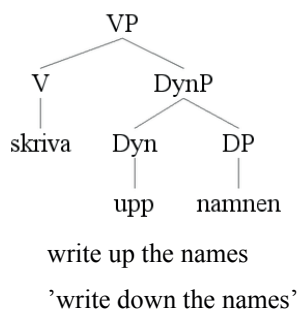

The exact content of res in (93a) can be discussed; the crucial point is that since the syntax between the two relevant full DP constructions is similar (again, see Vinka 1999 for a difference regarding light pronoun constructions), their difference is most likely semantic. (93) suggests that Swedish VPrt constructions are not predicational, i.e., they are not derived from a basic SC structure. Instead, they are semantic resultatives, and therefore only remind

into the single lexical element *i* 'in' (cf. Bouchard 1995: 95). Consider the following pair taken from Svenonius (2003: 5):

- (i) **Dir:** Hoppa i vattnet
'jump into the lake'
- (ii) **Loc:** Hoppa i vattnet
'jump in the lake'

The pair is disambiguated by stress; in (i), *i* 'into' is obligatorily prominent, in (ii) it is non-prominent. Svenonius suggests that the preposition in (i) heads LocP and moves to PathP. (ii) does not have PathP. If we take a contrary assumption, namely that the directional and locative variant of *i* 'in(to)' have the same internal structure, then the difference between locative and directional constructions must be on the P-external sentence level (e.g., ±Dyn), or alternatively on the general-conceptual level.

and I suggest that the particle alternation in written/standard Norwegian can be the result of the meeting of two Grammars: the LPrt pattern of spoken Norwegian and the RPrt pattern of written Danish. I will emphasise that the approach in 4.6 is not fully conclusive. At the moment I consider it an alternative hypothesis for the explanation of the particle alternation, but it needs more investigation.

4.6 A Bilingual Approach to the Norwegian Written Standards

4.6.1 *Micro-Variation as Bilingualism*

In recent years, there has been a massive focus on bi- and multilingualism, and not only in a macro-perspective. As discussed in Vulchanova et al. (2012), dialect speakers can be considered bilinguals, since most speakers are exposed to different dialects on a daily basis, and some are also bidialectal speakers (Nilsen 2005, Indrehus 2014, van Ommeren forthcoming). In Norway, a spoken standard is not relevant for most, but the gap between a given spoken variety and the two written standards is relevant. Vulchanova et al. (2012) measures Norwegian writers' word processing of *Nynorsk* vs. *Bokmål*, and documents a significant difference. The standard of the majority, *Bokmål*, is generally processed faster, but the ones who write both standards regularly, tend to process words faster than the ones writing primarily one of the standards.¹⁵⁵ Thus, we have a situation where the writing of the two standards probably has a measurable bilingual effect. But I will suggest that the syntactic differences between the spoken varieties and the written standards might also qualify as a bilingual situation. Vulchanova et al. (2012) discuss the interference between the written standards, and between different spoken varieties. We will now discuss the VPrt pattern in spoken Norwegian vs. written Norwegian and see if the difference can be construed as syntactic patterns of different languages.

4.6.2 *Spoken Norwegian, Written Norwegian, and Written Danish*

In section 1.1.1, we referred to the claimed free particle alternation in Norwegian as the *theoretically linguistic approach*, while the LPrt preference assumption stems from the

¹⁵⁵ We mentioned in section 1.1.4 that about 87% of the pupils in elementary school have *Bokmål* as their first official language (cf. Almendingen & Søyland 2012: 13). The remaining 13% *Nynorsk* pupils are massively exposed to the other standard in the media, and learn it quite more effortlessly than vice versa.

traditional/dialectological approach. Throughout the work, we have concluded that the latter approach is empirically correct, and we speculated early that the linguistic approach could be derived from the possible patterns in standardised Norwegian. Let us now refer to the free alternation as a pattern found in standard Norwegian (NO_{ST}), i.e., both in *Nynorsk* and in *Bokmål*. And we generalise the data found in Norwegian dialects (NO_{DI}) to claim that spoken Norwegian is a LPrt language. Written Danish (DA) is, as claimed above, basically a RPrt language. In light pronoun constructions, NO_{ST} has obligatory RPrt, while it has either RPrt, LPrt or apparent free variation in NO_{DI}. The data to be taken into account are given below.

- (94) a. **NO_{DI}** (general): Han kasta {+ut} hunden {-ut}
 b. **NO_{DI}** (Central and East): Han kasta {ut} den {ut}¹⁵⁶
 c. **NO_{DI}** (South, West, and North): Han kasta {*ut} den {ut}
 he threw {it} out {it}
 ‘He threw it out’

- (95) a. **NO_{ST}**: Han kasta {ut} hunden {ut}
 he threw {out} the dog {out}
 ‘He threw out the dog’
 b. **NO_{ST}**: Han kasta {*ut} den {ut}
 he threw {out} it {out}
 ‘He threw it out’

- (96) a. **DA**: Han smed {*ud} hunden {ud}
 he threw {out} the dog {out}
 ‘He threw out the dog’
 b. **DA**: Han smed {*ud} den {ud}
 he threw {out} it {out}
 ‘He threw it out’

Now, my hypothesis in the following is that the grammar of (95) is a result of the mix-up and alternation between two separate grammars, namely that of (94) and (96). The full consequence of this hypothesis is that learning to write Norwegian is to be confronted with a

¹⁵⁶ There are indeed some speakers (e.g. in Fosen) who accept both patterns here, but generally East and Central Norwegian speakers will *either* have a LPrt or a RPrt pattern, and not alternate.

Danish system, and by adopting NO_{ST}, one learn to switch between the grammars of NO_{DI} and DA. We will now argue that the Danish grammatical influence on NO_{ST} is quite significant.

Notice also that the idea of particle alternation as the switch between two grammars is not a new one. Hoekstra (1992) and den Dikken (1992: 57, footnote 31) discuss this alternative, but it is rejected by Svenonius (1994: 184, 194). Interestingly, den Dikken's relevant footnote is removed from den Dikken (1995: 27), where the particle alternation is instead explained by the presence vs. absence of a functional projection (see section 3.3.2).

4.6.3 *The Historical Role of Danish in the Norwegian Standard(s)*

From the 14th century onwards, there were different Nordic unions that kept the royal power outside the Norwegian borders, and the Danish language gained entry into Norwegian administrations throughout the 15th century (Torp & Vikør 2003, Indrebø 1947: 30f). As mentioned in section 1.1.4, Danish was written regularly in Norway from the 16th century onwards (Berg 2013: 199ff). For those who were able to read, the Bible and religious texts were central sources found in many households (cf. Fet 2003: 363f). In 1550, the Bible was translated into Danish (Christian III's Bible) and was soon to be the norm for what was considered the correct and dignified language (Torp & Vikør 2003: 120). Berg (2013: 199ff) shows how Danish came into the Archbishopal See of Nidaros (Trondheim) through an archbishop who hired Danish writers. Berg claims that although the Danish, which was written in Nidaros was influenced by Norwegian, it was essentially a Danish language. Danish had the higher prestige. The Norwegian peasants who were able to write also wrote a Danish language (Fet 2003: 378). In sum, I think it is roughly correct to claim that Danish (and Latin) remained the only serious alternative for Norwegian writers between 1500 and 1850. Ivar Aasen's description of the spoken varieties in Norway (1848, 1850) and eventually the standardisation of the *Nynorsk* language (1853, 1864, 1873), which was officially put on equal footing with Danish/*Bokmål* from 1885, remain the most important contribution of language documentation in the history of Modern Norwegian. When the *Bokmål* standard was norwegianised from 1907, by adopting morpho-phonological principles corresponding to the urban upper class spoken Norwegian, we could in principle recognise two separate Norwegian standards, with their different bases. In section 2.1.1, I mentioned an important note from Aasen (1864: § 334). Here, he claims the RPrt distribution to be unnecessary in spoken Norwegian; in a spoken resultative construction, a prominent LPrt is appropriate. But

in the written context, Aasen recommends to use RPrT in the resultative cases in order to disambiguate it from the standard LPrT frame. This was in other words an invitation and encouragement to use the Danish pattern already familiar to the Norwegian writers of Danish – a meeting on the halfway, so to speak.¹⁵⁷

4.6.4 Prescriptive Syntax

The light pronoun constructions are not commented in Aasen (1864), but as mentioned in section 1.1.4 they are given a note in his descriptive grammar (Aasen 1848), where the LPrT pattern is claimed to be the pattern for East and Central Norwegian. In Western (1921: § 454), LPrT + light pronoun is rejected in *Bokmål/Riksmål*, despite the admittance that it is found in the dialects. Thus, it is quite clear that Danish has had its impact on the particle distribution found in the written standards, which are both distinct from the general system found in the dialects. The pattern found in (95), i.e., “free” alternation in the full DP construction and obligatory RPrT in the light pronoun construction, is partly the result of a prescriptive syntax.

Other similar examples are the never-split-an-infinitive rule, and the obligatory V2 in interrogatives. Infinitives never split in Danish, but the general rule in spoken Norwegian is a full split (the NDC provides results from all over the country with e.g. *å* ‘to’ + *ikke* ‘not’ + infinitive). Faarlund (2003: 73) claims that the split infinitive is a novation from the 20th century, but it goes clearly further back. It is attested in the early years of written *Nynorsk* in the 19th century,¹⁵⁸ which means that it was probably well established in NO_{DI}. Contrary to

¹⁵⁷ The discussion in section 4.6.3 can also be compared to the Danish influence on Faroese. In section 1.3.5, we had a short discussion on the role of language external factors, and e.g., whether the RPrT preference in Faroese could be seen in connection with the Faroes’ close relationship to Denmark over the centuries (see Sandøy 1974, Skomedal 1980, and 1.3.5 for more details).

To take another example, we know that the easternmost dialects in East Norway and in Trøndelag have the most consistent LPrT pattern (both in full DP and in light pronoun constructions). The LPrT light pronoun constructions were more widespread in Aasen’s (1848) time. The dialects which have not adapted to standard Norwegian today are distant from their regional capitals Oslo and Trondheim, *and* they are close to Sweden. Thus, the patterns reflect the different contacts and influences in the respective regions.

On a general level, language contact as a trigger of “coincidental” co-variation is perhaps an underestimated factor in traditional generative grammar. As noted by Newmeyer (2006: 5), the Mainland and Insular Scandinavian languages have been in contact for centuries, and the speakers of the latter group learn Danish as the second language in school, and/or in many cases speak one or another variety of MSc. The fact that structural variation between closely related languages can be the result of coincident, external factors, is in turn an argument for Newmeyer against doing micro-comparative work with a macro-parametric ambition.

¹⁵⁸ Two split-infinitive examples from the early written *Nynorsk*:

- (i) Regnet og Nordanvinden, for at ikki tala om Vintren, ...
the rain and the north wind, for to not talk about the winter, ...
‘The rain and the north wind, not to mention the winter, ...’
(Aa. O. Vinje (d. 1870): *Skrifter i samling* II,243).

Faarlund, the historical linguist Ivar Berg (in personal talks) thinks the split infinitive goes way back in spoken language and might have been kept alive by unsteady Dano-Norwegian writers (who have trusted their L1 grammar). This would be compatible with Berg's (in press) observation that the least steady of late medieval writers "revealed" themselves by using syntactic patterns from their dialects rather than from Danish. Finally, in the 19th century, the split infinitive has probably been revitalised in writing, with the appearance of the *Nynorsk* standard.

In Faarlund et al. (1997: 996ff), the split is classified as more or less optional, but with the admittance that many speakers prefer the split. I think this is true when it comes to the writing of NO_{ST}, but it is an understatement for NO_{DI}. However, the never-split-an-infinitive rule has probably never stood strong for steady *Nynorsk* writers. Heggstad (1931: § 453) and Beito (1970: § 358) claim that a negation (e.g. *ikkje* 'not', *aldri* 'never', *ingenting* 'nothing') generally splits the infinitive. Despite of this, there is no doubt that many writers still obey the non-split rule. Therefore, it must come from other conventions than from the rules manifested in NO_{DI} and *Nynorsk*. My claim is that Danish (and *Bokmål*) is that convention.¹⁵⁹ Heggstad (1931) emphasises in the preface that he will be explicit in the book whether he discusses written or spoken language. That is not the case in the above-mentioned infinitive section, but my guess is that he is describing the practice of the *Nynorsk* writing.

Interrogative V3 is another typical example of a common structure in NO_{DI} in large parts of the country, which is not accepted in NO_{ST} (Eide & Åfarli 2007: 133).¹⁶⁰ The Norwegian V2 rule is thus clearly overgeneralised. Alternatively, NO_{ST} has also in this case adopted the Danish pattern, where V2 is obligatory. In sum, we have several examples of syntactic patterns that are well represented in NO_{DI}, but which either have been or are still neglected in the written standards. Thus, there is good reason to separate between prescriptivism and descriptivism also within syntax. Syntactic prescriptivism has been important both in the *Nynorsk* (e.g., Aasen 1864, Heggstad 1931, Beito 1970) and *Bokmål* (e.g., Western 1921) grammars over the years.

-
- (ii) Mange av dem saag ut til aa ikkje bry seg ...
 many of them saw out to to not care ...
 'Many of them didn't seem to care ...'

(Arne Garborg: *Skriftir i Samling* 1,36, from *Bondestudentar* (1883).

¹⁵⁹ In *Språknytt* (1991, vol. 2: 19), it is explicitly claimed that Adv-Inf. marker-V is the general order for *Bokmål* (and Danish), while Inf. marker-Adv-V is the general order for *Nynorsk* and spoken Norwegian (and Swedish). The statement is made as an answer to a question from a reader, who believes that the split infinitive is wrong. See also Aa (2014) for a brief discussion on the Norwegian split infinitive.

¹⁶⁰ See also Rognes (2011), who shows that at least V3 and V4 are accepted in interrogatives in the Rogaland dialects (South-West Norwegian).

4.6.5 Particle Alternation as the Result of Parallel Grammars?

Eide & Áfarli (2007: 134) makes an important note regarding the interrogative V3 speakers – namely that they are able to *switch* with the V2 order. Their examples are taken from the Halså dialect of Nordmøre:

- (97) a. Kåin lika du best?
which like you best
'Which of them do you like the most?'
- b. Kåin du lika best?
which you like best
'Which of them do you like the most?'

A Halså dialect speaker is able to produce both these variants. However, free option is not compatible with modern generative theory, where grammars are instead assumed to be deterministic. Eide & Áfarli's solution to the apparent optionality is thus that V3 represents the local dialect grammar, and V2 represents the standard grammar – and a Halså dialect speaker is able to switch between these two grammars. Given Vulchanova et al. (2012) and Roeper's (1999) approaches, the dialect speaker is thus bilingual. Roeper (1999: 2) defines bilingualism in the following way:

[Bilingualism] is present whenever: Two properties exist in a language that are not stateable within a single language.

As claimed above, NO_{ST} mainly consists of two written standards (also with two different grammars), which are not usually spoken (except to some extent in national broadcasting). The interesting part, when it comes to the VPrt constructions, is the "free" particle alternation (claimed by the theoretically linguistic literature), which in case must be generalised from NO_{ST} (and *not* NO_{DI}), cf. (95a). Taking Torp & Vikør (2003: 114) into account, we can assume that Norwegian children have been able to write on an instrumental level since the late 19th century. This means that they at least from then on have adapted a grammar separate from their L1 (NO_{DI}). Learning to write one (or both) of the Norwegian standards is adopting

a second grammar separate from one's L1, and which is syntactically flavoured by the written Danish grammar.

Writing Norwegian today is thus to master the conventions of a syntax based on both NO_{DI} and Danish. When we take this into account, the alternation in (95a) can be considered a switch between these two separate and deterministic grammars, so that it is a grammar alternation rather than a particle alternation. In that case, the apparent free alternation found in NO_{ST} is the result of bilingualism. Steady NO_{ST} writers have a high knowledge of their L1 (NO_{DI}) and DA(nish), and therefore NO_{ST} can essentially be captured as follows:

- (98) NO_{ST} = the knowledge of and competition between the systems of NO_{DI} (LPrt) and DA (RPrt).¹⁶¹

Given (98), we can relate the shift between NO_{DI} and NO_{ST} to Roeper's (1999: 12ff) idea concerning the shift between social registers.

4.6.6 Conclusion

In sum, I think it can be fruitful to interpret the Norwegian particle alternation as a result of bilingualism (cf. also Hoekstra 1992 and den Dikken 1992), given the strong influence Danish has had on written Norwegian, since it was the only serious written Scandinavian alternative in Norway for centuries. As noted by Vulchanova et al. (2012), there is much research to be done concerning the multilingual effect from the exposure of all the different dialects in Norway. There is also work to be done concerning the bilingual effect of adopting a written standard, which is syntactically divergent from one's L1. There is no space for such a study here (only the hypothesis), but hopefully section 4.6 can contribute with some research ideas.

¹⁶¹ (95b) is also interesting in this respect. In light pronoun constructions, LPrt is impossible in both standards, possibly because it is not Danish enough. But in the case of *Nynorsk*, maybe it is also because it is not West Norwegian enough (if the West Norwegian syntax has been the norm for the *Nynorsk* grammar in this case). The interesting part here is that the eastern East and Central Norwegian speakers must adapt a system separate from their L1 grammar.

4.7 Conclusion

In this chapter, I have developed an analysis of Norwegian verb-particle (VPrt) constructions based on the data in the first sections of chapter 2 (2.1–2.3). The two most important empirical observations upon which this chapter is based are a rejection of the hypothesis of optional particle distribution in Norwegian (99a), and the notion that there is a semantic difference between left-handed (LPrt) and right-handed (RPrt) constructions (99b):

- (99) a. LPrt and RPrt are not distributed optionally in Norwegian; LPrt is generally (and by most *clearly*) preferred.
b. The meaning of a given LPrt construction is different from that of the corresponding RPrt construction.

In section 4.1, I argued in line with traditional generative approaches that DP–Prt should be adopted as the basic order, and that the preferred LPrt order is derived using semantically driven head movement to a verb-adjacent *Dyn(amic)* node. In turn, the identification of *Dyn* makes it possible to separate a group of metaphorical/idiomatic VPrt constructions from the directional/predicational constructions. In section 4.3.6, I suggested that the difference between (100a) and (100b) can be formalised using particle movement in a predicational structure for the former, and direct insertion of the particle in *Dyn* in the latter. The metaphorical reading can be obtained through idiom formation in Bruening’s (2010: 531ff) sense.

- (100) a. Johan kasta [_{DynP} ut [_{PP} hunden <ut>]].
John threw {out} the dog {out}
‘John threw the dog out’
b. Johan tenkte [_{DynP} ut [_{DP} planen]].
John thought out the plan
‘John worked out the plan’

In section 4.3, I challenged the traditional derivational approaches by introducing a representational model, in which the structure is the primary carrier of meaning and gets further modified by the lexical elements inserted into the structure as well as by general world knowledge, i.e., general-conceptual semantics. I discussed quite a lot of data that illustrated

the importance of all these three levels. I suggested a division between directional and metaphorical LPrt constructions as illustrated in (100). I took (100a) to suggest that RPrt and directional LPrt constructions are predicational, but I also claim that the predication is weakened in the LPrt alternative, and that the Figure DP is thus devalued as a subject. The syntactic tests from Taraldsen (1983) suggest that there is a difference with regard to predication in LPrt and RPrt constructions. The non-predicational analysis in (100b) can formalise a significant difference between the two alternatives in (100).

I ended the chapter by looking at the micro-variation in the Mainland Scandinavian area from two different perspectives. In 4.5, I presented three alternatives for explaining the Swedish particle distribution, given that (99) is true. In 4.6, I launched the idea that the particle alternation found in (written) Norwegian is the result of the mix-up of two separate grammars, namely that of spoken Norwegian and written Danish. The idea that the particle alternation reflects two separate grammars is originally taken from Hoekstra (1992) and den Dikken (1992).

In the next chapter, I will take the basic analyses depicted in (100) to a new level by including more and earlier unexplained data. We will then explore the full consequences of the ideas developed in section 4.3. By adopting a representational model, where LPrt and RPrt constructions are derived by lexical insertions into separate frames, it forces us to reconsider the italicized questions under example (1) in section 1.1.1 (*What is the basic word order? How are the two alternative word orders derived?*). The new questions which emerge from the present chapter and will be important for the next chapter are the two following: *What differences are structurally founded? What differences can be linked to the general-conceptual domain?*

Concerning the research questions (RQs) from section 1.1 (summed up in 1.5), this marks a shift from RQ 2 to RQ 3:

RQ 2: What is the nature of the syntactic structure and derivation regarding Norwegian VPrt constructions?

RQ 3: How can the interplay between structural, lexical and non-linguistic meaning best be integrated in an analysis of Norwegian VPrt constructions?

5 More Norwegian Verb-Particle Constructions

In this chapter, I will explore the model and ideas developed in section 4.3 by including some lesser known but nevertheless still important properties of Norwegian verb-particle (VPrt) constructions and other structures with which they interact. In section 2.4, I presented a group of VPrt constructions that apparently does not allow RPrT distribution. Ven (1999: 47ff) refers to these as Group 2 VPrt constructions, in contrast to Group 1, which encompasses the standard types discussed in chapter 4. Although many of the (especially metaphorical) standard constructions also have restrictions on RPrT distribution, the Group 2 constructions are completely impossible with RPrT. Group 2 constructions are of the type *ta {av} bordet* ‘{*av} take {off} the table’ ‘Clear the table’, and to my knowledge they have not been discussed much other than by Ven (1999).

In section 5.1, I will identify Group 2 as non-predicational, in contrast to Group 1 (cf. chapter 4), which are predicational (at least the directional constructions). Then in sections 5.2–5.4, I will consider unaccusative VPrt constructions, which on the surface look like the Group 2 constructions, but which are really quite different. Unaccusative VPrt constructions have not been discussed in previous approaches to my knowledge, and therefore 5.2–5.4 are crucial sections in this thesis. In 5.2, I will discuss the unaccusative structure in a derivational model. Then in 5.3, I will consider the data in a representational model with direct particle insertion in Dyn. Finally, 5.4 provides more data (weather constructions), and 5.5 concludes the chapter.

5.1 A Second, Non-Predicational Group of VPrt Constructions

5.1.1 Two Groups of VPrt Constructions (\pm Predication)

I will begin by assuming that the grammatical difference between Group 1 and 2 is that only the former is truly predicational. I argued in section 4.3.8 that directional LPrT constructions of Group 1 have their predication weakened, and I also argued in 4.3.6 that \pm predication is a criterion that can separate directional from metaphorical constructions (there are good syntactic reasons to do so, such as their differing extraction possibilities). My claim is that Group 2 constructions do have particle identification of Dyn, but lack a grammatical SC

subject completely; the subject is not merely devalued but truly absent. Group 2 then differs from Group 1 with regard to predication, and it also differs from ordinary directional PPs with regard to P's identification of Dyn.¹⁶²

I will start by assuming a structural difference between Group 1 and 2. Examples of Group 2 constructions are given in (1):

- (1) a. ta {av} bordet {*av}¹⁶³
 take {off} the table {off}
 'clear the table'
- b. skrape {av} ruta {*av}
 scrape {off} the windshield {off}
 'scrape everything (ice) off the windshield'

In both these examples, V + P are pronounced with a single word accent in the relevant dialects (see section 2.2). Hence, there is a prosodic argument for construing them as VPrt constructions. But unlike in Group 1 constructions, the DP cannot be a SC subject in any of the examples. Instead, one can imagine something (food) being taken off the table in (1a), and something (ice) being scraped off the windshield in (1b). Some VPrt constructions of this type form minimal pairs with locative PPs. Only the VPrt variant, and not the locative PP, has the word accent spell-out of V + P.

- (2) a. ta [_{Prt} på] bordet — set the table
 b. ta [_{PP} på bordet] — touch the table
- (3) a. ta [_{Prt} av] bordet — clear the table
 b. ta [_{PP} av bordet] — take (steal) (something) from the table

¹⁶² In section 5.2.2, I will even discuss the possibility that all LPrt constructions are non-predicational given a representational model. Then directional and metaphorical Group 1 *and* Group 2 will be structurally identical and instead differ on a general-conceptual level.

¹⁶³ If the DP is interpreted as Figure, and not Ground, RPrt is possible in (1a, b). (1a) will mean to lift the table off (e.g., from a cabin wall), and (1b) to scrape so much that the windshield itself loosens. These are Group 1 interpretations, and are irrelevant for the Group 2 interpretation.

In the standard Group 1 type construction, the particle can move across the Figure DP. However, in (1), (2a) and (3a), there is no Figure, but rather a Ground DP, which is presumably located lower in the structure.

A straightforward analysis of Group 2 could be to stipulate a covert SC subject (marked with *e*) (Figure), and account for movement of a transitive P to Dyn.

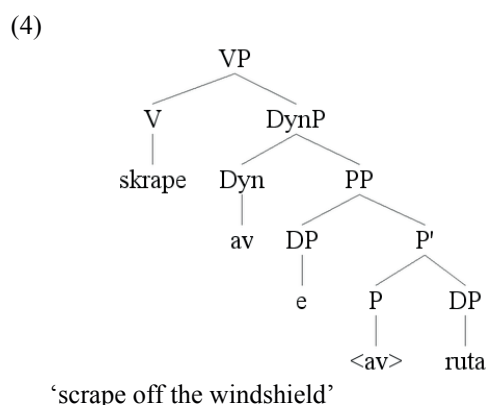

The particle movement indicated here does not affect the surface word order (since the SC subject position is empty), but there are still reasons to assume an identification of Dyn. First, there is the prosodic argument mentioned above (*skrape* + *av* are spelled out as a prosodic unit). Second, and more importantly, consider the minimal pairs in (2) and (3). The PP in (3b) is ambiguous: The most conventional interpretation is that it expresses a continuous or iterative action (e.g., if more items are taken from the table continuously), but it can also express a single directional action (e.g., if one particular item is stolen). And since (3b) can be construed as directional, (3a) is probably not an “ordinary” directional PP. However, Svenonius (2003) diagnoses similar constructions (as (3a)) in Swedish as directional PPs, based on constituency tests and the fact that a particle, but not a directional P, can incorporate into a participle. It is important to notice that the participle incorporation possibilities are quite different in Swedish than in Norwegian. In Swedish, incorporation is obligatory in many dialects,¹⁶⁴ while in Norwegian there is variation between impossible, possible and preferred incorporation (cf. Sandøy 1988, Svenonius 1996a). Hence, it is hard to diagnose a particle based on this criterion in Norwegian. We should probably also not reject the possibility that a

¹⁶⁴ Vinka (1999: 353) notes that non-predicative particles obligatorily incorporate into the participle, while predicative particles may be separated from the participle.

directional PP in one language might be realised as a particle in another language. My hypothesis is therefore that there is particle shift in (3a), shown in the structure in (4).

However, there is an unexplained problem with (4). Is it reasonable to assume obligatory particle movement, when that same movement is impossible with an overt SC subject?

- (5) skrape {*av} isen {av} ruta
scrape {off} the ice {off} the windshield
'scrape the ice off the windshield'

As we have already seen, there is an asymmetry between Group 1 and Group 2 constructions, and in (5) we see a strong indication that this asymmetry should be explained more clearly based on the structural representation. The empty subject position indicated in (4) is stipulated; and (5) reveals that the ice is not structurally represented in (4), but rather conceptually.

This finding relates to Hoekstra's (1988: 117) notion of *shadow interpretation*, which concerns the interplay between what is conceptually given and what is structurally given. In resultative SCs, the predicational relation between the Figure DP and its predicate is sometimes shadowed by an apparent semantic – but not structural-semantic – verb–object relation between the matrix verb and the post-verbal DP (i.e., the SC subject). Consider (6) and (7):

- (6) a. He hammered the metal.
b. He hammered [_{SC} the metal flat]
- (7) a. *He drank the fridge
b. He drank [_{SC} the fridge empty]

In the transitive (6a), *the metal* is the object of the hammering. Since we easily conceptualise that metal can be hammered, *the metal* is likely to be shadow-interpreted as the object of the verb in (6b) too, although it features in a structural predication relation with the adjective. And this is the essence of Hoekstra's term: A shadow interpretation can be characterised as an interpretation based on general conceptions rather than the structural relations. It is highly probable that the metal is hammered in (6b), but it is not absolutely certain, and it is not given

by the structure. The structure only makes it clear that the metal gets flat as a result of the hammering. But the actual object of the hammering is not clear. Note that it is a possible interpretation that something else is hammered (e.g., a brick on top of the metal) in order to get the metal flat. Our world knowledge would probably suggest direct hammering of the metal, but the important point is that the structure does not make this explicit.

In (7b), we are not misled by a corresponding shadow interpretation, since we usually (in a normal world) do not conceptualise a fridge being drunk by someone, cf. (7a). The fact that the fridge is an impossible object of the drinking prevents an object interpretation of the fridge in (7b) too. Thus, the (un)grammaticality of the a-versions above forms the basis of the (im)possibility of a shadow interpretation in the b-versions.

In a similar manner, food and ice, respectively, are usually associated or conceptualised with (1a, b); they fill the semantic role as if they were covert SC subjects. However, (5) indicates that a covert representation of *isen* ‘the ice’ cannot be part of the structure in (1b) (since it makes the verb-adjacent particle impossible). But since we have general world knowledge of its presence, so to speak, it is still interpreted as an essential part of the conceptualised action. It is shadow-interpreted as SC subject.

Shadow interpretations are obviously quite common in language. The notion of shadow interpretation can be directly related to the discussion of Bouchard’s (1995) G- and S-semantics in section 4.3.4. We must assume that there is no one-to-one relation between what is conceptualised on the basis of world knowledge and what is part of the actual structure, or alternatively where it belongs in a given structure. Shadow interpretation amounts to the blending of S-semantic factors with the G-semantic representation. In (6b), the G-semantic SC subject is potentially (and most likely) also interpreted as an S-semantic object of the verbal action. And in (1a, b), the food and the ice are not present on the G-semantic level at all, but are still essential ingredients on the S-semantic level.

In sum, there are prosodic, semantic and syntactic arguments for classifying (1), (2a) and (3a) as VPrt constructions, with the consequence that they must be considered non-predicational (subjectless). Group 1 and 2 can thus be depicted as follows:¹⁶⁵

¹⁶⁵ (8a) only shows one of the possible LPrt frames from Group 1. In section 4.3, I suggested that metaphorical LPrt constructions are non-predicational, with direct particle insertion in Dyn (and with DynP taking a DP complement). I also suggested that DynP is not present at all in the RPrt frame.

(8) a. **Group 1**

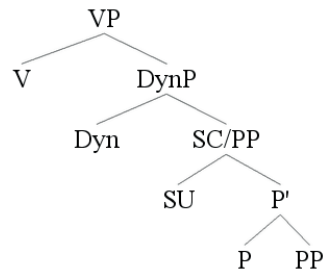

b. **Group 2**

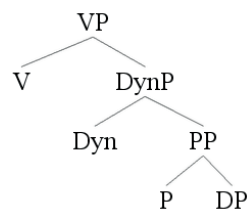

The pair in (8) provides a more direct and economical representation of the two VPrt groups. We can assume that an overt SC subject is needed in order for a VPrt construction to be truly predicational. But the $\text{Dyn}^0\text{-P}^0$ configuration is identical in (8a, b), with no intervening head position in either of them.

The proposal of two different VPrt structures in (8) above should be uncontroversial. The generation and identification of Dyn triggers a different semantic reading from a structure where DynP is not generated, but there is no reason to believe that Dyn should dictate the internal structure of its complement, as we saw in section 4.3.3. To the contrary, the case for the presence of DynP is strengthened if Dyn is able to take both predicational and non-predicational complements.

The possibility of taking different types of complements is of course not unique to Dyn. Verbs can take both DP and SC complements, as in (9), and the preposition *med* ‘with’ has a similar property (Jespersen 1924, 1940, Beukema & Hoekstra 1984, Aa 2004, 2006), shown in (10), which will be discussed in chapter 6. The two VPrt groups are shown in (11).

- (9) a. ete [_{DP} frukost]
 ‘eat breakfast’
 b. ete [_{SC} kjøleskapet tomt]
 ‘eat the fridge empty’

- (10) a. Han slo med [_{DP} ein hammar].
 ‘he hit with a hammer’
 b. Mattis sat på land med [_{SC} tauenden i handa]
 ‘Mattis sat on the shore with the rope-end in his hand’
- (11) a. dekke [_{DynP} på [_{PP} <på> bordet]]
 lay on the table
 ‘lay the table’
 b. kaste [_{DynP} ut [_{SC} hunden <ut>]]
 ‘throw out the dog’

However, there is still an unexplained problem with the Group 2 representation: the transitive P in (5) is not able to move. *Skrape {*av} isen {av} ruta* looks like a standard resultative V + SC construction, and the impossibility of movement indicates an absence of DynP. In (8a), I suggested that a similar transitive preposition became particle-like by moving to DynP, but (5) could suggest that movement of a transitive preposition is problematic. There is no apparent reason why this should be so, especially since a transitive verb is generally assumed to move. In a traditional GB analysis, Case can be licensed on a DP by a V trace in Norwegian, but not by a P trace:

- (12) Johan skrapa_i heldigvis t_i ruta.
 John scraped luckily the windshield
 ‘John luckily scraped the windshield’
- (13) *Johan skrapa av_i isen t_i ruta.
 John scraped off the ice the windshield
 ‘John scraped the ice off the windshield’

Given a derivational analysis, I must stipulate a separate rule for the licensing of DPs by prepositions as opposed to verbs; the sentence-final DP is not licensed correctly in (13). Call this the *PP Integrity Hypothesis* (PPIH): “A DP cannot be licensed by the trace of a P.” The PPIH is an *ad hoc* rule to describe a difference between V and P.

Now, consider a representational analysis with no P movement, but instead with P directly inserted in the left-hand position (Dyn):

- (14) *Johan skrapa [_{DynP} av [isen ruta]].¹⁶⁶
 John scraped off the ice the windshield
 'John scraped the ice off the windshield'

Given this representation, the crash is straightforwardly explained because the P cannot license two DPs. The representational model thus explains the crash with a general rule whereas the derivational model needs an *ad hoc* stipulation to do so. This clearly favours the representational model.

In fact, there is also a more economical way of distinguishing between the minimal pairs in (2) and (3), given a representational model. I repeat (3) here.

- (15) a. ta [_{Prt} av] bordet
 take off the table
 'clear the table'
- b. ta [_{PP} av bordet]
 take off the table
 'take (steal) (something) from the table'

The prosodic and semantic difference between these structures can be accounted for by one simple difference: The DP is the complement of Dyn in (15a), corresponding to (16a), and of P in (15b), corresponding to (16b).

¹⁶⁶ These can also be generalised as typical examples of locative alternation (e.g. Rappaport & Levin 1985, 1988. For an extended list of references, see Levin 1993: 49f). This particular example fits in Levin's (1993: 51f) group of transitive *clear* alternation constructions. Note that *Johan skrapa av ruta is* 'John scraped off the windshield ice' is possible, i.e., that the Ground DP can precede the Figure DP. Apparently this should also fail for Case reasons, but I must assume that the Figure (*is* 'ice') is correctly licensed by V and the Ground (*ruta*) by P. Given this, it seems that P must still license an adjacent DP, as in the latter example. P + Ground are non-adjacent in (14). The verb can license the Figure DP correctly from its trace in both examples. I will not elaborate upon the locative alternation here, but I refer the reader to Levin (1993) for a great empirical overview and numerous further references.

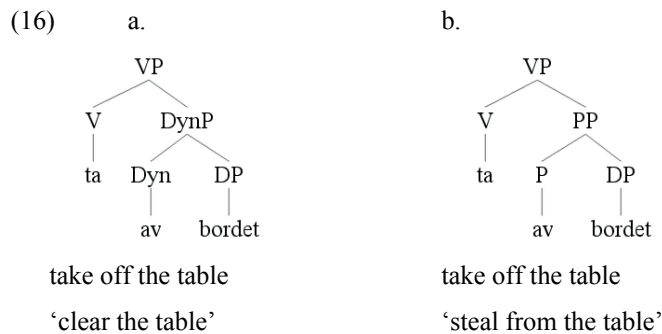

This is a minimal way of construing the difference between a VPrt construction and a transitive PP. (16a) is also appropriate for Group 2 since I have argued that examples of this type are non-predicational.

However, if the frame in (16a) is reserved for Group 2 constructions, I must reconsider what was said in section 4.3.6. There, I suggested that the metaphorical interpretation of *køyre ut posten* 'distribute the mail' and the directional interpretation 'drive out the mail (with a car)' were structurally different. The metaphorical variant had a representation similar to (16a), while the directional LPrt construction was derived by particle movement. The two relevant structures are repeated in (17).

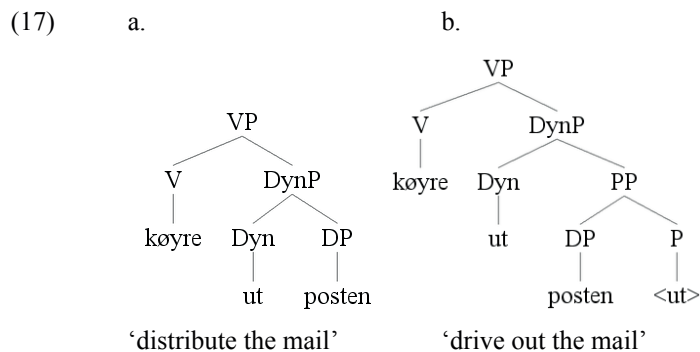

Since the structure in (16a) is identical to (17a), let us assume that (17b) is the standard representation for all Group 1 LPrt constructions. If that is the case, the directional and metaphorical readings of (17b) must be S-semantically founded. This entails a predicational representation for all Group 1 constructions. Although the predication is weakened in LPrt constructions and harder to trace in metaphorical constructions, there is still a difference between the transitive (18a) and metaphorical (18b) LPrt constructions:

- (18) a. lese boka
 ‘read the book’
 b. lese ut boka
 read out the book
 ‘finish the book’

I stated above that the book certainly does not become ‘out’ as a result of the reading; given DynP and the most conventional S-semantic information, this interpretation is excluded. However, the basic semantics of *ut* ‘out’ is resultative; we can assume this to be weakened, but still not completely absent, after the identification of Dyn. If it were completely absent, (18a) and (18b) would probably be interpreted more similarly. Until further notice, I assume that movement to Dyn in (17b) weakens the structural predication.¹⁶⁷

5.1.2 A Preliminary Typology of VPrT Constructions

In this section and the two previous ones, I have discussed several different particle and non-particle constructions that are related in one way or another. This is therefore an appropriate stage to provide a preliminary summary and typology of the constructions discussed so far. In the next section, I will continue with a discussion of unaccusative constructions and thus extend the application of the schema that is given in (11), but first I will emphasise the differences and similarities between the constructions discussed in sections 4.3 and 5.1. The two key words here are *dynamisation* and *predication*. The four main related groups of constructions apparently differ from one another in (i) whether they have DynP or not, and (ii) whether they are predicational or not. The groups are shown in (19), and their respective basic structures in (20).

¹⁶⁷ If one assumes direct insertion of *ut* ‘out’ in Dyn, it is not possible to relate the difference between (18a) and (18b) to structural predication. In section 5.2, I will again consider the possibility that all constructions with a left-hand particle (Group 1, 2 and unaccusatives) have the structure in (17a) after all. Then Group 1 does not involve weakening of structural predication, but rather weakening of the lexical semantics of *ut* when inserted in Dyn. Furthermore, the separation between directional and metaphorical LPrT constructions will be S-semantically founded.

(19) Preliminary VPrT typology

| | +DynP | -DynP |
|--------------------------|--|--|
| +Predication (SC) | Group 1 LPrT constructions (directional and metaphorical, standard and complex)¹⁶⁸ <i>Kaste ut hunden (i hagen)</i> 'throw out the dog (in the garden)' <i>Rekne ut prisane</i> calculate out the prices 'calculate the prices' | RPrT constructions (directional and metaphorical, standard and complex) <i>Kaste hunden ut (i hagen)</i> 'throw the dog out (in the garden)' <i>Skrø lyden opp</i> 'turn the volume up' |
| -Predication | Group 2 constructions <i>Ta av bordet</i> take off the table 'clear the table' <i>Ta på bordet</i> take on the table 'lay the table' <i>Skrape av ruta</i> 'scrape off the windshield' | Standard V + P constructions (locative, directional, and iterative) <i>Ta av bordet (steal)</i> take off the table 'steal from the table' <i>Ta på bordet</i> take on the table 'touch the table' |

(20) The basic structural representations

a. +Predication, +DynP

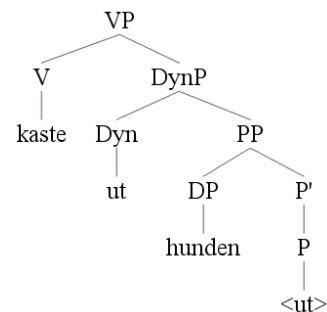

'throw out the dog'

¹⁶⁸ The predication in this group is weakened, but still present.

b. +Predication, –Dyn

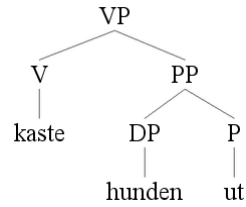

'throw the dog out'

c. –Predication, +Dyn

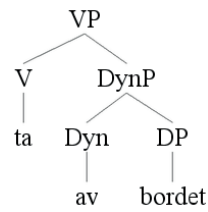

take off the table

'clear the table'

d. –Predication, –Dyn

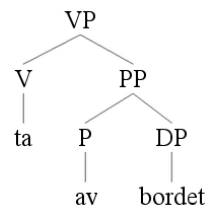

take off the table

'steal from the table'

5.2 Unaccusative VPrt Constructions

5.2.1 Unaccusative VPrt Constructions as Predicational?

In section 2.5, I claimed that constructions in which the particle combines with an unaccusative verb look similar to Group 2 constructions (with obligatory LPrt) on the surface, but that they are really quite different. I will now discuss whether this is true or not. First, let

me make clear that the term *unaccusative* refers to what are usually referred to as unaccusative verbs, distinguished from unergative verbs since Perlmutter (1978) and Burzio (1986).

It is important to ask whether unaccusative VPrt constructions are structurally similar to Group 2 constructions, or whether they in fact constitute a predicational sub-category of Group 1. An example of a Group 2 construction is shown in (21); the apparently similar unaccusative type is given in (22).

- (21) skrape {av} ruta {*av}
scrape {off} the windshield {off}
'scrape (the ice) off the windshield'

- (22) gå {på} bussen {*på}
go {on} the bus {on}
'enter the bus'

I will move forward based on the hypothesis that the latter type is predicational. In section 5.2.2, I will relate (22) to the traditional generative literature on unaccusatives and SCs. But in section 5.3, I will take a step further and discuss an alternative theoretical option, namely that (21), (22) and (18b) are structurally similar, i.e., inserted in a frame of the (17a) type. If so, their different interpretations must be explained with reference to the lexical-semantic and general-conceptual domains.

Dehé (2002: 33f) argues that intransitive verbs pose a problem for the SC analysis of VPrt constructions, since SCs would lack a subject. She illustrates with examples like (23). I have added the comparable Norwegian examples in (24).

- (23) a. The dogs played (*DP) around.
b. She grew (*DP) up in L.A.

- (24) a. Hundane snusa rundt.
the dogs sniffed around
'The dogs sniffed around'

- b. Ho voks opp på Byrkjelo.
 she grew up on Byrkjelo
 ‘She grew up in Byrkjelo’

These examples go right to the core of the problem that I will discuss below. I assume that they *can* be considered predicational if one assumes that the DP has moved from the subject position of the particle domain to fulfil the subject requirement in the matrix clause. Then they are identical to the standard Group 1 constructions except for the DP raising. (25) will be my starting hypothesis for the unaccusative VPrt constructions.¹⁶⁹

¹⁶⁹ The diagnostics for unaccusatives consist of both syntactic (Åfarli 1992) and semantic (Sveen 1996) criteria. Sveen (1996) claims that earlier attempts to define intransitive verbs fail syntactically (cf. also Borer 1998) because these approaches cannot deal with Norwegian impersonal active variants of unergative verbs, cf. Sveen (1996: 3) (i) and (ii) are rendered in *Bokmål*:

- (i) Det skrek et barn i naborommet (from Taraldsen 1978)
 it cried a child in the neighbouring room
 ‘A child cried in the neighbouring room’
 (ii) Det angriper en bjørn (from Åfarli 1992)
 it attacks a bear
 ‘A bear attacks’

A syntactic approach would predict the subject position of an unergative to be occupied and thus not available for an expletive. Therefore, Sveen follows Dowty (1991) in defining unaccusatives and unergatives semantically. Dowty (1991: 605ff) classifies the two sub-groups of intransitives using the criteria of telicity and agency; an agentive atelic verb is typically unergative, and a non-agentive telic verb is unaccusative. Sveen (1996: 66f) argues that the term “telic” should be replaced by the term “directed change”, since unaccusatives denote a change of location, state etc. (as in *Johan sovna* ‘John fell asleep’) and not necessarily telicity. Unergatives, on the other hand, have a locative or stative reading (*Johan sov* ‘John slept’).

However, the semantic distinction is not fully tenable; there is also a significant syntactic difference between the two groups. Unergatives cannot be used impersonally as freely as indicated above. Consider the classic unaccusative in (iii) and the unergative in (iiib, c). Only the former can be used easily in an impersonal construction, and the postverbal DP can be omitted.

- (iii) a. **Unaccusative:** Det gjekk (nokon) i gangen.
 it walked (someone) in the hall
 ‘There walked (someone) in the hall’
 b. **Unergative:** *Det tenkte (nokon) på planen
 it thought (someone) on the plan
 ‘Someone calculated the plan’
 c. **Unergative:** Det hosta *(?nokon) i gangen.
 it coughed (someone) in the hall
 ‘Someone coughed in the hall’

This is rather typical unaccusative vs. unergative behaviour. However, not all unergatives are equally bad in an impersonal frame. One can distinguish between unergatives which denote a “presentational” or observable action (*hoste* ‘cough’, *nyse* ‘sneeze’, *syngje* ‘sing’) and ones which do not (*angre* ‘regret’, *tenkje* ‘think’). It is my impression that the first of these two sub-groups can be used more naturally in an impersonal frame. Coughing, sneezing and singing can be heard, hence observed, but that is not necessarily the case regarding regretting and thinking. The difference between the main groups (unaccusatives and unergatives) is even clearer when the verbs combine with a particle. Consider the contrast between (iv) and (v)–(vi):

(25) DP V [_{sc} <DP> Prt]

5.2.2 *The Unaccusative Structure*

In this sub-section, I will relate my hypothesis to the generative tradition on unaccusatives. This implies the “low” insertion and subsequent raising of the relevant DP. In the particle context, the DP functions as the subject of the particle (as in standard Group 1 constructions) and raises to fulfil the subject requirement of the matrix.

A standard view of unaccusatives is that the subject DP is merged internally, then moves to the subject position to fulfil the subject requirement and create a proposition (if an expletive fails to be inserted). The following representation is taken from Hornstein et al. (2005: 107):

(26) Unaccusative verbs: [_{VP} V DP]

There are different syntactic tests that argue for such a representation; see, e.g., Burzio (1986) and Radford (2009: 249ff). Burzio (1986: 30) distinguishes “ergative” (= unaccusative) verbs from transitives and intransitives. For the unaccusatives, he suggests the underlying structure

-
- (iv) **Unaccusative:**
a. Johan gjekk inn.
John walked in
'John walked inside'
b. Det gjekk {inn} nokon {inn} (på toget)
it went {in} someone {in} (on the train)
'Someone entered the train'
- (v) **Unergative:**
a. Johan tenkte ut *(planen).
John thought out (the plan)
'John figured out the plan'
b. *Det tenkte {ut} nokon {ut} (planen).
it thought {out} someone {out} (the plan)
'Someone figured out the plan'
- (vi) **Unergative:**
a. Johan hosta bort *(lommeduken).
John coughed away (the handkerchief)
'John coughed so much that the handkerchief blew away'
b. *Det hosta {bort} nokon {bort} (lommeduken).
it coughed {away} someone {away} (the handkerchief)
'Someone coughed so much that the handkerchief blew away'

These examples suggest some crucial differences between the two groups. First, only the unaccusative behaves like a true intransitive in the a-versions. The two unergative verbs must take a DP in order to converge, and thus behave more like transitives.

in (26) and shows also that in Italian, the subject of an unaccusative can surface post-verbally (p. 26):

- (27) Affondarono due navi.
sank two ships
'Two ships sank'

A very interesting piece of syntactic evidence that can be taken as support for a “low subject” analysis comes from Henry (1995: 52), who reports on (a variant of) Belfast English. Unaccusative verbs in this dialect, unlike transitive verbs, can have a post-verbal subject spelled out in imperatives, cf. (28a):

- (28) a. Go you there.
b. *Read you that book.

Constructions like the one in (28a) give direct support for the basic representation in (26). The difference between Belfast English (*Go you there*) and Standard English (*You go there*) then becomes whether A-movement applies before or after spell-out. In such an analysis, we can stipulate that (28b) crashes because the VP has apparently two internal arguments.¹⁷⁰

Sveen (1996: 95ff) argues, despite some syntactic differences (e.g., with regard to passivisation and prenominal modifying possibilities), that the post-verbal DP (in bold type) is a *syntactic object*, both in the unaccusative *Det visna **mange blomster*** ‘There withered many flowers’ and in the unergative *Det skøyta **mange barn*** ‘There skated many children.’ There are also other works that support an object analysis of the DP, e.g., Askedal (1986), Vangsnes (1994), and Vikner (1995). Nordgård (2002: 68f) argues, in opposition to these works, that the post-verbal DP is a SC subject. I think Nordgård’s arguments for pursuing a subject analysis of the post-verbal DP in non-resultative expletive constructions can be questioned,¹⁷¹ but the crucial part for present purposes is what the DP itself combines with.

¹⁷⁰ In a full CP–TP–VP structure, (28b) might also serve as evidence that main verbs in English do not move to C:

- (i) [C Read [TP you [VP that book]]].

Assuming the imperative to move to T in (28a), we are forced to stipulate that the subject stays low there:

- (ii) [T Go [VP you there]].

¹⁷¹ Nordgård (2002: 68f) discusses stative examples like the following (in *Bokmål*):

- (i) Det sitter fugler på taket
it sits birds on the roof
'There are birds on the roof'

When it combines with a verb-particle, the predicational DP–Prt relationship promotes an understanding of the post-verbal DP as a subject. Thus, Nordgård’s (2002) SC analysis is definitely transferable to our approach. A SC analysis of the VPrt construction means that the SC is the structural object of the verb (or DynP), with the DP in the structural subject position of the SC.

With the post-verbal DP based in a subject position in VPrt cases, let us approach the unaccusative structure based on the analysis suggested by Radford (2009: 359ff). Radford assumes a split VP construction, in which the DP of an unaccusative enters into the subject position of the lower VP and raises to Spec,vP in Standard English. The verb movement to little v is motivated to give the structure a more agentive reading (Spec,vP being the position of agentive subjects). Radford’s representation of Henry’s example (28a) is given in (29).

(29)

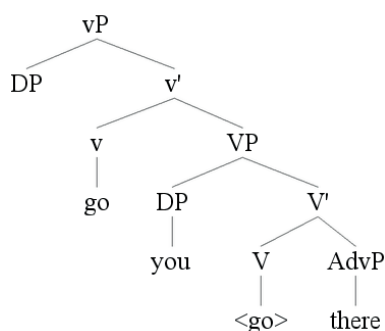

The difference between unaccusative and transitive constructions (cf. (26) above) is that the former has its subject merged with V', while the latter has its subject merged with little v'.¹⁷²

-
- (ii) Det står ein mann utanfor
it stands a man outside
'There is a man outside'

Nordgård argues for her view using evidence from adverb insertion and coordination, among others. She admits that the coordination test is not airtight, but I think the adverb test also fails. Stowell (1983) shows that causative SCs cannot be split by adverbs, and Nordgård claims this is the case for impersonal constructions, too:

- (iii) ??Det står ein mann av og til utanfor
it stands a man off and to outside
'There is a man sometimes outside'

However, the example is better with a short adverbial:

- (iv) Det står ein mann no utanfor
it stands a man now outside
'Now, there is a man outside'

The crash with *av og til* 'sometimes' might therefore be because the adverb is not in its canonical position. With a light adverb and a dislocated DP it converges more smoothly.

¹⁷² Since little v can be argued to be theory-internally motivated and lacks an interface interpretation (Kitahara 1997, Nygård 2013), one could follow Bowers (1993), who splits the VP semantically. He takes the property of

Henry (1995: 52f) shows that (29) is possible both with a standard VPrt construction (30a) and with a complex (30b) VPrt construction, but a non-predicational complement is not possible (30c). In Henry's terms, (29a, b) are telic, while (30c) is not. In our terms, (30a, b) are predicational VPrt constructions, while (30c) is not (at least if it is interpreted as a locative). The low subject in Belfast English unaccusatives can then be analysed by assuming raising from the SC to the matrix, but no (overt) movement to Spec,IP. (30a, b) are represented with the tree structure in (31).

- (30) a. Run you away.
 b. Walk you out of the door.
 c. *Run you in the garden.

(31)

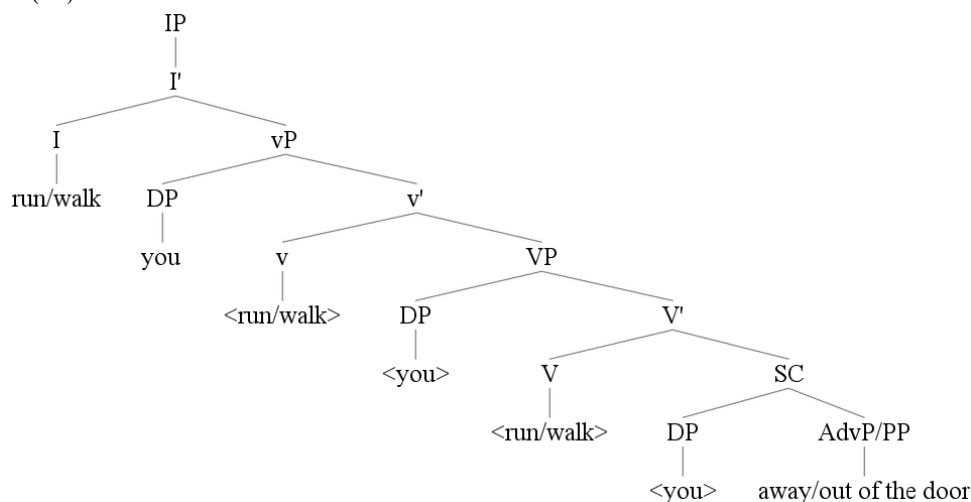

However, (31) cannot be a general representation for VPrt constructions since it cannot account for particle shift. In Norwegian, this problem can be solved following the approach I have taken so far, i.e., by assuming a structure with DynP above the SC. So, let us assume that the subject DP of an unaccusative is based in the particle SC before it raises to the matrix, and that the particle identifies Dyn in the regular manner. (32) shows a representation with DynP.

predication to motivate a functional layer, Pr(edication)P, in all subject–predicate constructions and thereby promotes a parallel analysis for verbal clauses and SCs. Then a subject will as a rule be based in Spec,PrP. I leave this issue open; Bowers' model could be represented in all the structures below, but I will not specify it explicitly.

- (32) a. Hundane sprang ut.
 'The dogs ran out'
 b.

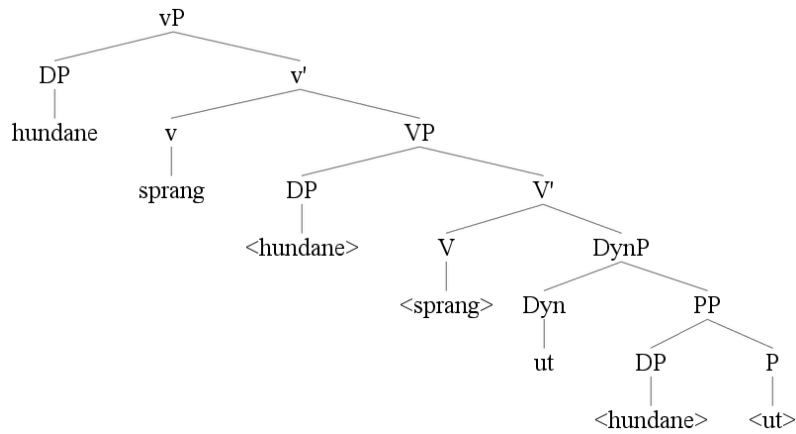

It may seem too complicated to insist on particle movement to Dyn, since the movement does not affect the word order. It does cross the base position of the subject DP, but the DP moves to the matrix. However, there are some indications that particle movement takes place. For instance, the main verb and the particle are spelled out with word accent in the relevant dialects, as was also the case for Group 2 constructions. And interestingly, an impersonal variant of (32) shows that the particle *can* alternate in some unaccusatives: See (33a), for which the proposed structure is given in (33b). Here, I assume that the expletive is directly inserted in the matrix Spec,vP (Áfarli & Eide 2000 suggest that the expletive is directly inserted in Spec,PrP). Since the subject position in the matrix clause is filled as a result of *det* insertion, the post-verbal DP stays in the particle domain. Apart from that, (32) and (33) are similar.

- (33) a. Det sprang {ut} nokre hundar {ut}.
 it ran {out} some dogs {out}
 'There ran {out} some dogs {out}'

b.

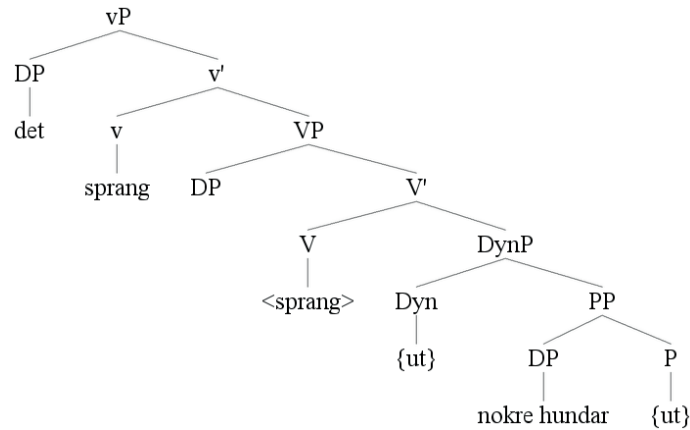

In (32)–(33), I have not specified the projections above vP, but I assume that the matrix subject and the finite verb are associated with TP (Nominative, tense) and CP (topicalisation, V2).

(33) is an interesting construction. The particle alternation shows that it is parallel to the Group 1 constructions, and that tendency is clear regarding additional impersonal unaccusative constructions as well. These constructions can also be extended by a resultative (or source) PP, as is the case with Group 1.

(34) a. Det sprang {ut} nokre hundar {ut} (til katten).

it ran {out} some dogs {out} (to the cat)'

'There ran out some dogs (to the cat)'

b. Det gjekk {på} ein mann {på} (på toget).

it walked {on} a man {on} (the train)

'A man entered the train'

c. Det kom {heim} ein gnom {heim} (frå storbyen).

it came {home} a gnome {home} (from the city)

'A gnome came home (from the city)'

Suppose that negation marks the edge of vP (cf. Adger 2003: 181, Áfarli & Eide 2003: 90f). Then, the insertion of the negation *ikkje* ‘not’ should demonstrate whether the particle-associated Figure DP in (33) is VP-external (if preceding Neg) or -internal (if following Neg):

- (35) a. **LPrt:** Det sprang {ikkje} ut {*ikkje} nokre hundar {*ikkje}.
 it ran {not} out {*not} some dogs {*not}
 ‘There didn’t run out any dogs’
- b. **RPrt:** Det sprang {ikkje} nokre hundar {*ikkje} ut.
 it ran {not} some dogs {*not} out
 ‘There didn’t run any dogs out’

From section 4.2 onwards, I have argued that the DP does not move in standard Group 1 constructions, and here it is clear that the DP cannot precede Neg in either of the examples in (35). In the LPrt construction (35a) it is also clear that the particle is stranded in Dyn and does not follow the verb across Neg. I have already used this fact several times as an argument against incorporation analyses (cf. the discussion on den Dikken 1995 in section 3.3 and Zeller 2001 in 3.5).

In this sub-section, I have tried to connect the VPrt analysis to the traditional analysis of unaccusatives, and to a well-founded analysis of predication. This approach entails several derivations and an assumption that personal and impersonal constructions are structurally related. In the next sub-section, I will question these relations and explore an alternative view, where the “frame hypothesis” is taken to the extreme. I will discuss the consequences of a model assuming direct insertion into frames, with as few movements as possible. Fewer properties will then be assumed to have a structural explanation, and more will be explained with reference to the S-semantic domain.¹⁷³

Notice that I will not use the double VP structure in the text that follows, other than in exceptional cases, since the motivation to do so in the preceding discussion was mainly to connect the unaccusative VPrt constructions to the mainstream literature on unaccusatives. For the discussion below, a simpler structure is sufficient.

¹⁷³ However, it is important to notice that the analyses in the present sub-section, with their respective derivations, are also fully compatible with a frame model. There is a possibility that the speaker has very few frame types available in a given mother language (Áfarli 2007 suggests five frames for the verbal domain for Norwegian), and that there are possible general movement operation possibilities within these frames.

5.3 Movement or Insertion in Frames?

In line with traditional derivational approaches, I have pursued a rather complex structure for the unaccusative VPrt constructions in the previous sub-section. But taking the discussion in sections 4.3 and 5.1 into account, I think it is appropriate to explore some more fundamental questions again. The key topics are derivation by particle movement and DP raising vs. generation by lexicalisation of separate frames. How do we “know” that there is particle movement and DP raising in the personal unaccusatives? Is there a possibility that the alternation in (33) is instead the result of the realisation of separate frames, and that the DP has a different status in the two frames? How should we then interpret the unaccusatives in relation to the standard Group 1 and 2 constructions (cf. the table in section 5.1.2)?

Now, with the possible particle alternation in the impersonal structure (33), there should be a strong indication that the DP in the personal variant in (32) is also in a predication relation with the particle, although the DP has its surface position in the matrix. Above, I argued that the DP has raised. Consider this pair, which is similar to (32)–(33):

- (36) a. Nokon gjekk på.
 someone went on
 ‘Someone entered’
- b. Det gjekk {på} nokon {på}.
 it went {on} someone {on}
 ‘There entered someone’

My point so far is that the possible particle alternation in the impersonal construction in (36b) can be taken as evidence for a standard predicational DP–Prt relation. Furthermore, this relation is probably also present in (36a), if one considers the two different variants to be derived from a common underlying structure (as would be the obvious analysis taking Burzio’s 1986 work into account).

However, these two variants need not be derived from a common source structure. If *på* ‘on’ has a DP complement, the particle movement in (36b) is impossible, cf. (37b):

- (37) a. Nokon gjekkk på toget.
 someone went on the train
 ‘Someone entered the train’
- b. Det gjekkk {*på} nokon {på} toget.
 it walked {on} someone {on} the train’
 ‘Someone entered the train’

Here the situation is similar to one discussed in section 5.1.1, cf. (38), which is repeated here:

- (38) skrape {*av} isen {av} ruta
 scrape {off} the ice {off} the windshield
 ‘scrape the ice off the windshield’

In section 5.1.1, I argued that a derivational model must stipulate the PP Integrity Hypothesis (PPIH) or a principle with the same effect in order to account for the impossibility of P movement: The second DP can apparently not be licensed by the trace of a P. Since a DP can be licensed by the trace of a verb, the PPIH would be an *ad hoc* stipulation. Exactly the same is the case with the impersonal unaccusative in (37b). A derivational model needs the PPIH or a similar device to explain the impossibility of P movement.

However, if we assume the alternative with the left-hand P to be the result of direct insertion of P in Dyn, the non-convergence is explained in the same way as in section 5.1.1: The P cannot license (provide Case to) two DPs. This favours an account based on a representational frame model. Notice that (37a) and the converging variant in (37b) also have “locative” readings (without V + P word accent spell-out), where the meaning is that someone was walking (inside the train) during the train trip.¹⁷⁴

If we consider (37a, b) to be the result of insertions into separate frames, one consequence is that only (37a) is a possible VPrt construction, because the P in (37b) cannot identify Dyn. In (37a), one can either assume a directional PP (with a different internal PP structure, cf. Svenonius 2003) or direct insertion of *på* in Dyn. Let us consider the latter alternative. (37a) is represented by (39a). Its locative counterpart is given in (39b); the pair is

¹⁷⁴ They are locative in the sense that they do not denote a “directed change”, but *på* ‘on’ does not express the physical location (unless the walking happens on the train roof); rather it expresses a “situational” state → “the train trip.” See Aa (2013) for arguments that the “physical-locative” reading ‘inside the train’ is an S-semantic interpretation. Although *på* does not denote place, I continue to call it locative, to promote the stative reading.

parallel to the Group 2 vs. transitive PP pair (*ta av bordet* ‘clear the table’) illustrated in section 5.1.1. Note that I have inserted the unaccusatives in frames that are identical to the *ta av bordet* structures in section 5.1.1.

(39) a.

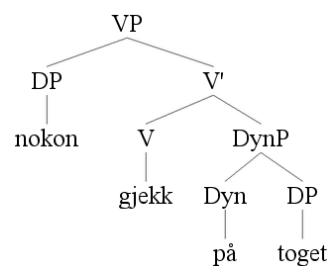

someone went on the train
 ‘Someone entered the train’

b.

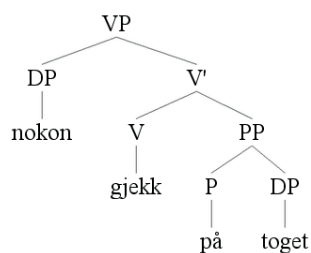

someone went on the train
 ‘Someone walked (inside the train) on the train trip’

Given (39), personal and impersonal constructions are not derived from the same origin, cf. (40).¹⁷⁵

¹⁷⁵ In (40), I have used the double VP structure again in order to house the expletive and postverbal DPs in their respective subject positions. However, as discussed in 5.2.2, there are several works that argue that the post-verbal DP should also be based post-verbally.

(40) a.

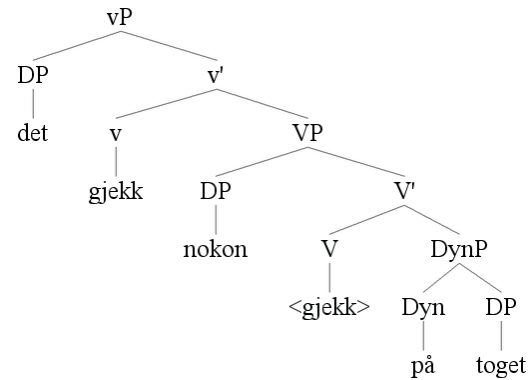

it went someone on the train
 ‘There entered someone on the train’

b.

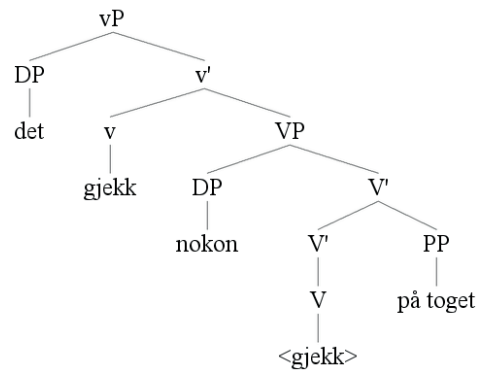

it went someone on the train
 ‘There walked someone (inside the train) on the train trip’

An analysis like the one suggested here, with direct insertion into separate frames and as few derivational steps as possible, naturally has several implications. (39a) and (40a) show that the personal and impersonal construction in (37) really turn out to be quite different, which suggests that personal and impersonal constructions are *not* structurally “related”, i.e., that they are not derived from a common basis.¹⁷⁶

¹⁷⁶ This is in line with the discussion in section 4.3.3, where I argued that apparently semantically similar examples like *Johan gav Margit blomar* ‘John gave Mary flowers’ and *Johan gav blomar til Margit* ‘John gave flowers to Mary’ must be structurally different.

I mentioned that the minimal meaning pair in (39) is structurally identical to a corresponding minimal meaning pair mentioned in section 5.1.1: *ta av bordet*, meaning “take everything off the table” or “steal from the table.” This could probably be considered a drawback and an oversimplification of the data, since Group 2 constructions and unaccusatives are quite different in other respects. Nevertheless, if one takes the full consequences of frame theory into account, the insertion of different combinations of lexical material into the same frame should be a natural thing to do.

In fact, if we assume that there are a few number of frames available, and when we strive to reduce the number of derivations, the ultimate consequence of frame theory would be to make *all* LPrt constructions fit into the pattern of (39a). Pursuing this possibility would mean that all of the following examples would be the outcome of insertion into that particular frame:

- (41)
- a. **Standard directional Group 1:** Kaste ut hunden.
‘throw out the dog’
 - b. **Standard metaphorical Group 1:** Rekne ut prisane
calculate out the prices
‘calculate the prices’
 - c. **Group 2:** Skrape av ruta
scrape off the windshield
‘scrape (the ice) off the windshield’
 - d. **Unaccusatives:** Gå på toget
go on the train
‘enter the train’

This is clearly a theoretical option. Assuming that all these examples manifest the frame in (39a) has several important implications for their relations to their respective related constructions. The relevant frame is repeated in (42):

(42)

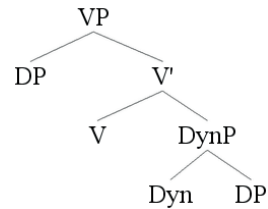

I mentioned the non-derivational relation between the personal (37a) and impersonal (37b), as suggested by (39a) and (40a), but (41) suggests an even more dramatic hypothesis, namely a non-derivational relation between LPrt and RPrt constructions in general. (42) is a non-predicational frame; if it represents all LPrt constructions, it means that also the directional (41a) is non-predicational. The insertion into Dyn promotes a strong V–Prt relation, and the DP is construed as a direct object. This essentially means that all LPrt constructions are “fixed” in some sense.

Let us assume that LPrt and RPrt constructions are not structurally related, and instead that all constructions with a left-hand particle, e.g., the examples in (41), are structurally identical. This will imply that structurally identical constructions are semantically quite different. That is, their *structural semantics* will be the same, given the common frame. Their differences must then be a consequence of the different lexical semantics and general S-semantics associated with the particular string (cf. the full interpretation model that I promoted in section 4.3.1).

Arguably, the RPrt construction *kaste hunden ut* ‘throw the dog out’ is more clearly directional than its LPrt counterpart in (41a). (41a) will in most cases have a directional reading too, but note that the more general interpretation ‘get rid of’ is also available. The combination *kaste ut* ‘throw out’ is very often used metaphorically,¹⁷⁷ and although the combination *kaste ut hunden* will naturally imply a ‘from inside to outside’ reading, this is not a necessary condition. Note that *kaste* in itself will most likely have a metaphorical reading (dogs are not literally thrown other than in cartoons), but the reason why the directional reading of (41a) is easily accepted can be argued to be S-semantic: We have a clear picture of dogs on a leash in the garden. That is a common concept about which we have general world

¹⁷⁷ The website <<http://www.nrk.no>> had the following headline on February 23, 2014:

(i) Østerrikes skipresident vurderer å kaste ut langrenn fra forbundet
Austria’s ski president considers to throw out cross country skiing from the federation
‘The Austrian ski president is considering to throw out cross country skiing from the federation’

In this complex LPrt construction, *kaste ut* ‘throw out’ is clearly metaphorical and means “to get rid of.”

knowledge. Similarly, *kaste ut mannen* ‘throw out the man’ can quite easily get the reading to get rid of the husband, i.e., to get divorced.

Consider the superficially similar but really quite different example *kaste ut Rosenborg* ‘throw out Rosenborg’, which has several readings if no further context is provided. If Rosenborg is taken to mean the football team (and not the area in Trondheim), there are at least two interpretations available, namely a directional and a metaphorical one. The team might be thrown out from a pub due to bad behaviour (directional reading) or thrown out of the league due to financial troubles (metaphorical reading). The first reading probably implies a metaphorical reading of *kaste* as well, since each member of the team will be forced to leave rather than be physically thrown out, but *ut* remains directional. In sum, simple *kaste ut* variants show that simple apparent directional LPrt constructions are in fact ambiguous, and that the structure and lexical items in many cases do not provide a “final” interpretation. Actually, S-semantic factors are of great importance.

What about (41b)? Here, the aspectual reading is definitely the more conventional one. *Rekne* ‘calculate’ and *prisane* ‘the prices’ are hardly imaginable in a directional concept. Calculation such that the prices literally ended up on the outside is a possible interpretation in a magical world, but not in the everyday world as we know it. The metaphorical option to calculate the prices ‘away’, i.e., to exclude them by calculating, is also a marginal interpretation, but probably less unlikely than the directional alternative. In sum, (41b) is clearly more unambiguously connected to one particular interpretation than (41a) is, but by manipulating the S-semantic factors, such as context and world knowledge, it becomes obvious that even the most “fixed” LPrt constructions are not completely stable as to interpretation.

Now, consider the Group 2 construction in (41c). Cast in terms of a traditional, derivational SC approach, this example will differ from Group 1 in that *ruta* ‘the windshield’ is not a Figure/Theme DP here. The Group 2 interpretation excludes *ruta* both as a structural and a conceptual subject. I stated in section 5.1 that a non-structural S-semantic subject (e.g., *isen* ‘the ice’) might be conceptualised, even though it is not part of the linguistic structure. However, note that (41c) also has a Group 1 interpretation that is at least marginally available, where *ruta* is the Figure DP: *skrape av ruta* ‘scrape so much that the windshield falls off.’ This marginal Group 1 interpretation forms a minimal meaning pair with the more conventional Group 2 interpretation. In a traditional derivational approach, this difference would be analysed as structurally based, but the hypothesis pursued here suggests that these two readings must be different interpretations of the same structure, corresponding to (39a),

and of the same identical lexical elements (*skrape + av + ruta*). Actually, whether *ruta* is conceptualised as Figure or Ground is a matter of world knowledge (S-semantics), rather than being linguistically determined. It is the specific situation or our world knowledge which determines which interpretation is the more appropriate.

Notice that the Group 1/Group 2 alternation is not possible in (41a). However, if *hunden* ‘the dog’ is replaced by *døra* ‘the door’, the same ambiguity as in (41c) is available; *døra* can be construed as a Figure *or* Ground DP. Either the door is thrown out (Group 1 interpretation) or something is thrown out (through) the door opening, i.e., a kind of a path interpretation (Group 2 interpretation). Thus, the lexical semantics of the DP facilitate the selection of a particular interpretation. When more than one interpretation is available (as in the case of *kaste ut døra* ‘throw out the door’), the knowledge of the specific situation decides whether it is a Group 1 or Group 2 construction, or rather, the constructions will be identical, so it would be more correct to call them Group 1 and Group 2 *interpretations* given this approach.

Finally, the unaccusative (41d) is also ambiguous. Given the VPrt analysis in (39a) (which excludes the “situational-locative” interpretation ‘walk (inside the train) during the train trip’), the most conventional interpretation will be to get on the train trip (i.e., to step inside the train before departure). But a locative (and not functional) reading of *på*’s ‘on’ complement is also possible, i.e., that *toget* means physically the train’s outside rather than referring to the to the trip. *Gå på toget* then means to collide with the train. This interpretation is even more plausible with the verbs *køyre* ‘drive’ and *sykle* ‘cycle.’ To get up on the roof of the train is a third possible reading of (41d). Again, this example shows the importance of general world knowledge. The structural and lexical semantics are not sufficient to provide a final and unambiguous interpretation.

In the derivational approaches to the analysis of VPrt phenomena, the relation between LPrt and RPrt constructions – known as the alternation problem – has been seen as one of the major challenges, if not *the* major challenge. Although the particle alternation can be analysed by assuming a simple and general head movement rule, I think the basic generative idea of LPrt and RPrt constructions being derivationally related – separated by one or more derivational steps – can be questioned. The frame approach makes it possible to postulate two frames, one for LPrt constructions and one for RPrt constructions. This entails that there is no explicit derivational relation between the two structures.

The consequence of adopting a full-blooded frame model is that some of the properties that are considered to be structurally based in the traditional derivational approaches are

relegated to the non-linguistic domain. When a Group 1 LPr_t construction and a Group 2 construction have identical structure (they are inserted in the same frame) and the lexical elements are identical, the difference must be general-conceptual. G-semantic explanations in the derivational model become S-semantic explanations in the representational model.

In the table in (43), I illustrate how the two models deal with all the possible interpretations of the string *ta av bordet* ‘take off the table’. The overview includes Group 1, Group 2, and ordinary PP interpretations; the right-hand particle is only possible with the Group 1 interpretation. In (44), I show the relevant differences in basic tree structures.

(43) The interpretations of *Ta av bordet* ‘take off the table’ in a derivational vs. a representational model

| <i>Ta av bordet</i> (**)av 'take {off} the table {off}' interpretations | Derivational model | Representational model |
|---|--|---|
| Group 1 (take the table off something, e.g., a cabin wall) | <ul style="list-style-type: none"> - RPrt and LPrt constructions separated by derivation (Prt movement to Dyn) - Predicational structure with the Theme/Figure DP analysed as SC subject (which is devalued in the LPrt construction) | <ul style="list-style-type: none"> - RPrt and LPrt construction represented with two separate frames. - DP as SC subject in the RPrt frame, and as complement of DynP in the LPrt frame |
| Group 2 (clear the table) | <ul style="list-style-type: none"> - Prt movement to or direct insertion in Dyn - RPrt structure impossible - Separated from Group 1 by lacking predication - Possible shadow interpreted (S-semantic) “Theme/Figure DP” (e.g., <i>maten</i> ‘the food’) | <ul style="list-style-type: none"> - Identical structure to the Group 1 LPrt frame - Separated from Group 1 S-semantically (world knowledge, interpretation) |
| PP (steal from the table) | <ul style="list-style-type: none"> - Non-predicational PP - Separated from Group 2 by lacking DynP - Directional or iterative S-semantic interpretation possibilities | <ul style="list-style-type: none"> - Non-predicational PP - Separated from Group 2 by lacking DynP - Directional or iterative S-semantic interpretation possibilities |

(44) a. **Group 1 derivational model**

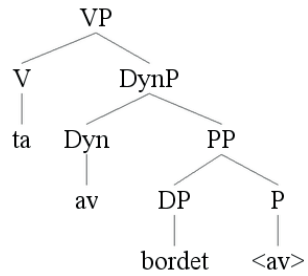

take {off} the table {off}
'lift the table off (something)'

b. **Group 2 derivational model (alternative 1)**

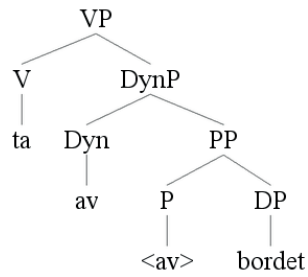

take off the table
'clear the table'

c. **Group 2 derivational model (alternative 2), Group 2 representational model, and Group 1 representational LPrt model**

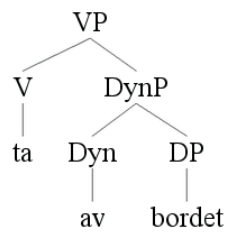

take off the table
'clear the table'

d. Group 1 representational RPrt model

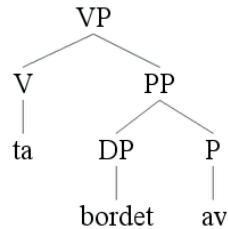

take the table off

‘lift the table off (something)’

e. Ordinary PP, derivational and representational model

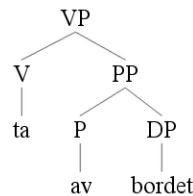

take off the table

‘take something (steal) from the table’

Concerning structures with extraction of the particle, they are only possible given the directional Group 1 reading, cf. the discussion on Taraldsen (1983) in 3.1 and 4.1.1.

- (45) Av tok han ikkje bordet.
 off took he not the table
 ‘He didn’t lift the table off (e.g., the wall)’

When the particle is extracted, the structure unambiguously gets the predicative reading with the table interpreted as the Figure. This is compatible with the analyses I have suggested, i.e., that the particle projects only in the RPrt case, but not when inserted directly into Dyn.

Given direct particle insertion in Dyn in all LPrt constructions, should we expect the DynP complex to be extractable? Extraction of LPrt + DP makes the Group 2 interpretation more accessible than the Group 1 interpretation:

- (46) a. Han tok ikkje av bordet.
 he took not off the table
Group 1 interpretation: ‘He didn’t lift off the table’
Group 2 interpretation: ‘He didn’t clear the table’
- b. **Group 1 extraction:**
 *Av bordet tok han ikkje.
 off the table took he not
 ‘He didn’t lift the table off’
- c. **Group 2 extraction:**
 Av bordet tok han ikkje ??(koppene).
 off the table took he not (the dishes)
 ‘He didn’t clear the table’

(46b) demonstrates clearly that extraction of the DynP complex is impossible in standard Group 1 constructions, as expected. Extraction of functional projections is not generally an option. For example, TP can not be topicalised:

- (47) * $[\text{Johan kunne fransk}]_i$ visste dei at t_i
 John could French knew they that
 ‘They knew that John could speak French’

Since DynP can be construed as a functional projection of a decomposed VP, it should be no surprise that it cannot A’-move. For the Group 2 interpretation, I argued in section 5.1.1 that the Figure DP does not have a covert G-semantic representation when is not overtly represented (it is only part of the S-semantics). But I argued that the particle still identifies Dyn. This makes the extraction in (46c) even more interesting. The prediction is that a topicalisation of PP is possible, but not of DynP. When the Figure DP (*koppene* ‘the dishes’) is included, extraction of the SC predicate is facilitated, as expected (because the structure is a “standard” SC without Dyn):

- (48) Han tok koppane av bordet → Av bordet tok han koppane.
he took the dishes off the table → off the table took he the dishes
'He cleared the table'

Note that *if* we accept the extraction in the short version of (46c) (without the parenthesis), then the suggested particle identification of Dyn is less likely. Then it is more likely that a conventional PP has been A'-moved. But the extraction of *av bordet* 'off the table' is arguably more felicitous *with* the parenthesis, which should suggest that the Group 2 interpretation of (46a) also includes a P identification of Dyn. Having said that, the short version of (46c) must be considered ambiguous as to whether the extraction is possible or not.

In sum, it is quite clear that the frame model is less complex in terms of syntactic derivations. It presupposes fewer derivations, and it predicts fewer direct relations between LPrt and RPrt constructions, and between personal and impersonal unaccusatives. When the difference between Group 1 and Group 2 constructions is taken to be an S-semantic matter (interpretation) rather than a G-semantic matter (structure), important aspects of the full interpretation of a sentence are moved out of the linguistic domain into the general conceptual domain. Some differences that are generalised as syntactic differences in the traditional generative approaches will be explained to a greater extent by semantic factors.

It is important to notice that when such a big part of the semantic explanation is resting on the S-semantic domain, then a satisfactory analysis of the linguistic expressions demands a much more elaborate analysis of conceptual structure than I am able to do in the present work. The goal here is rather to explore the borderline between the information that is provided by the linguistic vs. the general-conceptual domain. Thus, a careful and detailed empirical study is necessary, in order to form the basis of the rich conceptual structures. The Norwegian VPrt data show clearly that what has been considered purely G-semantic information in the traditional generative literature, should be reconsidered as S-semantic information. This is the consequence of a closer examination of the Norwegian empirical reality, the way I see it.

5.4 More on (Impersonal) Meteorological Constructions

In section 4.3.3, I used a couple of impersonal unaccusative meteorological examples to argue for direct particle insertion in Dyn, because a right-hand particle is impossible and a direct insertion is a more economical alternative if the frame is considered to be primary, cf. (49).

- (49) Det bles {opp} ein storm {*opp}.
it blew {up} a storm {up}
'A storm emerged/increased'

I will modify what I claimed in section 4.3.3 by suggesting that a right-hand particle is actually structurally possible in (49), but that the RPrt frame triggers a directional reading, which is incompatible with our knowledge of the world. The right-hand particle in (49) thus fails on S-semantic grounds, since a storm blowing in an upward direction is not possible (or at least very weird). *Det bles ein storm hit* 'there blew a storm here_{DIR}' is possible, on the other hand, since *hit* is an unambiguously directional lexical element. In a frame model, it is therefore possible to assume direct insertion into Dyn, as in (50a). In a derivational model with a predicational SC source, it would be necessary to account for obligatory particle movement, cf. (50b).

- (50) a. **Frame analysis:** Det bles [_{DynP} opp [_{DP} ein storm]].
b. **Derivational analysis:** Det bles [_{DynP} opp [_{PP} ein storm <opp>]].

Combinations of an unaccusative meteorological verb and *opp* 'up' or *på* 'on' are numerous (cf. Aa 2009a, b in *Norsk Ordbok*). The expressions in (51) all describe similar weather conditions; something starts or increases dramatically, e.g., the wind or the cloudiness.

- (51) a. blåsa / kula / skya / storma **opp** ...
blow / cool / cloud / storm **up** ...
b. auka / frisk(n)a / kula / kvika / skya / tjukna **på** ...
increase / freashen / cool / quicken / cloud / thicken **on** ...

All these examples can be used with a personal subject, or with *det* ‘it’, *der* ‘there’ or *han* ‘he’ as expletive subjects. The questions discussed above regarding derivations vs. direct insertions in frames are still relevant. Consider a personal variant of (50). Is *stormen* ‘the storm’ directly inserted in the matrix (52a), or is it a complement of Dyn before it raises (52b), or is it a subject for both the particle and the verb (52c)?

- (52) a. **Frame analysis:** Stormen bles [DynP opp].
 b. **Derivational analysis:** Stormen bles [DynP opp [DP <stormen>]].
 c. **Derivational analysis:** Stormen bles [DynP opp [PP <stormen> <opp>]].
 the storm blew up
 ’The storm emerged/increased’

I have already argued above that (52a) is the more economical alternative. If so, the personal and impersonal variants will not be derivationally “related” to each other, but will represent insertions into separate frames.

Furthermore, inserting the particle into Dyn rather than P better explains the non-directional reading of the structure. Interestingly, insertion of DegP *rett* ‘right’ forces a directional reading of the structure, so (53a) below sounds absurd. In contrast, (53b) is fine with a directional interpretation. In (53c), a directional reading is obligatory (though strange) when *rett* is inserted, while an inchoative reading is more appropriate without *rett*.

- (53) a. *Vinden auka rett på.
 ‘The wind increased right on’
 b. Vinden bles rett på
 ‘The wind blew right on’
 c. ?Stormen bles rett opp.
 ‘The storm blew right up’

The unacceptability of (53a) indicates that the particle is in the verb-adjacent position (Dyn), and that V and Dyn cannot be split by DegP, as in (54):

- (54) *Vinden auka rett på.
 ‘The wind increased right on’

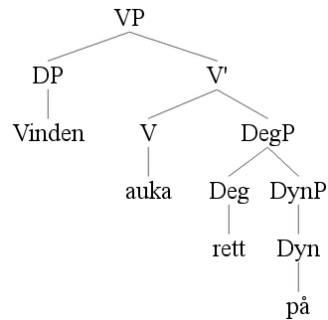

In a derivational analysis, the unacceptability of (53a) can be explained by the impossibility of the DegP complex to move as a complex unit from the P domain (see sections 3.3.5, 3.6.4, and 4.1.1).

I have already suggested that DynP is defective and lacks a specifier, which is compatible with such a hypothesis, but given that *rett* heads its own projection, it must further be the case that nothing can intervene between V and Dyn, which is natural given that DynP is a functional projection, cf. e.g., the non-intervention between V and a complement CP of V.

(53b) is fine, and I will assume it is a predicational RPrt structure. Note that without *rett* the sentence is ambiguous. *Vinden bles på* ‘the wind blew on’ has either a directional reading (where *rett* modification is possible) or an atelic reading (*rett* insertion is impossible). (53a) can only have the latter reading and therefore no *rett* insertion.

(53c) is less clear. Without *rett*, a non-directional, inchoative interpretation is plausible: ‘The storm started to blow.’ But as soon as *rett* is present, a directional interpretation is forced on it. In a normal world, a storm blowing in an upward direction is certainly weird as a continuous process, but single upward blasts from the storm are fully imaginable.

An impersonal variant of a meteorological construction is not only possible in the frame given in (50a). More frequently, the particle is intransitive, or it takes a PP complement, i.e., a resultative (55a) or an “agentive” *med* ‘with’ construction (55b, c).

- (55) a. Det bles opp (til storm).
 it blew up (to storm)
 ‘A storm blew up’

b. Han friskar på med vinden (Volda, West-Norw.)
he increases up with the wind
'The wind increases'

c. Det dvådde av med regnet (western part of Telemark, Ross 1895)
it stopped off with the rain
'The rain stopped'

(55a) is probably the most frequent of all meteorological VPrt construction types in Norwegian, and the two *med* 'with' constructions in (55b, c) are quite common, too (although *dvå* 'stop' is not a standard verb). All three examples can be paraphrased with the complement of the particle as subject of the main clause:

- (56) a. Stormen bles opp.
the storm blew up
'The stormed emerged/increased'
- b. Vinden friskar på.
the wind increases on
'The wind increases'
- c. Regnet dvådde av.
the rain stopped off
'The rain stopped'

The interesting thing to notice in (55) is that if we assume a derivational analysis and a predicational particle SC, the expletive must have moved from the SC, since the examples do not have a post-verbal DP as in (50). That would yield the following simplified representations of (55a, b):

- (57) a. Det bles [_{DynP} opp [_{SC} <det> <opp> til storm]].
it blew up to storm
'The storm blew up'

- b. Han friskar [_{DynP} på [_{SC} <han> <på> med vinden]].
 he increases on with the wind'
 'The wind increases'

In a frame model, these word strings will presumably be inserted in identical frames:

- (58) a. Det bles [_{DynP} opp [_{PP} til storm]].
 it blew up to storm
 'The storm blew up'

- b. Han friskar [_{DynP} på [_{PP} med vinden]].
 he increases on with the wind'
 'The wind increases'

But why is it that only (58a) gets a resultative reading? I suggest it is caused by the lexical semantics of *til* 'to' vs. *med* 'with'. *Til* expresses telicity, which is compatible with a general resultative reading. *Med* expresses juxtaposition (see chapter 6); the agentive reading of the *med* phrase can then be explained through its juxtaposition with the matrix subject (the expletive). As I will demonstrate below, juxtaposition brings together two agentive, Figure-like DPs.

As in the personal constructions in (53a, b), insertion of *rett* 'right' is impossible when a directional interpretation is impossible, cf. (59a). (59b) is quite naturally associated with directionality, thus *rett*-insertion is felicitous. But note that *det bles på* 'it blew on' is ambiguous, with the directional interpretation being one of two options. Practically the same is the case for (59c), but the non-modified variant *det bles opp* 'it blew up' strongly indicates an inchoative and not a directional reading, as was the case for (53c). With *rett*, the inchoative reading is excluded. Again, I ascribe this to the missing opportunity for modification of Dyn.

- (59) a. *Det auka rett på.
 'It increased right on
- b. Det bles rett på.
 'It blew right on'

c. Det bles rett opp.

'It blew right up(wards)'

Interestingly, an overt PP result does make the Deg insertion + inchoative reading marginally better, cf. (60a), which corresponds to (59c) + a PP result. However, a non-resultative construction, like in (50) above, cannot have Deg inserted, cf. (60b).

(60) a. ?Det bles rett opp til orkan.

'It blew right up to hurricane'

b. *Det bles rett opp ein storm.

'It blew right up a storm'

Intuitively, there is a conflict between the “fixed expression” *blåse opp* and the degree element *rett*. *Blåse opp*, as mentioned, refers to an inchoative event, or maybe also to an increasing intensity, and *rett* seems to be associated with direction or resultativeness. On the other hand, (60a) shows that these two apparently incompatible elements can probably be combined when complemented by a resultative Ground PP. Notice that their combination produces something like an “up on a scale” reading (as was the case with *skru lyden opp* ‘turn the volume up’ in section 4.3.4), so the inchoativeness of *blåse opp* “competes” with the resultativeness of *opp til orkan*. In sum, (60a) is a weird, but not impossible structure.

The particle must be “low” (i.e., resultative) in order for (56a) to converge, and the non-resultative (60b) is evidently impossible, probably because *rett* combines with a “high” particle. If the two structures in (60) are combined (except for the Deg insertion), the LPrt structure is now arguably better:

(61) Det bles {+opp} ein vind {-opp} til orkan.

it blew {up} a wind {up} to hurricane'

'There blew up a wind to hurricane level'

The paradox for the dispreferred (or certainly weird) RPrt construction here is that the insertion of the resultative PP matches it perfectly, while the right-hand particle position still dispreferred. I am not sure what the exact reason for that is, but I believe that it has to do with

the strong inchoativeness connected to the combination *blåse opp*. Note also that the PP result refers to a state or a level, not a physical location, and maybe that is “abstract” enough for LPrt to be preferred. Generally, I get the inchoative reading clearly with a LPrt, while the “up on a scale” reading is triggered by the more marginal RPrt distribution.

In sum, the meteorological constructions confirm what we have already seen with the “standard” unaccusatives in section 5.3, so the concluding remarks from there are still valid. In a representational model the syntactic operations are fewer, and more is explained in semantic terms. That is, different semantic factors become more important, and more differences are explained at the general-conceptual level. The meteorological examples specifically serve to corroborate DynP’s presence and properties. The *Norsk Ordbok* data and the introspective examples in the present sub-section show clearly that Dyn is associated with a metaphorical reading of the particle, and that V and Dyn are adjacent, in the sense that nothing can intervene between these head positions.

5.5 Conclusion

In this chapter, I have continued the discussion from chapter 4 (i.e., section 4.3) and included data that have not been discussed much before, in the model. I introduced examples of what I have referred to as Group 2 (62a) and unaccusative VPrt constructions (62b, c):

- (62)
- a. Nokon tok på bordet.
 someone took on the table
 ‘Someone laid the table’
 - b. Nokon gjekk på toget.
 someone went on the train
 ‘Someone entered the train (i.e., the train trip)’
 - c. Det gjekk {på} nokon {på}.
 it went {on} someone {on}
 ‘There entered someone (e.g., on the train)’

The personal variants here cannot have RPrt, because the associated DP is a Ground and not a Figure DP. Hence, its base position is “deeper” than the Figure DP in standard Group 1

constructions. I argued on the basis of different syntactic tests and semantic diagnostics that they are still VPrt constructions, and the impersonal variant in (62c) indeed shows that unaccusative constructions can have particle alternation. Taking a derivational model into account, the similarity between (62b, c) is only apparent. The unaccusative hypothesis (Perlmutter 1978, Burzio 1986) suggests that the matrix subject in (62b) raises from a post-verbal position, which in the particle context means the subject position of the particle domain. However, taking the discussion in 4.3 into account, I suggested that their difference is not necessarily structural. To the contrary, I developed a model in which metaphorical Group 1 constructions (see e.g. example (100b) from the conclusion of chapter 4), (62a), and (62b) are structurally identical, and differ on the semantic level instead. This means that the analysis must rely on third-factor principles, and that differences that are considered structural in a traditional generative model are considered general-conceptual instead. By moving the explanatory factors from the structure to different semantic processes, I in essence devalue the importance of the alternation problem, since LPrt and RPrt constructions are not derivationally related, but can be considered the result of instantiations of separate frames. I ended chapter 4 by asking the following questions: *What differences are structurally founded? What differences can be linked to the general-conceptual domain?* I have sketched a range of models, from those that are “completely” derivational to those that are “completely” representational, and some that combine elements of the two.

In section 5.3, I mentioned that I would not elaborate a detailed formalised analysis of conceptual structure in the present work, despite the fact that I ascribe much of the semantic information to be S-semantic. My goal has been to lay the empirical foundation for what must probably be considered an alternative view or approach in the generative VPrt tradition. Therefore, this work has a programmatic character, and a satisfactory explanation of our empirical findings demands a more detailed study of the third-factor principles.

6 *Med* ‘with’ as a Verb-Particle and Its Juxtaposition Semantics

In this chapter, I will present some complex verb-particle (VPrt) constructions and other predicational constructions initiated by the preposition *med* ‘with.’ *Med* is an interesting preposition because, unlike other prepositions, it is able to take a complex SC complement. This property is unique to *med* and its negation *utan* ‘without.’ There are quite a few works that have discussed this, e.g., Jespersen (1924, 1940), Beukema & Hoekstra (1984), Bech (1998), Aa (2004, 2006), and Anderson (2010). In addition to this, particle-*med* takes more complex complements than other particles, as we will see. In (1), taken from Aa (2004, 2006), I show examples in which *med* takes a SC complement, which is possible either without (1a) or with (1b) relativisation (in (1b), *R* denotes the relativised position). (2a, b, c) show a complex particle construction, with its three alternation possibilities. As shown in (2d, e, f) it is impossible for *ned* ‘down’ to precede *med*.

- (1) a. Mattis sat på land med [_{SC} tauenden i handa]
‘Mattis sat on the shoreside with the rope-end in his hand’
- b. Han fekk ei kake med [_{SC} lys på *R*]
he got a cake with candles on *R*
‘He got a cake with candles on it’
- (2) a. Ta med ned boka
b. Ta med boka ned
c. Ta boka med ned
d. *Ta ned med boka
e. *Ta ned boka med
f. *Ta boka ned med
take with down the book etc.
‘Bring the book down’

In this section, I will explain these (and more) data in terms of *med*’s basic semantic property of *juxtaposing* two elements.

In section 6.1, I present some of the earlier accounts discussing *med*'s property of taking SC complements. Jespersen (1924) was the first to my knowledge to note this, and I followed up his observations by analysing Norwegian data in Aa (2004, 2006). In section 6.2, I continue the earlier discussions by including particle data that have not been discussed before, namely those in (2). In sections 6.3–6.5, I will relate all these data and more to *med*'s basic semantics of juxtaposition, and I will suggest that the licensing of a SC is induced by the semantics of *med*. The SC is possible because *med* always selects a subject-like DP, which in some cases can select its own predicate. In section 6.6, I will analyse the particle data in a representational model, where also the juxtaposition semantics explains the variation in (2). The key idea is that *med* does not arrange a Figure–Ground constellation like other prepositions, but instead arranges a Figure–Figure constellation. In my analysis, that is basically the meaning of juxtaposition. Note that *med* to a greater degree than verbs can dictate syntactic structure. I will return to this major point towards the end of section 6.6. 6.7 concludes the chapter

6.1 Some Observations from the Literature Regarding *med*'s Ability to Select SCs

Otto Jespersen made an important distinction between *junction* and *nexus* in *The Philosophy of Grammar* (1924: 97ff). While *junction* is a notion pertaining to a DP with attributive elements (*a furiously barking dog*), a *nexus* is used as a common term for subject–predicate relations (*the dog barks furiously*), whether they are verbal or not:

A junction is (...) a single unit or single idea, expressed more or less accidentally by means of two elements. A nexus, on the contrary, always contains two ideas which must necessarily remain separate: the secondary term adds something new to what has already been named. (...) A junction is like a picture, a nexus like a process or a drama (Jespersen 1924 :116).

Having introduced the term *nexus*, he subsequently notes that

“[a] nexus may be the object of a preposition. In English this is particularly frequent after *with* as in: I sat at work in the schoolroom *with the window open* (different from: near the open window)” (p. 123f).

Crucially, Jespersen mentions that *med* often takes a similar complement in Danish. I have shown in previous work (Aa 2004, 2006) that this particular *med* construction is also quite frequent in Norwegian, and that it can take similar nexus/SC complements with relativisation:

- (3) a. Mattis sat på land med [_{SC} tauenden i handa]
 ‘Mattis sat on the shoreside with the rope-end in his hand’
- b. Han fekk ei kake med [_{SC} lys på R]
 he got a cake with candles on R
 ‘He got a cake with candles on it’

As shown in the English translation, a resumptive pronoun might occur in the predicate of the SC in (3b), which suggests a relative clause analysis in the Norwegian counterpart. Jespersen’s arguments for recognising the nexus are mainly semantic in nature. Beukema & Hoekstra (1984) analyse this absolute construction in the GB framework and argue syntactically – based on extraction restrictions – that it is sentential:

- (4) a. *What* did they hope for *e*?
 b. **What* did they hope for [*e* to happen]?
- (5) a. *Who* did you stay home with *e*?
 b. **Who* did you stay home with [*e* on television]?

In the a-versions, according to Beukema & Hoekstra, the empty category is Theta-marked and properly governed by the preposition. The b-versions are claimed to fail because there is a mismatch between what the preposition governs (the empty category) and what is Theta-marked (the whole portion in square brackets). Stowell’s SC hypothesis made it possible to generalise (4b) and (5b) as failing for the same reason, i.e., because of impossible subject extractions.

Jespersen (1924: 124, 1940: 41) also notes that *med* in constructions of the (6a) type has a very vague meaning; the SC can apparently neutralise the semantics of the preposition. I will return to this explanation below and argue that it is rather ‘incomplete’, and that the data are better explained by the juxtaposition hypothesis. (6) are Jespersen’s (1924) examples, and the relatives in (7a, b) are my own, taken from Aa (2006). (7a) was produced by a five-year-old; (7b) is taken from a Norwegian newspaper. I have added (7c), which was regularly produced by my daughter Astrid at age four.

- (6) a. with [_{SC} both of us absent]
 b. with [_{SC} all my prettiness and youth removed]
- (7) a. hatt med ikkje hol i
 hat with not hole in
 ‘a hat with no hole in it’
- b. kilt med ingenting under
 kilt with nothing under
 ‘a kilt with nothing inside it’
- c. bil med utan tak
 car with without [‘with-out’] roof
 ‘a car with no roof’

Bech (1998: 95ff) discusses some *med* constructions similar to the ones mentioned above. In the impersonal construction in (8), the SC predicate is overt and contains no relativisation. In *tough movement* constructions, like in (9), the predicate can be relativised, or in English, a resumptive pronoun can be inserted.

- (8) Det er fint med [lys på kaka]
 ‘It is nice with candles on the cake’
- (9) *Kaka* er fin med [lys på *R*]
 the cake is nice with candles on
 ‘The cake is nice with candles on it’

Bech proposes that *med* has the properties of a complementiser, since it takes sentential complements. I have previously claimed (Aa 2004, 2006) that Jespersen’s observations concerning the vague meaning of *med* are supported by (7). Therefore, there are apparently both good syntactic and semantic arguments for classifying *med* as a prepositional complementiser. In my earlier work, I claimed that *med* always has this vague semantics when introducing a SC. However, I am not really sure what is meant by *vague* other than ‘not (very) locative’, i.e., that it does not denote a spatial reference. In section 6.4, I will suggest

that *med* has clear semantic content in these constructions: the relevant SC constructions are a result of *med*'s property of juxtaposing two elements.

It is important to note that, among prepositions, taking a SC complement is a unique property of *med* 'with' (and *utan* 'without'). In (10), taken from Aa (2004, 2006), we see clearly that other transitive prepositions fail to do so in the relative variant. *På* 'on' and *av* 'of' can only select a simple complement.

- (10) a. ei samling **med** tusenvis av ulike plater (i)
a collection with thousands of different records (in)
'a collection with thousands of different records in it'
- b. ei samling **på** tusenvis av ulike plater (*i)
a collection **on** thousands of different records (in)
'a collection consisting of thousands of different records'
- c. ei samling **av** tusenvis av ulike plater (*i)
a collection **of** thousands of different records (in)
'a collection consisting of thousands of different records'

This list of prepositions can be extended to include *i* 'in', *mellom* 'between', *rundt* 'around', *for* 'for' and so on – all with comparable results. Only *med* and *utan* have the special property of taking a clausal complement. I will show that that is the case for *med* with VPrt constructions as well, at least that it can take a more complex complement than other particles.

6.2 "Double" VPrt Constructions – One or Two Particles?

I now return to VPrt constructions, which provide additional evidence for *med*'s unique property. In some cases, two particles seem to be included in the structure, but actually only one of them functions as a particle. For example, combining (11) and (12) yields the "double" construction in (13):

- (11) Ta med boka
take with the book
'Bring the book'
- (12) Ta ned boka
take down the book
'Bring the book down'
- (13) Ta med ned boka
take with down the book
'Bring the book down'

I will first discuss the data in a derivational model. In the present sub-section, I will discuss the internal SC structure, and continue with a discussion of *med*'s role in sections 6.3–6.5. Then, in section 6.6, I will try to explain the data in a representational model.

In a derivational model, the particle moves from a right-hand position of the DP in (11) and (12), and both Ps seem to have moved in (13) too, but that is actually impossible, given my model.¹⁷⁸ Only one of them can identify Dyn; in a movement analysis, the upper P blocks movement of the lower P, cf. Rizzi's (1990) Relativised Minimality.

Consider the structure in (14). The DP *boka* 'the book' is placed in the subject position of the lower PP, and it moves to the corresponding position of the higher PP. The movement can be motivated as a requirement to form a proposition with P_{med}.

- (14) a. Ta med boka ned
take with the book down
'Bring the book down'

¹⁷⁸ I also exclude the option of cliticising *ned* to *med*, so that *ned* would be dynamised together with *med* in (13) and (15a). The facts that *ned* is obligatorily prominent in all the possible structures in (15) and that it can split from *med* as in (15b) speak for different P projections.

b.

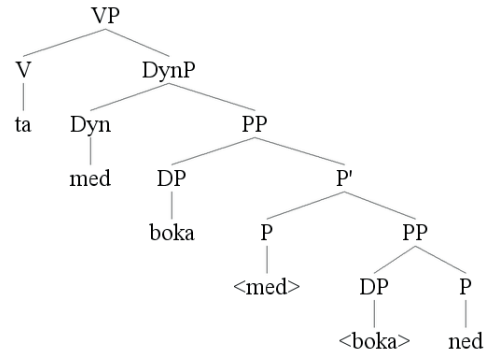

In a double SC structure, where *boka* raises from the lower to the upper SC to form two propositions, only one problem remains: when *ned* has nowhere to move (the closest head position is *med*'s base position), (13) remains a mystery. As shown in (2), repeated here as (15), three different word orders are possible; the only thing *ned* cannot do is precede *med*.

- (15)
- a. Ta med ned boka
 - b. Ta med boka ned
 - c. Ta boka med ned
 - d. *Ta ned med boka
 - e. *Ta ned boka med
 - f. *Ta boka ned med
- take with down the book etc.
'Bring the book down'

One could stipulate that *ta med* 'take with' is a lexicalised phrase, so *med* is actually V-internal and *ned* is dynamised in the regular particle manner. However, in V2 contexts, the verb also splits from *med*:

- (16)
- Han tok heldigvis med ned boka.
he took luckily with down the book
'Luckily, he brought down the book'

This suggests that both *med* and *ned* head their own phrases, and furthermore the three possible and three impossible word orders in (15) suggest that *med* must c-command *ned*. In

other words, the pattern in (15) follows directly from Rizzi's (1990) principle of relativised minimality. The closest head position to *ned* is *med*'s base position, hence *ned* cannot precede *med*. The assumption is that *med* can shift in the ordinary particle manner, but that any movement of *ned* is blocked.

Another indication that *med* is actually the particle is that only *med*, and not *ned*, is included in the typical word accent spell-out of verb + particle. In (15a), V + *med* is a prosodic unit: *ta-med*. *Ned*, on the other hand, is always prominent, and is never included in the prosodic unit with V and *med*. VPrt constructions provide a good example of the asymmetry between words and prosodic units; in addition to a left-hand particle, a light pronoun can be included in the prosodic unit in some dialects (*kasta-ut'n* 'threw out it'), but the fact that *ned* is obligatorily prominent seems to exclude it as a potential particle. Since *med* always precedes *ned*, and Dyn only hosts one position (if we exclude cliticisation), *med* is the only possible particle in (15).

But how should we then explain that both Ps can precede the DP, as in (15a), that they can surround it, as in (15b), and that they can both follow it, as in (15c)? The way I see it, based on what has been said so far, (14) is almost correct. In (15a), the DP in the focus position is usually prominent. This could indicate that it has shifted. Let us assume that (15a) is the result of *focus shift*, i.e. a rightward shift of the DP to an adjoined position, similar to heavy DP shift. A syntactic reason for this is suggested by the fact that we can find a PP (17a) or an AdvP (17b) in the complement position of *ned*, or alternatively adjoined to the right of the DP. Both these possibilities indicate that the DP in (15a) can be analysed as shifted.

- (17) a. Ta med ned {_{PP} til oss} boka {_{PP} til oss}
 take with down {_{PP} to us} the book {_{PP} to us}
 'Bring down the book to us'
- b. Ta med ned {_{AdvP} hit} boka {_{AdvP} hit}
 take with down {_{AdvP} here_{DIR}} the book {_{AdvP} here_{DIR}}
 'Bring down the book over here'

Since *med* blocks any movement of *ned*, the only possible movements are of the particle (*med*) to Dyn, (15a, b), and of the DP from Spec,PP_{ned} to Spec,PP_{med}. In (15c), *boka* precedes *med*, which can be accounted for by movement of the DP to Spec,PP_{med}, so that it creates a proposition with both prepositions. DP movement can be posited in (15b) for the same reason.

In (18a), the alternative positions/movements from (15b, c) are explicitly indicated.

Boka is base generated in Spec,PP_{ned} and can move, as in (15b). *Med* can identify Dyn, as in (15b), while *ned* is blocked in both constructions.

In (18b), the DP focus shift discussed above is taken into account to explain (15a).

(18) a. **Representation for (15b, c)**

Ta {med} boka {med} ned
 ‘take {with} the book {with} down
 ‘Bring the book down’

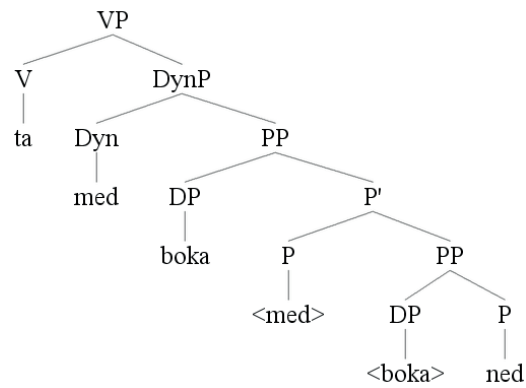

b. **Representation for (15a)**

Ta med ned boka
 take with down the book
 ‘Bring the book down’

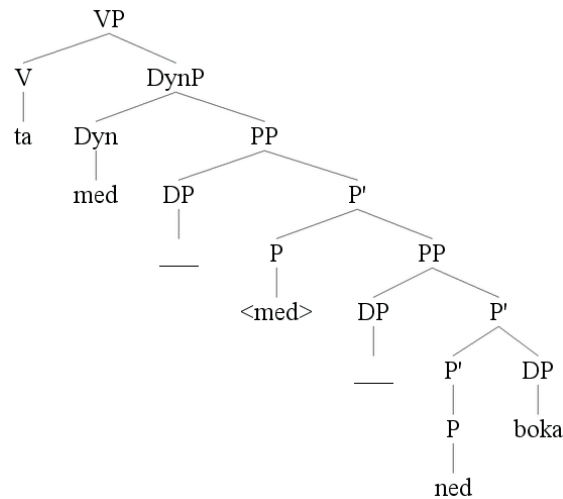

Note that it is impossible to have a second DP in the structure to form a proposition with the upper P (19a). To form a double predicational VPrt structure, the subject of the lower P domain must move to the upper domain. If *katten* ‘the cat’ is juxtaposed with *boka* ‘the book’, and not with *boka ned* ‘the book down’, the example converges (19b). However, (19a) cannot have particle movement, because that yields the ungrammatical (19c). This clearly indicates that the converging alternative in (19b) is a separate construction with one SC.

- (19) a. *Ta katten med boka ned.
 take the cat with the book down
 b. Ta [_{PP} katten med boka [_{PP} ned]].
 take the cat with the book down
 ‘Bring the cat along with the book’
 c. *Ta med katten boka ned.
 take with the cat the book down

This is a potential drawback of the predicational analysis, as I will discuss in section 6.6. There is apparently no good reason why a double predication analysis should presuppose DP movement but not allow a second Theme DP. However, a possible solution could be that the lower subject position is not independently licensed for an overt subject. Rather, in order to defend the analyses in (18), one must presuppose a common subject for the two SCs and stipulate that the subject cannot be spelled out in the lower position. Thus, my analysis depends on this particular rule.

6.3 *Med*’s Role in “Double” VPrt Constructions

Let us now take a closer look at *med*’s role in the “double” VPrt constructions, before I compare them with complex PPs. It is quite clear that the possibility of having a double VPrt construction depends on which particle is employed, or more precisely, whether the particle is *med* or not. In the examples below, I have used *med*, *på* ‘on’, *i* ‘in’, *rundt* ‘around’, and *ut* ‘out’ as particles, and in this way I have compared *med* with other Ps that have different semantic and syntactic properties. The pattern is clear: if *med* is chosen as the particle, the double construction is felicitous independently of which PP is chosen as its predicational

complement. If any other preposition is chosen as the particle, the construction crashes, again independently of which PP is chosen as its predicational complement.

- (20) a. Ta [_{Dyn} med] [_{PP} opp / ned / inn / ut / fram / rundt / over] boka.
 take with up / down / in / out / ahead / around / over the book
 'Bring ... the book'
- b. Ta [_{Dyn} på] [_{PP} *opp / *ned / *inn / *ut / *fram / *rundt / *over / *på / *til / *i] hatten.
 take on *up / *down / *in / *out / *ahead / *around / *over / *on / *to / *in the hat
 'Put on ... the hat'
- c. Få [_{Dyn} i] [_{PP} *opp / *ned / *inn / *ut / *fram / *rundt / *over / *på / *til / *i] veden.
 put in *up / *down / *in / *out / *ahead / *around / *over / *on / *to / *in the wood
 'Put in ... the wood'
- d. Dra [_{Dyn} rundt] [_{PP} *opp / *ned / *inn / *ut / *fram / *rundt / *over / *på / *til / *i] tråden.
 pull around *up / *down / *in / *out / *ahead / *around / *over / *on / *to / *in the string
 'Pull around ... the string'
- e. Kast [_{Dyn} ut] [_{PP} *opp / *ned / *inn / *ut / *fram / *rundt / *over / *på / *til / *i] hunden.¹⁷⁹
 throw out *up / *down / *in / *out / *ahead / *around / *over / *on / *to / *in the dog
 'Throw out ... the dog'

¹⁷⁹ This example is possible with *bak* 'back, behind' and *framme* 'at the front' as the lower preposition/adverb:

- (i) Kast ut {??bak / ??framme} hunden {bak / framme}.
 throw out {behind/in front of} the dog {behind/in front of}
 'Throw the dog out behind/in front of (something)'

Since the right-hand position (behind *hunden*) is the far better one, and since this is not possible with other prepositions/adverbs, I assume that *bak/framme* are adverbial adjuncts.

The answers suggested by (20) are similar to the answers suggested by (10): *med* allows a more complex complement than the other prepositions. It is worth noting that many of the non-converging alternatives in (20) are “conceptually” fully possible; it is not hard to imagine a dog being thrown out (and) down, cf. (20e), but grammatically *ut ned* ‘out down’ is completely impossible, and the same goes for e.g. *på ned* ‘on down’ and *i over* ‘in over’. The particle must be *med* in order for the complex construction to converge.

I claimed above that *ta med* ‘take with’ is not an idiomatic collocation. Consider the collocations in (21). *Med* can combine with other verbs and still take a structurally complex complement:

- (21) a. bringe med opp papira – bringe med papira opp – bringe papira med opp
bring with up the papers
‘bring the papers up here’
- b. lokke med ut unge – lokke med unge ut – lokke unge med ut¹⁸⁰
lure with out young
‘lure the young people to get out’
- c. bere med på sykkelen – bere med sykkelen på – bere sykkelen med på
carry with on the bike
‘carry the bike on (e.g., the bus)’
- d. frakte med heim bagasjen – frakte med bagasjen heim – frakte bagasjen med heim
transport with home the luggage
‘take the luggage home’

Again, it boils down to the properties of *med*. In the following two sub-sections, I will argue that the semantics of *med* is crucial if we are going to have any hope of gaining insights concerning the PPs and particle constructions discussed here.

¹⁸⁰ The third alternative corresponds to a headline in the newspaper *Sogn Avis*, January 29th 2013:

(i) *Lokkar unge med ut*
lures young with out
‘lures the young people to get out’

6.4 The Semantics of *med* – A Juxtaposing Preposition

Quite a lot has been said about *med*'s semantic and syntactic properties in Norwegian. Falk & Torp (1900: 329) discuss this preposition in a diachronic perspective, and for Modern Norwegian, its usage is detailed by Faarlund et al. (1997: 41ff) and Aa (2008). The latter work is the dictionary entry on *med* in *Norsk Ordbok*, which deals with spoken language and the *Nynorsk* written language, and it is based on primary source material consisting of more than 3000 “cards” (see section 1.4.3) with information and references on *med*, in addition to searches done in *Nynorskkorpuset* ‘The *Nynorsk* Corpus.’ Faarlund et al. (1997) and Aa (2008) present the preposition in similar ways: first, the locative use is discussed, then the temporal use, and finally everything that is not primarily connected to space and time – e.g., the use of *med* in instrumental, comitative, possessive, causative and partitive constructions, and more. In (22), I illustrate this with some examples from the dictionary.

- (22)
- a. **Locative:** Han vert ståande med døra
he becomes standing with the door
‘He remains standing close to the door’

 - b. **Temporal:** Eg kom bortåt Eidet med ølløv-tida (‘i elleve-tida’).
I came to Eidet with the eleven-time
‘I arrived in Eidet around eleven’

 - c. **Instrumental:** slå med ein hammar
‘hit with a hammer’

 - d. **Possessive:** Unge menn med sportsbil er dei farlegaste førarane
young men with sports car are the dangerous.SUPERLATIVE drivers
‘Young men in possession of a sports car are among the most dangerous drivers’

e. **Comitative:** Klaus var kollega med bestemor
Klaus was colleague with grandma
'Klaus was a colleague with grandma'

f. **Modal:** Han fekk i guds namn ta dem med makt
he got in God's name take them with power
'He had to take them with power, in God's name'

g. **Partitive:** Desse gardsnamna er med dei eldste i landet
these farm names are with the oldest in the country
'These farm names are among the oldest in the country'

This is a standard way of presenting the semantics of a preposition in a dictionary. The locative use is considered basic, the temporal use is derived from it, and the rest of the "meanings" follow and characterise the preposition in a wide sense.

All these classifications (or claimed meanings) are strictly speaking interpretations based on the surroundings of the preposition rather than the preposition itself. In Bouchard's (1995) terms, (22) is a simplified *situational semantic* (S-semantic) classification of *med*. In section 4.3.4, I discussed Bouchard's (1995) example of the French *dans* 'in' and Anderson's (2010) corresponding discussion of the Norwegian *i* 'in.' They both claim a container–containee relationship to be linguistically essential for the preposition; whether Ground is a locative or a more abstract reference is irrelevant. *Dans/i* 'in' places a Figure DP (at least partly) within the confines of a concrete or abstract Ground. Anderson (2010: 31ff) presents an overview over the basic semantic meanings of all spatial prepositions in the Vestnes dialect of Romsdal; the following hypothesis is formulated concerning *med* (translated from Norwegian by me):

- (23) The basic semantic content of the simple spatial prepositions is locative, and the basic semantic content of *med* is "juxtaposition" (Anderson 2010: 48).¹⁸¹

A standard example of juxtaposition would relate the subject of a sentence and the complement of *med*. In the examples in (22), the most transparent examples are the locative

¹⁸¹ "Det basale semantiske innhaldet til dei enkle spatiale preposisjonane er lokativt, og det basale semantiske innhaldet til *med* er "samanstelling"."

and the comitative, but all of the examples feature juxtaposition. For instance, in the partitive (22g), the specific farm names are juxtaposed with the oldest farm names in the country. The instrumental (22c) has a(n implicit) subject juxtaposed with the instrument (or in this particular case the action of hitting can be interpreted as being juxtaposed with the instrument). The modal *med* (22f) juxtaposes the verbal action of taking and the way the action is being carried out.

Anderson shows some examples of sentences where everything but the complement of the preposition is identical. Two of her examples are as follows:

- (24) a. Bestemor går med posten.
 grandma walks with the mail
 ‘Grandma delivers the mail’
- b. Bestemor går med rullatoren.
 grandma walks with the walker
 ‘Grandma uses a walker to get around’, *or*
 ‘Grandma brings the walker’, *or*
 ‘Grandma steals the walker’

The complement causes the interpretation of (24a) to be a (non-reciprocal) comitative and (24b) to be an instrumental. That is, the most conventional interpretation of (24b) is instrumental. The sentence could also mean that grandma brings the walker to someone else, or steals it. The two latter interpretations would make it a comitative of the (24a) type. Therefore, Anderson suggests that our interpretation is based on our knowledge of the specific situations rather than the semantics of the words themselves (cf. also Tyler & Evans 2003: 8). And regardless of the interpretation of (24b), *med*'s role is simply to juxtapose *bestemor* ‘grandma’ and *rullatoren* ‘the walker’. Anderson identifies juxtaposition as the lowest common denominator of all her examples ((24a, b) and three more not shown here). The specific interpretations and the lexical-semantic categorisation in (22) are in this respect not categorisations of *med*'s linguistic semantics, which are more simplistic and constant.

In Bouchard's (1995) terms, we can claim juxtaposition to be *med*'s *grammar semantics* (G-semantics). I have proposed in Aa (2013) that the G-semantic property predicts or “allows” the possible interpretations (the S-semantics) of a given preposition. The

classifications in (22) are based on context, pragmatics and world knowledge, but they are all captured by and structurally related through the G-semantic property of juxtaposition.¹⁸²

Anderson also adds another important point regarding *med*, namely that it covers the locative prepositions *ved* ‘at’, *hjá* ‘by, with’ and *hos* ‘by, with’ in many dialects, for example *ved* in (22a) and *hos/hjá* if the complement is represented with a person. This, she claims, contributes to a basic understanding of the preposition as given in (23). Concerning the last claim, it is worth noting that *með* in Old Norse had a wider locative use than in the modern *Bokmål* standard. Falk & Torp (1900: 329) show that the Old Norse *með* would be used where conservative *Bokmål* (*Riksmål*) prefer *langs(med)* ‘along’, *blant* ‘among’ and *hos* ‘by, with’. This places Anderson’s Vestnes dialect (and others) in a concrete historical perspective. The *Nynorsk* standard also allows a locative *med* instead of *ved* (cf. Hovdenak et al. 2006). Thus, the dialectal and historical orientation in *Nynorsk* (compared to *Bokmål*) is evident when it comes to the use of prepositions, too.

¹⁸² Notice that *med* ‘with’ apparently can have both *utan* ‘without’ (i) and *mot* ‘against, towards’ (ii) as its negation:

- (i) a. menn **med** sportsbil
men with sports car
‘men in possession of a sports car’
b. menn **utan** sportsbil
men without sports car
‘men not in possession of a sports car’
- (ii) a. gå/følgje **med** straumen
go/follow with the stream
‘go with the stream’, *or*
‘do like everyone else’
b. gå **mot** straumen
‘go towards the stream’, *or*
‘go against e.g. the opinion of someone’

My contention is that (ib), but not (iib), features a grammatical negation of *med* (cf. also Aa 2013: 156f). Claiming that *med* is a genuine juxtaposer amounts to claiming that it is always comitative in some sense. The English negation of *with* is thus quite transparent: *with* + *out* = minus *med* (cf. Rosenkvist 2004). Then *mot* cannot be a grammatical negation of *med*. *Mot* is derived from the noun *mot* = *møte* ‘meeting’, so that the meaning of the preposition is roughly ‘in meeting with’. *Med* is used in a directional construction in (iia), but is not directional itself. Rather, it juxtaposes a movement verb with a phenomenon which our world knowledge connects to movement (e.g., the flow of a river). Therefore, Norwegian dictionaries define the preposition as directional in similar examples. The preposition *mot* is generally defined as directional in constructions like (iib) as well. But again, it is because of the verb *gå* ‘go’ and the world knowledge of the phenomenon denoted by the complement. *Mot* only expresses a Figure’s orientation in the direction of – or in meeting with – the Ground (*mot* can be argued to be directional in the sense that it implies an orientation in the direction of a Ground (= Eng. *towards*) or orientated in the opposite direction of the Ground (= Eng. *against*)). But there does not even have to be movement involved (cf. *stå mot straumen* ‘stand against the stream’). *Med* and *mot* are thus not G-semantic antonyms, but in contexts involving movement, the specific situations can be interpreted as opposite.

6.5 The Licensing of a SC Complement

Let us continue to assume that the G-semantic property of *med* is juxtaposition of two elements. I will take this idea one step further by suggesting that *med*'s basic semantics is crucial for allowing a complex complement as well. The idea is quite simple. First, *med* always arranges a juxtaposition, which is the fundamental characteristic of the preposition. Then the interesting question is why the juxtaposed element (to the right of *med*) can have the form of a SC. What is the property of *med* and *utan* that allows a SC when no other preposition does? I will suggest that the licensing of the SC is an essential part of the juxtaposition semantics.

Consider the following examples. In the a-versions, *med* takes a simple complement, and in the b-versions it takes a SC complement (with relativisation in (25b)):

- (25) a. Mattis med tauenden
'Mattis with the rope end'
b. Mattis med [_{SC} tauenden i handa]
'Mattis with the rope end in his hand'
- (26) a. Kake med lys¹⁸³
'cake with candles'
b. Kake med [_{SC} lys på R]
cake with candles on
'cake with candles on it'

In the a-versions, a DP is juxtaposed with another DP, and in the b-versions, a DP is juxtaposed with a SC. These examples illustrate the essence of juxtaposition. My hypothesis is the following: A juxtaposition is the arrangement of two subject-like Figure DPs, and therefore the second DP can naturally be extended with its own predicate. In section 6.1, I

¹⁸³ I have argued (Aa 2004, 2006) that this example is structurally ambiguous as to whether it is a simple DP complement or the complement has an abstract SC predicate. My conclusions in the relevant works are not definitive, but extraction tests (see Aa 2006: 220) suggest that (26a) does *not* contain a SC, and I now believe that some of the nuances I claim to be structural in the earlier works do not have to be. For instance, the example from Faarlund (1974) *lektor med tøfler* 'teacher with slippers' can be structurally identical whether it has a locative or possessive interpretation. In previous work I suggested that this difference must be structurally founded, but I now think it is more likely that it is S-semantic.

showed that taking a SC complement is unique to *med* (and *utan*), cf. the following examples (repeated here).

- (27) a. ei samling **med** tusennis av ulike plater (i)
 a collection with thousands of different records (in)
 ‘a collection with thousands of different records in it’
- b. ei samling **på** tusennis av ulike plater (*i)
 a collection **on** thousands of different records (in)
 ‘a collection consisting of thousands of different records’
- c. ei samling **av** tusennis av ulike plater (*i)
 a collection **of** thousands of different records (in)
 ‘a collection consisting of thousands of different records’

The hypothesis is now that the Figure–Figure constellation in (27a) allows the SC (i.e., the predicate to the second DP), while (27b, c) entail standard Figure–Ground constellations and therefore cannot be extended with a predicate to the second DP. There, the second DP is already a predicate of the PP. Does this mean that the *med* complement is also a *structural* subject in (25a) and (26a), and in all other cases where it constitutes the complement alone? As shown in my previous work (Aa 2004: 103ff, 2006: 220), it does *not* behave syntactically like a subject in these constructions. In section 6.6, I will discuss similar data using a representational model, and I will argue that the DP complement must be understood conceptually as a Figure DP, but that there is no reason to assume that it must also be a structural subject.

First, let us return to the VPrt constructions in section 6.3, which can be construed similarly to (25b), (26b), and (27a). My hypothesis is that *med*'s inherent properties allow for a double predication structure which cannot be licensed by other particles. (28a, b) are simplified versions of (20a, b) above (and are specified with matrix subjects here):

- (28) a. Johan tok med ned boka
 John took with down the book
 ‘John brought down the book’

- b. Johan tok på (*ned) hatten
 John put on (down) the hat
 'John put hat on (with a downward movement)'

The convergence of (28a) can now be seen as a consequence of the semantics of *med*. First, *med* clearly has the role of juxtaposing the matrix with the lower particle SC. Second, and parallel to (25b), *med* licenses the subject–predicate constellation in the lower SC (*boka ned*):

- (29) Johan tok med ned boka – Johan tok med boka ned – Johan tok boka med ned
 John took with down the book etc.
 'John brought the book down'

Parallel to the data in (25)–(27), my hypothesis suggests that the double SC structure is possible due to *med*'s semantic properties. The DP *boka* 'the book' automatically gets a Figure reading and can select its own predicate. As shown above, the DP raises to fill the subject position of *med* as well, but that is not a result of *med*'s semantics. In the standard construction *Johan tek {med} boka {med}* 'John takes {with} the book {with}', *med* juxtaposes *Johan tek* with *boka*, independently of its surface position, and independently of whether one believes the particle to be a part of a predicational structure or not (cf. the discussion in section 4.3). What makes *med* special is that the DP associated with it is conceptualised as a Figure, and therefore sometimes can take its own predicate.

In the next sub-section, where I will discuss the "double" VPrt constructions in a representational model, we will return to what it means that the associated DP is conceptualised as a Figure. Specifically, it does *not* entail that the DP must be a structural subject. To the contrary, the lexical semantics of the concrete DP and our general world knowledge of it also play a role. This will demonstrate that some DPs (e.g., animates and smaller concrete objects) can get a more immediate and natural Figure interpretation than other DPs, which are more naturally conceptualised as Ground (e.g., DPs that denote bigger spaces and areas).

6.6 The “Double” Constructions in a Representational Model

In section 6.2, I mentioned a problem with the double predication analysis, where a DP raises from the subject position of the lower PP to the corresponding position of the higher PP:

- (30) Ta [PP boka med [PP <boka> ned]].
take the book with <the book> down
'Bring the book down'

In this analysis, the particle does not move, and *ta* 'take' takes a predicational PP complement. The predicational PP_{med} selects a predicational PP_{ned}, but they must share the subject; PP_{med} cannot have a separate subject from PP_{ned}:

- (31) *Ta [PP katten med [PP boka ned]].
*take the cat with the book down
'*Bring the cat the book down'

This calls into question whether a double predication structure can be rightly motivated or not, since the lower subject position cannot be properly licensed with an overt subject. Instead, the alternative is to stipulate an obligatory covert subject by rule. I repeat the converging and non-converging alternatives here:

- (32) a. Ta med ned boka
b. Ta med boka ned
c. Ta boka med ned
d. *Ta ned med boka
e. *Ta ned boka med
f. *Ta boka ned med
take with down the book etc.
'Bring the book down'

The differences between a derivational and a representational analysis of these examples are highly comparable with the differences outlined above in the table at the end of section 4.6.3. If we assume a direct particle insertion into separate frames, there are fewer possible

derivations, but the different structures are not directly related. Two of the converging examples, (32b, c), can be explained almost in the same terms as I used to explain the standard LPrt and RPrt constructions in a representational scheme in section 4.3 chapter 5.

Consider (32b), and assume direct insertion of *med* in Dyn. This construction is more complex than a standard LPrt construction since Dyn_{med} will still take a SC complement. I concluded that Dyn could select a DP in the standard LPrt variant: *kaste* [DynP *ut* [DP *hunden*]]. However, in section 4.3.3 I argued that Dyn could take a SC complement in other cases:

- (33) Det bles [DynP *opp* [SC *lauv (opp) på taket*]].
 ‘There blew up leaves (up) on the roof’

(32b) can be given a similar representation, cf. (34):

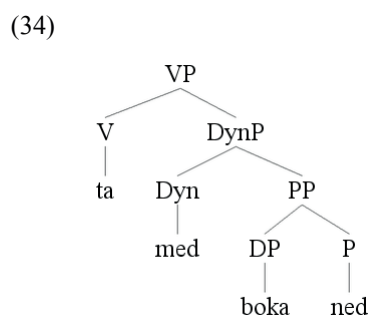

This is a more economical alternative than the derivational representation in (18a). The representation in (34) is also similar to the complex PP_{med} variants discussed in section 6.1, since *med* takes a SC complement. In some respects, (34) is reminiscent of a complex LPrt construction (cf. section 4.4), but *med* is the only particle that can take a predicational intransitive preposition, cf. (20) above. (34) does not really explain *med*'s structural property, since it only suggests what kind of SC it can select. As was the case in section 4.3 and chapter 5, the representational model thus implies that more must be explained at the general-conceptual level. Concretely in this case it means that the associated DP automatically gets a Figure reading when it is selected by *med*. This in turn implies that some DPs will be excluded in this position, such as if they have a lexical meaning which is incompatible with the Figure interpretation. I will illustrate this with some examples below.

What about (32c)? As mentioned, separate frames do not imply a direct connection between the alternative constructions in (32). But in (32c), a strict RPrT frame has an advantage over the derivational model in that it correctly excludes the possibility of a second DP in (31) by not providing any space for it. In (32c), V takes a complex SC complement, and *med* juxtaposes its subject with its complement. Notice that *med*'s role in this structure is simpler than in (18a). In the derivational model, one must presuppose a double SC structure. In this particular frame, *med* arranges only a straightforward juxtaposition. Thus, (35) is compatible with what should by now be expected from *med*; no other preposition can replace *med*'s position below (and select an intransitive preposition).

(35)

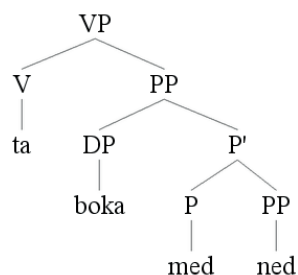

Why can there not be a frame where both *med* and *ned* have their separate subjects? As mentioned above, if a second DP is added to the structure in (35), it only converges if it is construed as the object of *med*, and not the subject of *ned*. In other words, it limits itself to which SC complex the main verb is able to select. The internal structure in the SC can and will of course vary, and it is dependent on which element heads the predicate. *Med* can take an intransitive preposition as complement, while *opp* ‘up’ and others must take a transitive P (cf. *ta boka opp/ned/ut/inn i *(hagen)* ‘take the book up/in/out/down in *(the garden).’ Since *ta* ‘take’ can only select one SC, there can only be one subject. This is a possible drawback of the representational model, because there is apparently no good reason why the internal SC structure should depend on the type of particle. However, there is reason to believe that *med* is special compared to other prepositions, and this can be a sort of lexical selection. Towards the end of the present sub-section, I will discuss why structural generalisations about prepositions are harder to make in a representational model than ones about verbs. That is, most prepositions can be generalised in identical Figure–Ground frames, but *med* and *utan* cannot.

Since these prepositions are unique, their particular behaviour must be ascribed to the lexical level.

The last and probably hardest nut to crack is (32a). I argued on the basis of syntactic and prosodic evidence in section 6.2 that the clause-final DP must be extraposed. But is extraposition an alternative in the representational model? Considering the arguments outlined above, I assume that it *is* in principle possible. In (36), two “competing” representations are shown, one in line with the discussion above, i.e., with extraposition (36a), and one straightforward representation with no empty positions (36b).

- (36) Ta med ned boka
 take with down the book
 ‘Bring the book down’

a.

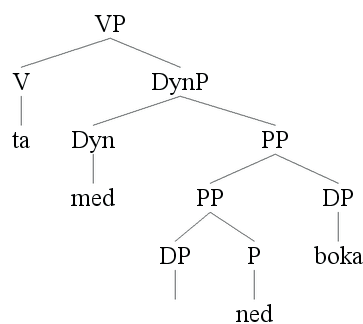

b.

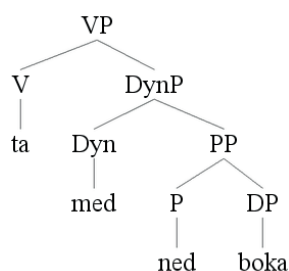

As discussed in section 6.2, I think there are good reasons to support the extraposition alternative, which also maintains the SC representation. However, let us consider the second alternative and see if it can be defended. (36b) is the more economical representation, but it does not account for the predicational relation between *boka* and *ned*. Arguably, *boka* must be construed as a “Theme” DP at some level, i.e., the G- or the S-semantic level. If *boka* is a G-

semantic object, as in (36b), it must be knowledge of the phenomenon ‘book’ which makes it less likely to be interpreted as a Ground, despite its syntactic position. Notice that a typical “Ground DP” (which denotes a space, passage or an area) is impossible in a similar structure. That is, a Ground interpretation is impossible.

- (37) a. Johan tok med ned [_{FIGURE} / *_{GROUND} trappa].
 John took with down the stairs
 ‘John brought down the stairs’
- b. Johan tok med ned [_{FIGURE} / *_{GROUND} fjellsida].
 John took with down the mountainside
 ‘John (triggered an avalanche which) brought down the mountainside (i.e., the snow, rocks, and trees etc. in the mountainside)’

(37a) is a possible sentence only if the stairs are interpreted as a Figure, e.g., if they are a toy or a tool that can be carried along. (37b) only converges if the mountainside is interpreted metaphorically as e.g. the trees and rocks (i.e. Figures) taken by an avalanche. (37) thus clearly demonstrates that the DP must have a Figure interpretation when in a relation with *med*. Usually, both a Figure and a Ground DP should be possible in a complement position (e.g., as the complement of Dyn), cf. Group 1 and 2 constructions:

- (38) a. Group 1: kaste [_{DynP} ut [_{FIGURE} hunden]]
 ‘throw out the dog’
- b. Group 2: ta [_{DynP} på [_{GROUND} bordet]]
 take on the table
 ‘lay the table’

In section 4.6.3, I suggested that this difference is S-semantic, and that (38a, b) could be analysed as being structurally identical. If a syntactic object can be construed both as Figure *and* Ground, it must be due to the lexical semantics of the DP and our world knowledge. *Ned* can take both a Figure and a Ground DP, and the content of the DP decides the relevant interpretation. Notice that only (39a) can have a corresponding RPrt alternative and will count

as a particle construction given a traditional derivational analysis. (39b) corresponds to Group 2.

- (39) a. Ta ned [_{FIGURE} boka]
 take down the book
 ‘Bring the book down’
 b. Ta ned [_{GROUND} fjellsida]
 take down the mountainside
 ‘Move (walk, climb, ski) down the mountainside’

However, if *ned* is replaced with *med* in (39), only the Figure interpretation is possible, as shown in (37). This suggests that *med* is essential for the interpretation of (37), and that juxtaposition basically means what I have claimed above, namely that two Figure DPs are juxtaposed. This is a crucial observation, because it also means that *med* should not arrange a Figure–Ground constellation in locative constructions, as opposed to, e.g., *i* ‘in’ and *på* ‘on’:

- (40) a. [_{FIGURE} Johan [_i [_{GROUND} sjøen]]]
 ‘John in the sea’
 b. [_{FIGURE} Johan [_{på} [_{GROUND} sjøen]]]
 ‘John on the sea’
 c. [_{FIGURE} Johan [_{med} [_{FIGURE} sjøen]]]
 John with the sea
 ‘John by the sea’

Only *med* does not select a Ground DP as complement; even when the DP itself is Ground-like it gets a Figure interpretation. I assume the Ground reading to be excluded by the definition of juxtaposition, which implies two Figure DPs.

The *med* construction below is ambiguous, with a comitative (41A) and a locative (41B) interpretation. Also, the locative interpretation suggests that the subject and the complement of *med* are juxtaposed; the subject is not in any respect part of or included by the complement of *med*. They are G-semantically similar, and most likely structurally identical. Since the lexical items are also identical, the difference must be S-semantically founded.

- (41) Johan sov med foreldra sine.
 John slept with parents REFL
 A: ‘John did the sleeping activity with his parents (in their bed)’
 B: ‘John spent the night in his parents’ house (they were not necessarily there)’¹⁸⁴

Again, *med* takes a subject-like (Figure) DP as complement independently of the particular S-semantic interpretation. I will continue to assume this to be characteristic juxtaposition. A DP in or within *med*’s complement is always construed as a Figure DP. This holds whether the DP constitutes the complement alone, whether it is the subject of a SC, or whether it is a complement within *med*’s complement. Selecting a DP that is either structurally or conceptually a Figure must be the essential property of *med*.

When this is taken into account, the most economical analysis (36b) becomes defensible, because the presence of *med* will override a Ground interpretation of the DP, even though it is in the complement position (of *med*’s complement). If (36b) is the correct structure, it suffices for the DP to be within the domain of *med*’s complement, in order to be given an interpretation as a Figure. This in turn overrides the *ned–boka* ‘down–the book’ constellation. However, (36a) is a more transparent representation in the sense that *boka* is the structural subject of *ned* (it is indeed the conceptual subject of *ned*), while the SC *boka ned* is juxtaposed with the matrix verb. I still do not think that extraposition should be excluded as a standard operation available in a representational model.

Now, if (36b) is to be adopted, *med* must always override the semantics given by the frame, which is a potential drawback. On the other hand, there is plenty of evidence that *med* is different from other prepositions, so (36b) should not be automatically excluded, despite the structural transparency of (36a). As shown in sections 4.3 and 5.1, a minimal representation generally devalues the G-semantics of the structure and leaves more of the semantic explanation to other domains. Whether the final analysis posits a more uniform derivational structure or separate structures with fewer (or no) derivations, it is inevitable to ascribe much of the above-mentioned variation to the lexical semantics of *med*. This means that although I take the structural semantics generally to be primary, *med* will play a crucial

¹⁸⁴ This locative interpretation is perhaps not that “available” in the *Bokmål* standard, where *hos* ‘by’ or *ved* ‘at’ would be preferred (cf. the discussion at the end of 6.4). However, this use of *med* is very common in many dialects, especially in North-West Norwegian (from Nordfjord to Romsdal), where some dialects hardly even have *ved* in their vocabulary (cf. Anderson 2010: 38). In Aa (2008), I present this particular use of *med* in *Nynorsk* and spoken Norwegian under the dictionary entry **med** III,A1a (see <<http://no2014.uio.no>>, accessed October 2014).

role. Now, is this a drawback for the idea of representational models and the significance of structural semantics? A central motivation for the exo-skeletal model is exactly the potential of a structure to override the semantics of the lexical elements. The lexical verb does not dictate the syntactic structure, but in many cases can have different syntactic realisations (cf. Borer 2005, Áfarli 2007, and section 1.2.2 above). But there is a crucial difference between verbs and prepositions. Compared to verbs, there are naturally significantly fewer prepositions that can be generalised in a given frame. Thousands of verbs can be inserted in a transitive frame (including spontaneously made verbs and verbs that are usually intransitive), while there is a finite number of prepositions that can be used at all in the standard transitive frame. It is surely possible to add an object to prepositions that are usually intransitive (e.g., to *opp*, *inn*, *ut* etc.), but it is not possible to make a preposition out of “any” word. They are not (or only very rarely) inflected,¹⁸⁵ and not as flexible and productive as verbs (cf. the discussion in section 1.2.2).

Consider the following examples, where I have tried to insert a preposition in the position of a verb in (42), and a verb in the position of a preposition in (43).

- (42) a. Johan *på* lyset.¹⁸⁶
 John on’ed the light
 ‘John turned the light on’

¹⁸⁵ However, the inflection sometimes is put on the particle in Swedish, so an inflected preposition is not fully unthinkable in all contexts. The following example was observed by linguist Marit Lulien at Lund University:

- (i) Namnet kom *på*s eftersom att bandet bor mycket *på* hotel.
 the name got on.PASS since that the band stays much on hotel
 ‘The name was suggested since the band stays much in hotels’

One can also hear Norwegian children say (ii) instead of (iii):

- (ii) Ho ‘*væmma*’ meg
 she be with.PRET me
 ‘She came with me’
 (iii) Ho var med meg
 she was with me
 ‘She came with me’

¹⁸⁶ I also got an authentic example of the (42) type from my 3-year-old daughter Ingjerd. The following dialogue took place when our new girl Johanne was three days old:

- (i) Me: La Johanne sove, ikkje borti ho no.
 let Johanne sleep, not touch.PREP her now
 ‘Let Johanne sleep, don’t touch her now’
 Ingjerd: Eg borta ho ikkje!
 I touch.PREP.PRET her not
 ‘I didn’t touch her!’

- b. Johan påa meg om nettene.
 John on'ed me at nights
 'John bothered me at nights'
- (43) a. *Johan slo lyset skru.
 John hit the light turn (where *skru* 'turn' replaces *på* 'on')
 'John turned the light on'
- b. *Johan plaga meg plage nettene.
 John bothered med bother nights (where *plage* 'bother' replaces *om* 'at')
 'John bothered me at nights'

(42a) is immediately understandable, although it is not standard in any variant of Norwegian. (42b) can be given a sensible interpretation given a certain context, say, if John is known for bothering people. *På* is associated with contact, and since *vere PÅ nokon* 'be ON someone' (bother someone, remind someone of something) is conventionalised, (42b) can quite easily receive a similar interpretation. But neither of the examples in (43) makes any sense. In (43a), I have replaced the particle with a conventional verb for turning the light on, and in (43b), I have used a random verb as preposition. No stretch of the imagination can make these possible. This has probably to do with the fact that prepositions are a closed word class, which cannot be productively expanded by other words. Prepositions exist in a finite number.

Since verbs are numerous and belong to an open and productive word class, while prepositions are not, it is also not possible to make generalisations about prepositions that are as robust as for verbs. Therefore, an exceptional situation for *med* is not unfortunate for the exo-skeletal model either. All other prepositions can be placed in the "standard" syntactic pattern for prepositions (as intransitives, transitives or particles), but since *med*'s properties are obviously unique, some syntactic patterns must be ascribed to the lexical semantics of this particular preposition.

6.7 Conclusion

In this chapter, I have discussed some complex constructions initiated by the preposition *med* 'with.' I showed using various different PP and particle data that *med* is special: it can take

more complex complements than other prepositions/particles. I explained this in terms of its semantics of juxtaposing two elements, where juxtaposition basically means the connection of two Figure DPs, not a Figure and a Ground, as is the case with conventional prepositions. This makes restrictions on what kind of DPs *med* can select (or at least on what kind of interpretation they can get). I also discussed whether the Figure–Figure constellation needs to be structurally represented, or whether it is conceptually given. The DP in or within its complement must be capable of having a Figure interpretation if the structure is going to converge. Even in cases where the DP has a “natural” Ground reading (such as *fjellsida* ‘the mountainside’), it is forced upon a metaphorical Figure reading when it combines with *med*, in order to converge.

- (44) Ta med [FIGURE / *GROUND fjellsida] ned.
take with the mountainside down
‘Take the mountainside (i.e., rocks and trees) down’

(44) clearly demonstrates that in the case of PPs, and especially in the case of *med*, the lexical semantics is crucial, and is also able to override the semantics triggered by the structural relations in the clause.

7 Conclusion

The main goal of this thesis has been to describe and analyse the verb-particle (VPrt) construction in spoken Norwegian. In standard directional constructions, the particle can appear to the left or the right of an associated DP; the particle alternation is shown in (1) (taken from Åfarli 1985: 75):

- (1) a. Jon sparka hunden ut.
'John kicked the dog out'
b. Jon sparka ut hunden.
'John kicked out the dog'

In section 1.1.1, I address the two following questions, which have been at the forefront of the discussion in the linguistic literature on VPrt constructions over the years: *What is the basic word order? How are the two word orders derived?* I argue against a commonly held assumption of the previous linguistic literature, namely that there is free particle alternation. Instead, I have followed the tracks of the dialectologically oriented literature, which states that spoken Norwegian prefers a left-hand particle (LPrt) with a dynamic interpretation. The opposite, a right-hand particle (RPrt), is used as a marked alternative, to emphasise a resultative interpretation. Thus, an important observation is that LPrt and RPrt constructions are semantically distinct.

My theoretical foundation is generative and can be placed within the Principles & Parameters tradition (cf. Chomsky 1981, 1993, 1995, and see sections 1.2–1.3). However, contrary to the standard Government & Binding and Minimalist theories, I defend an exoskeletal grammar model and reject the common assumption that the lexical verb is the basic building block of the structure-building component. Instead, I argue that the structure is generated independently from the lexicon (cf. Borer 2005, Åfarli 2007, Lohndal 2014). Furthermore, the structure is the primary carrier of meaning; the structural semantics (2i) is modified by the semantics of the lexical elements (2ii), and by general world knowledge (2iii). These three factors lay the foundation for the full interpretation of the structure.

- (2) The full interpretation of a structure depends on the three following factors in the given ranked order:
- i. The semantics of the structure
 - ii. The semantics of the lexical elements
 - iii. The general non-linguistic situational semantics (e.g., world knowledge)

In my analysis of Norwegian VPrt constructions, I aim to explore the interplay between these three levels. I discuss cases where there is “harmony” between them, and cases where there is more “friction”.

The factors in (2) are related to the domains in (3), concerning structural variation. I have discussed two separate principled ways of analysing structural variation:

- (3) **Structural variation** is regulated
- a. on the phrase structure level, and
 - b. by different operations applying to the same phrase structure.

In chapter 4, one of my main concerns regards whether the particle alternation in (1) is the outcome of operations/derivations (e.g., particle movement), cf. (3b), or whether (1a) and (1b) in fact manifest different syntactico-semantic frames (cf. Åfarli 2007), cf. (3a).

I have basically taken my data from the *Nordic Dialect Corpus* (Johannessen et al. 2009) (see sections 1.4.3.2 and 2.1.2), but also from other dialectological sources, e.g., *Norsk Ordbok* (see 1.4.4) and earlier empirical accounts, such as Aasen (1848, 1864) and Sandøy (1976). In 1.4, I discuss the different methods (including introspection and acceptability judgement tests) and tools that are important for the project.

In chapter 2, I map the central empirical phenomena to be analysed. Here, the LPrt preference is confirmed, and the semantic distinction between LPrt and RPrt constructions is examined. The most basic data that I introduce are standard directional (4) (which corresponds to (1)) and metaphorical (5) constructions, and complex constructions (6) (the latter with a resultative PP) (I will comment on additional data further below).

- (4) Johan kasta ut hunden.
‘John threw out the dog’

- (5) Johan las ut boka.
 John read out the book
 ‘John finished the book’
- (6) Johan kasta ut hunden i gangen.
 John threw out the dog in the hall
 ‘John threw the dog out in the hall’

In chapter 3, I discuss previous theoretical accounts that in one way or another include Norwegian VPrt constructions in their discussions. These accounts include Taraldsen (1983), Åfarli (1985), den Dikken (1995), Svenonius (1996a), Zeller (2001), Ramchand & Svenonius (2002), and Ramchand (2008). Generally, I place myself in the tradition that analyses the VPrt construction as a small clause (SC). Therefore, I concentrate mainly on earlier predicational and resultative analyses (nevertheless, I question and challenge fundamental parts of my self-placement in the SC tradition from section 4.3 onwards). I use the data from chapter 2 actively when evaluating the earlier theoretical accounts, and I conclude that neither of them explains the Norwegian particle alternation satisfactorily.

In chapter 4, I defend a DP–Prt base order in VPrt constructions; I have by then already argued in section 3.1 that Taraldsen’s (1983) model meets several empirical and conceptual problems due to his assumption of the opposite base order. By taking directional (4) vs. metaphorical (5) constructions into account, I argue that the particle alternation is explained by a semantically motivated leftward particle movement, where the particle identifies the structural-semantic node *Dyn* (for *dynamic*). (7) gives a simplified representation of (4) and (5).

(7)

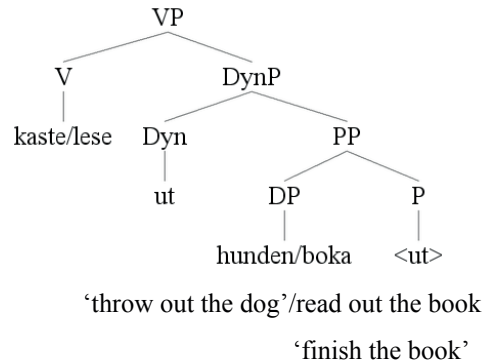

The result of the particle movement in (7) is a weakening of the predication relation between the DP and the particle. Here, Taraldsen’s (1983) model is important, since he assumes only the RPrt construction to be predicational (with a leftward DP movement into the SC subject position). While Taraldsen sees clear differences between predicational (RPrt) and non-predicational (LPrt) structures, I argue that the difference is more marginal. DynP is a verb-adjacent (but verb-separate) projection, and the structure is dynamised when Dyn is identified.

In section 1.1, I formulate ten research questions (RQs), and the discussion so far in this concluding chapter relates to RQs 1–3.

RQ 1: Is it the case that LPrt and RPrt constructions are semantically distinct and that LPrt constructions are generally preferred in Norwegian, and what do the semantic and grammatical differences consist in more precisely?

RQ 2: What is the nature of the syntactic structure and derivation regarding Norwegian VPrt constructions?

RQ 3: How can the interplay between structural, lexical and non-linguistic meaning best be integrated in an analysis of Norwegian VPrt constructions?

Concerning RQ 1, I have found that LPrt constructions are generally preferred in Norwegian, and that there is a semantic distinction, which relates to (2i), namely the lexical identification of Dyn, cf. (7). This means that there is a structural-semantic distinction between LPrt and RPrt constructions, as to whether Dyn is “activated” or not. In a traditional derivational model

(discussed in sections 4.1–4.2), Dyn is most likely identified by particle movement from a DP–Prt base order. The evaluation of Taraldsen (1983) (section 3.1) and den Dikken (1995) (section 3.3) shows that a Prt–DP base order leads to several empirical problems. This sketch also constitutes my brief answer to RQ 2. However, RQ 3 opens up for new perspectives on RQ 2, when the interplay between (2i), (2ii), (2iii) is discussed. This is done mainly in section 4.3 onwards, and my answer to RQ 3 is that (2i) is the basic semantic determinant, which (2ii) and (2iii) in turn modify and enrich. In the exoskeletal model that I pursue, the lexical and non-linguistic modification of the structural semantics actually turn out to be quite crucial.

Section 4.3 is a crucial part of the thesis. Here, I discuss the derivation of VPrt constructions in more detail. Eventually, I favour a representational model over a derivational model, and here the factors depicted in (2) (and thus RQ 3) are essential. At this point, I also suggest, based on extraction tests, that (4) and (5) may be structurally separate, i.e., that only the former is predicational and entails particle movement, as in (7). This relates to RQ 4:

RQ 4: How should the syntactic and semantic differences between directional and metaphorical structures be modelled in an analysis of Norwegian VPrt constructions?

The suggestion is now that the metaphorical construction is non-predicational – with direct particle insertion in Dyn. I suggest that this operation is a structural counterpart of idiom formation in terms of Bruening (2010).

(8) Metaphorical structure

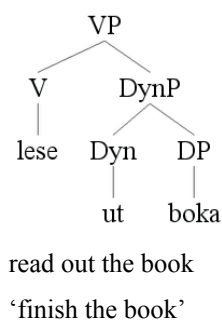

In section 4.4, I discuss VPrt constructions with an additional resultative PP, where RPrt is generally preferred (cf. Sandøy 1976: 105). (9) leads to RQ 5.

- (9) Han bar {?ut} fangst'n sin {+ut} åt dei fattige.
 he carried {out} the catch REFL {out} to the poor
 'He carried his catch out to the poor'

RQ 5: Why is the RPrt pattern generally preferred when there is an additional resultative PP complement to the VPrt?

The answer that I suggest here is that the resultative PP complement manifests the RPrt scheme and contradicts the Dyn semantics. It does not make LPrt impossible, but there is generally more friction between Dyn and the resultative PP.

Apart from the above-mentioned issues, the most important empirical contributions in this thesis are given in chapters 5–6. In chapter 5 (section 5.1), I discuss the so-called *Group 2* constructions (cf. Ven 1999) (as opposed to the standard constructions in (4)–(5), which are named *Group 1* by Ven). In Group 2, the associated DP has a Ground interpretation (unlike the Figure interpretation in Group 1) (cf. Talmy's 1972, 1985, 2000 notions of *Figure* and *Ground*). (10) leads to RQ 6.

- (10) dekke på bordet
 cover on the table
 'lay the table'

RQ 6: How should the so-called Group 2 VPrt constructions be analysed in order to account for their basic syntactic and semantic differences as compared to Group 1 VPrt constructions?

I argue that the Group 2 constructions should be analysed as non-predicational. This in turn demonstrates the interaction between (2i) and (2iii), because what is actually laid on the table in (10) (e.g., plates) is not structurally (2i) given.

Note that if (10) is non-predicational and we argue that it is structurally identical to (8), cf. (2i), then we must assume that the relevant differences between (8) and (10) concern the levels (2ii) and (2iii), i.e., the lexical and general-conceptual levels. These are essential questions in the thesis: Are Group 1 and 2 constructions different on the structural level (2i), or is their difference lexical (2ii) and of a non-structural, semantic character (2iii)? A strictly representational model suggests that some of the differences that are assumed to be structural

in a traditional derivational model are relegated to the general-conceptual domain. G-semantic issues become S-semantic issues; (2iii) becomes more relevant.

In chapter 5 (section 5.2), I also discuss unaccusative (cf. Perlmutter 1978, Burzio 1986) VPrt constructions. (11)–(12) relate to RQ 7.

- (11) a. Nokon gjekk på (toget).
 someone went on (the train)
 'Someone entered the train'
 b. Det gjekk {på} nokon {på}.
 it went {on} someone {on}
 'There entered someone'

- (12) a. blåse opp
 blow up
 'start blowing'
 b. auke på
 increase on
 'increase'

RQ 7: What are the basic structural properties of unaccusative VPrt constructions, and can their basic properties be assimilated to the properties of either Group 1 or Group 2 VPrt constructions?

(11a) is similar to Group 2 because the DP *toget* 'the train' has Ground interpretation, but (11b) is similar to Group 1 because of the alternation possibility (which is impossible in Group 2). But note that (11a) and (12) are derivationally similar to Group 1, with the difference that the matrix subject has raised from the SC subject position in the unaccusative variants. I analyse (11)–(12) both in a traditional derivational model (with DP raising in (11a) and (12)), and in a strictly representational model. I finally argue that they can be shown to be similar to the data in the discussion in sections 4.3 and 5.1. Again, when (11a) is analysed in the same syntactico-semantic frame as (4), (5), and (10), i.e., they are identical concerning (2i), it forces us to explain their differences on the general-conceptual (S-semantic) level (2iii). The most basic (and non-predicational) LPrt frame possible for representing (4), (5),

(10), and (11a), is given in (13). In chapter 5, I discuss the consequence of adopting such a basic model as opposed to a more traditional derivational model.

(13) **The most basic possible LPrt frame**

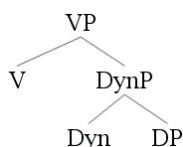

In chapter 6, I discuss the complex *med* ‘with’ constructions given in (14), and I see their complexity in connection with *med*’s basic semantics of juxtaposing two elements, cf. RQ 8.

- (14) a. Ta med ned katten.
 b. Ta med katten ned.
 c. Ta katten med ned.
 take with down the cat etc.
 ‘Bring the cat down’

RQ 8: Why does *med* ‘with’ used as a VPrt license a more complex structure than do the other VPrts, and what are the syntactic and semantic properties of VPrt constructions involving *med* ‘with’?

These constructions connect to some classic work of Otto Jespersen (1924, 1940) and also some of my own earlier works on *med* (Aa 2004, 2006, 2008). My goal in this chapter is to demonstrate the syntactic power of the basic semantics of this particular preposition, and thus show that the lexical semantics (2ii) (of prepositions) in some cases is syntactically crucial. When I argue that *med* ‘with’ juxtaposes two elements, it means that *med* brings about a semantic Figure–Figure constellation instead of the conventional Figure–Ground constellation arranged by other prepositions.

In sections 4.5–4.6, I discuss VPrt constructions in the Mainland Scandinavian (MSc) languages, and mainly concentrated on Swedish in the former of the two sections, and on written Norwegian as a mixture of spoken Norwegian and written Danish, in the latter section. This leads to the two following, and final, RQs.

RQ 9: Why and to what extent are Swedish VPrt constructions structurally different from Norwegian ones, and how could the differences be analysed structurally?

RQ 10: Is it possible that the contemporary Norwegian VPrt patterns can be the historical outcome of the influence of the Danish VPrt pattern on a traditional domestic Norwegian pattern?

Concerning RQ 9, I try to adapt Swedish into the analysis of Norwegian developed in section 4.3; thus, I launch three alternative answers, and favour the latter: 1) Swedish directional and metaphorical constructions are parallel to the Norwegian counterpart outlined in section 4.3.6 (particle movement to Dyn vs. direct insertion), 2) Swedish features a right-hand DP shift, or 3) neither directional nor metaphorical constructions are predicational in Swedish, but they differ with regard to the semantic content of the node identified by the particle. Alternative 3 suggests that Swedish metaphorical constructions have identical structural semantics to the Norwegian counterpart in (8), while directional constructions employ a resultative phrase (resP), as in Ramchand (2008), cf. (15).

(15) a. **Directional Swedish constructions**

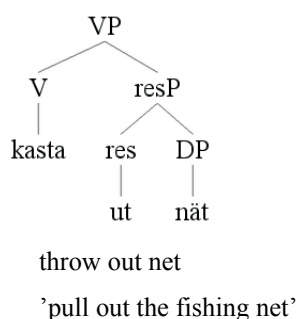

RQ 10 relaunch an old idea by Hoekstra (1992) and den Dikken (1992), namely that the particle alternation could be interpreted as the result of bilingualism. More concretely, in the Norwegian context, I suggest that the alternation in written Norwegian is the result of a mixture of the Danish RPrt grammar and the spoken Norwegian LPrt grammar (cf. Roeper's 1999 definition of bilingualism), and that the former's influence on the latter is due to the general strong position written Danish has had in Norway from the 16th century onwards (cf. Berg 2013: 199ff, Fet 2003: 388). The first serious alternative to *write* LPrt in Norwegian was

probably given in Ivar Aasen's (1864) *Nynorsk* prescriptive grammar. But even the *Nynorsk* standard has rejected productive spoken Norwegian patterns (e.g., interrogative V3 (Eide & Åfarli 2007) and light pronoun LPr constructions), and RPr has always been a satisfactory alternative in *Nynorsk*. Writing any of the Norwegian standards is therefore to master the conventions of a syntax based on both spoken Norwegian and written Danish.

The VPr puzzle has been discussed a lot in generative grammar over the years;¹⁸⁷ the discussion goes back to Chomsky's early (1955) work. There are several empirical challenges concerning VPr constructions within the North-Germanic languages (e.g., the alternation problem), but in many cases the fundamental questions boil down to the following two (cf. Jackendoff 2002: 88):

- (16) What is the relation between V and Pr?
- (17) What is the relation between Pr and the DP?

As discussed in the introduction of chapter 3, the theoretical approaches to VPr constructions can roughly be divided into two groups, whether they primarily deal with question (16) or (17) (cf. Ramchand & Svenonius 2002). Since I have placed myself in the SC camp, I primarily deal with (17). However, by suggesting the presence of DynP, I have tried to define a position syntactically adjacent to V, and thereby also to answer (16) more satisfactorily. By eventually defending a representational model, I have thoroughly examined the structural vs. general-conceptual relation between Pr and the DP.

My goal in this thesis has been to show empirically that this kind of structural and general-conceptual semantics plays a crucial role in VPr constructions.

¹⁸⁷ See, e.g., Nicole Dehé's comprehensive VPr bibliography available online at <<http://ling.uni-konstanz.de/pages/home/dehe/bibl/PV.html>> (accessed November 2014).

References

- Aa, L. I. (2004). *Gul oppgåve med svarte striper (på) – om relativtiktige småsetningar innleidde av med*. MA thesis, NTNU, Trondheim.
- Aa, L.I. (2006). “Med som innleiande funksjonsord til småsetningar med og utan relativisering”. *Norsk lingvistisk tidsskrift* 2, 2006: 193–228.
- Aa, L.I. (2008). ”Med”. *Norsk Ordbok.Ordbok over det norske folkemålet og det nynorske skriftmålet*. O. Grønvik, L. Killingbergtrø, L.S. Vikør & D. Worren (main eds.): 1208–1217. Oslo: Samlaget.
- Aa, L.I. (2009a). ”Opp”. *Norsk Ordbok.Ordbok over det norske folkemålet og det nynorske skriftmålet*. O. Grønvik, L.S. Vikør & D. Worren (main eds.): 790–796. Oslo: Samlaget.
- Aa, L.I. (2009b). ”På”. *Norsk Ordbok.Ordbok over det norske folkemålet og det nynorske skriftmålet*. O. Grønvik, L.S. Vikør & D. Worren (main eds.): 1530–1542. Oslo: Samlaget.
- Aa, L.I. (2011). “Partiklar inn i ordbøkene? Om tradisjonell og nyare kategorisering av preposisjonar”. *LexicoNordica* 18: 249–266.
- Aa, L.I. (2012). ”Ordbøker handlar ikkje om språk”. *Riss* 2/2012, 51–59. Trondheim: NTNU.
- Aa, L.I. (2013). ”Er ordbøker lingvistiske nok? Om preposisjonssemantikk og ein grammatisk basis for ordboksartiklar”. *LexicoNordica* 20: 145–163.
- Aa, L.I. (2014). “Å ikkje akte infinitivsmarket”. *Frå A til Å. Veneskrift til Dagfinn Worren på 70-årsdagen 28. desember 2014*. O. Almenningen, O. Grønvik, H.U. Karlsen, A. Tandberg, L.S. Vikør & Å. Wetås (eds.): 135–138. Oslo: Novus.
- Aa, L.I. (in press). ”Mangfald og einskap med preposisjonar – og vitskaplege krav til moderne ordbøker”. *Ivar Aasen ute og heime – om moderne språkdokumentasjon etter Ivar Aasen*. J.R. Hagland & Å. Wetås (eds.). Trondheim: *Det Kongelige Norske Videnskabers Selskabs Skrifter*, vol. 1/ 2015.
- Aa, L.I., K.M. Eide & T.A. Åfarli (2014). ”Somme mytar er fort avkledde: perfektum partisipp i dialektkorpuset”. *Språk i Norge og nabolanda. Ny forskning om talespråk*. J.B. Johannessen & K. Hagen (eds.): 217–239. Oslo: Novus.
- Aarts, B. (1989). ”Verb-Preposition Constructions and Small Clauses in English”. *Journal of Linguistics* 25: 277–280.

- Abney, S.P. (1987). *The English Noun Phrase in Its Sentential Aspect*. Doctoral dissertation, MIT.
- Abrahamsen, J.E. (2003). *Ein vestnorsk intonasjonsfonologi*. Doctoral dissertation, NTNU, Trondheim.
- Adger, D. (2003). *Core Syntax. A Minimalist Approach*. New York: Oxford University Press.
- Åfarli, T.A. (1985). "Norwegian Verb Particle Constructions as Causative Constructions". *Nordic Journal of Linguistics* 8: 75–98.
- Åfarli, T.A. (1992). *The Syntax of Norwegian Passive Constructions*. Amsterdam: John Benjamins.
- Åfarli, T.A. (2000). *Grammatikk – kultur eller natur? Elementær innføring i det generative grammatikkstudiets vitenskapsteori*. Oslo: Det norske samlaget.
- Åfarli, T.A. (2007). "Do Verbs Have Argument Structure?" *Argument Structure*. E. J. Reuland, T. Bhattacharya & G. Spathas (eds.): 1–16. Amsterdam: John Benjamins.
- Åfarli, T.A. (2012). "Hybride verbformer i amerikanorsk og analyse av tempus". *Norsk lingvistisk tidsskrift* 30: 380–398.
- Åfarli, T.A. & K.M. Eide (2000). "Subject Requirement and Predication". *Nordic Journal of Linguistics* 23: 27–48.
- Åfarli, T.A. & K.M. Eide (2003). *Norsk generativ syntaks*. Oslo: Novus.
- Åfarli, T. A., M. B. Grimstad & K. Subbarao (2013). "Dakkhini and the Problem of a Matrix Language Frame in Sustained Syntactic Contact". *International Conference on Language Contact in India. Historical, Typological and Sociolinguistic Perspectives, 6–8 February 2013*. Pune, India: Deccan College Post Graduate & Research Institute: xliv–lvii.
- Aksnes, M. (2003). *Konstruksjoner med formelt subjekt i stavangerdialekten*. MA thesis, NTNU, Trondheim.
- Alexiadou, A. & E. Anagnostopoulou (1995). "SVO and EPP in Null Subject Languages and Germanic". *FAS Papers in Linguistics* 4: 1–21.
- Almenningen, O. & A. Søyland (2012). *Praktisk nynorsk for lærarstudentar*. Oslo: Samlaget.
- Anderson, M. (2010). *Med [blikket på mæ]. Ein syntaktisk analyse av spatiale preposisjonar og kasus i vestnesdialekten*. MA thesis, NTNU, Trondheim.
- Aasen, I. (1848). *Det norske Folkesprogs Grammatik*. Christiania: Werner & Comp.
- Aasen, I. (1850 [2000]). *Ordbog over det norske Folkesprog*. K. Kruken & T. Aarset (eds.). Oslo: Samlaget.

- Aasen, I. (1853). *Prøver af Landsmaalet i Norge*. Digital edition from 1997 available at <http://www.aasentunet.no/filestore/Ivar_Aasen-tunet/Ivar_Aasen/Dikt_og_verk/Sentrale_verk/PrverafLandsmaalet.pdf> (accessed December 2014). Oslo: Samlaget.
- Aasen, I. (1864). *Norsk Grammatik*. Christiania: Malling.
- Aasen, I. (1873 [2003]). *Norsk Ordbog med dansk Forklaring*. K. Kruken & T. Aarset (eds.). Oslo: Samlaget.
- Askedal, J.O. (1986). "On Ergativity in Modern Norwegian". *Nordic Journal of Linguistics* 9: 25–45.
- Baker, Mark (1988). *Incorporation. A Theory of Grammatical Function Changing*. Chicago: The University of Chicago Press.
- Barbiers, S. (2013). "Microsyntactic Variation". *The Cambridge Handbook of Generative Syntax*. M. den Dikken (ed.): 899–926. Cambridge: Cambridge University Press.
- Bech, E. (1998). *Det-konstruksjoner og løfting med utgangspunkt i psykologiske predikater*. MA thesis, NTNU, Trondheim.
- Beito, O.T. (1970). *Nynorsk grammatikk. Lyd- og ordlære*. Oslo: Samlaget.
- Berg, I. (2013). *Eit seinmellomalderleg skrivemiljø: Nidaros erkesete 1458–1537*. Doctoral dissertation, NTNU, Trondheim.
- Berg, I. (in press). "Geografisk og sosial variasjon før 1600". *Norsk språkhistorie II: Praksiser*. B. Mæhlum (ed.). Oslo: Novus.
- Besten, H. den, & G. Webelhuth (1990). "Stranding". *Scrambling and Barriers*, G. Grewendorf and W. Sternefeld (eds.): 77–92. Amsterdam: Benjamins.
- Beukema, F. & T. Hoekstra (1984). "Extractions from *With* Constructions". *Linguistic Inquiry* 15: 689–698.
- Bobaljik, J.D. & S. Brown (1997). "Interarboreal Operations: Head Movement and the Extension Requirement". *Linguistic Inquiry* 28: 345–356.
- Bobaljik, J. D. & D. Jonas (1996). "Subject Positions and the Role of SpecTP". *Linguistic Inquiry* 27: 195–236.
- Boeckx, C. (2006). *Linguistic Minimalism. Origins, Concepts, Methods, and Aims*. Oxford: Blackwell Publishers.
- Boeckx, C. (2010). "Defeating Lexicocentrism. Outline of Elementary Syntactic Structures". Second draft, October 2010. Available at <<http://ling.auf.net/lingbuzz>> (accessed October 2014).

- Boeckx, C. (2011). "Approaching parameters from below". *The biolinguistic Enterprise. New Perspectives on the Evolution and Nature of the Human Language Faculty*. A.M. Di Ciullo & C. Boeckx (eds): 205–221. Oxford: Oxford University Press.
- Borer, H. (1984). *Parametric Syntax: Case Studies in Semitic and Romance Languages*. Dordrecht: Foris.
- Borer, H. (1998). "Deriving Passives without Theta Roles". *Morphology and Its Relation to Phonology and Syntax*. S.G. Lapointe, D.K. Brentari & P.M. Farrell (eds.): 60–111. Stanford: CSLI Publications.
- Borer, H. (2005). *Structuring Sense*, vol. I & II. Oxford: Oxford University Press.
- Borer, H. (2013). *Structuring Sense*, vol. 3: Taking Form. Oxford: Oxford University Press.
- Bouchard, D. (1995). *The Semantics of Syntax. A Minimalist Approach to Grammar*. Chicago: The University of Chicago Press.
- Bowers, J. (1993). "The Syntax of Predication". *Linguistic Inquiry* 24: 591–656.
- Bruening, B. (2010). "Ditransitive Assymetries and a Theory of Idiom Formation". *Linguistic Inquiry* 41: 519–562.
- Bull, T. (2009). "Knot". *I mund og bog. 25 artikler om sprog tilegnet Inge Lise Pedersen på 70-årsdagen d. 5. juni 2009*. H. Hovmark, I.S. Sletten & A. Gudiksen (eds.): 47–58. Afdeling for Dialektforskning, Nordisk Forskningsinstitut, Københavns Universitet.
- Burzio, L. (1986). *Italian Syntax: A Government-Binding Approach*. Dordrecht: Reidel.
- Carlson, G. (1977). *Reference to Kinds in English*. Doctoral dissertation, Amherst: University of Massachusetts.
- Carrier, J. & J.H. Randall (1992). "The Argument Structure and Syntactic Structure of Resultatives". *Linguistic Inquiry* 23: 173–234.
- Chambers, J. K. & P. Trudgill (1980). *Dialectology*. Cambridge: Cambridge University Press.
- Chomsky, N. (1955). *The Logical Structure of Linguistic Theory*. Ms. MIT.
- Chomsky, N. (1957). *Syntactic Structures*. The Hague: Mouton.
- Chomsky, N. (1959). "A Review of B.F. Skinner's *Verbal Behavior*". *Language* 35: 26–58.
- Chomsky, N. (1965). *Aspects of the Theory of Syntax*. Cambridge, MA: MIT Press.
- Chomsky, N. (1970). "Remarks on Nominalization". R. Jacobs & P. Rosenbaum (eds.) *Readings in English Transformational Grammar*. Waltham, MA: Ginn.
- Chomsky, N. (1981). *Lectures on Government and Binding. The Pisa Lectures*. Dordrecht: Foris.
- Chomsky, N. (1982). *Some Concepts and Consequences of the Theory of Government and Binding*. Cambridge, MA: MIT Press.

- Chomsky, N. (1986). *Barriers*. Cambridge, MA: MIT Press.
- Chomsky, N. (1993). "A Minimalist Program for Linguistic Theory". *View from Building 20. Essays in Linguistics in Honor of Sylvain Bromberger*. K. Hale & S.J. Keyser (eds.): 1–52. Cambridge, MA: MIT Press.
- Chomsky, N. (1995). *The Minimalist Program*. Cambridge, MA: MIT Press.
- Chomsky, N. (2000). "Minimalist Inquiries": The Framework". *Step by Step: Essays on Minimalist Syntax in Honor of Howard Lasnik*. R. Martin, D. Michaels & J. Uriagereka (eds.): 89–55. Cambridge, MA: MIT Press.
- Chomsky, N. (2001). "Derivation by Phase". *Ken Hale: A Life in Language*. M. Kenstovicz (ed.): 1–54. Cambridge, MA: MIT Press.
- Chomsky, N. (2005). "Three Factors in Language Design". *Linguistic Inquiry* 36: 1–22.
- Chomsky, N. (2007). "Approaching UG from Below". *Interfaces + Recursion = Language? Chomsky's Minimalism and the View from Syntax–Semantics*. U. Sauerland & H.M. Gärtner (eds.): 1–29. Berlin: Mouton de Gruyter.
- Chomsky, N. (2008). "On Phases". *Foundational Issues in Linguistic Theory*. R. Freidin, C. Otero & M.L. Zubizarreta (eds.): 133–166. Cambridge, MA: MIT Press.
- Chomsky, N. & H. Lasnik (1977). "Filters and Control". *Linguistic Inquiry* 8: 425–504.
- Christensen, K.C. (1996). "Mikrokomparativisme og målføresyntaks". *Nordica Bergensia* 9, 1996. Ø.A. Vangsnes (ed.): 15–23. University of Bergen.
- Clark, E.V. & H.H. Clark (1979). "When Nouns Surface as Verbs". *Language* 55: 767–811.
- Cohen, L.J. (1981). "Some Remarks on the Nature of Linguistic Theory". *Philosophical Transactions of the Royal Society of London*: 235–243. Reprinted in *The Psychological Mechanisms of Language: A Joint Symposium of the Royal Society and the British Academy*. London: The Royal Society and the British Academy.
- Cornips, L. & C. Poletto (2005). "On Standardising Syntactic Elicitation Techniques, part 1". *Lingua* 115: 939–957.
- Dalen, A. (2008). "Trøndermåla frå vår tid og tilbake til reformasjonen" (first part). *Trøndersk språkhistorie. Språkforhold i ein region*: 13–140. Trondheim: Tapir Academic Press.
- Dehé, N. (2002). *Particle Verbs in English: Syntax, Information Structure, and Intonation*. Amsterdam: John Benjamins.
- Dikken, M. den (1992). *Particles*. Doctoral dissertation. Holland Institute of Generative Linguistics.

- Dikken, M. den (1995). *Particles. On the Syntax of Verb-Particle, Triadic, and Causative Constructions*. New York: Oxford University Press.
- Dikken, M. den (2002). "Book Review". *Journal of Comparative Germanic Linguistics* 4: 145–169.
- Doron, E. & C. Heycock (1999). "Filling and Licensing Multiple Specifiers". *Specifiers: Minimalist Approaches*. D. Adger, S. Pintzuk, B. Plunkett & G. Tsoulas (eds.): 66–89. Oxford: Oxford University Press.
- Dowty, D. (1991). "Thematic Proto-Roles and Argument Selection". *Language* 67: 547–619.
- Dryer, M.S. (1989). "Discourse-Governed Word Order and Word Order Typology". *Belgian Journal of Linguistics* 4: 69–90.
- Dryer, M.S. (1995). "Frequency and Pragmatically Unmarked Word Order". *Word Order in Discourse*. P. Downing & N. Noonan (eds.): 105–136. Amsterdam: John Benjamins.
- Eide, K.M. & T.A. Åfarli (1999). "Semantically Charged Syntax and the Construction of Meaning". *University of Pennsylvania Working Papers in Linguistics*, vol. 6: 111–126.
- Eide, K.M. & T.A. Åfarli (2007). "Flerspråklighet – en utfordring for det generative rammeverket? – Om dialektsyntaks og parallelle grammatikker". *Nordisk dialektologi og sociolingvistik, Foredrag på 8. Nordiske Dialektologkonferanse, Århus 15.–18. august 2006*. T. Arboe (ed.): 126–135. Århus: Peter Skautrup Centret for Jysk Dialektforskning.
- Emonds, J. (1976). *A Transformational Approach to English Syntax*. New York: Academic Press.
- Endresen, Ø. (1988). "Innbyrdes posisjon mellom trykklett pronomen og setningsadverbialet *ikkje* i trønderske og nordsvenske dialekter". *Nordiske studiar. Innlegg på den tredje dialektologkonferansen 1986*. A. Bjørkum & A. Borg (eds.): 47–70. Oslo: Universitetsforlaget.
- Falk, H. & A. Torp (1900). *Dansk-norskens syntax*. Kristiania: H. Aschehoug & Co.
- Faarlund, J.T. (1974). "Preposisjonsuttrykk innledet av *med* i moderne norsk". *Norsk lingvistisk tidsskrift* 28: 45–62.
- Faarlund, J.T. (1977). "Transformational Syntax in Dialectology: Scandianavian Word Order Varieties". *Papers from the Trondheim Syntax Symposium*. T. Fretheim & L. Hellan (eds.): 65–83.
- Faarlund, J.T. (2003). "Reanalyse og grammatikalisering i norske infinitivskonstruksjonar". *Språk i endring. Indre norsk språkhistorie*. J.T. Faarlund (ed.): 57–79. Oslo: Novus.

- Faarlund, J.T. (2007). "Parameterization and Change in Non-Finite Complementation". *Diacronica* 24 (1): 57–80.
- Faarlund, J.T., Vannebo, K.I. & Lie, S. (1997). *Norsk referansegrammatikk*. Oslo: Universitetsforlaget.
- Fet, J. (1995). *Lesande bønder. Litterær kultur i norske allmugesamfunn før 1840*. Oslo: Universitetsforlaget.
- Fet, J. (2003). *Skrivande bønder. Skrifkultur på Nord-Vestlandet 1600–1850*. Oslo: Samlaget.
- Fraser, B. (1976). *The Verb-Particle Combination in English*. New York: Academic Press.
- Garbacz, P. (2010). *Word Order in Övdalian. A Study in Word Order and Change*. Doctoral dissertation, University of Lund.
- Garbacz, P. (2011). "Sambandet mellom morfologi och syntax i de nordiska dialekterna". *Studier i dialektologi och språksociologi. Föredrag vid Nionde nordiska dialektologkonferensen i Uppsala 18-20 augusti 2010*. L. Elmevik, L.E. Edlund & M. Reinhammar (eds.): 113–121. Acta Academiae Regiae Gustavi Adolphi 116.
- Goldberg, A.E. (1995). *Constructions. A Construction Grammar Approach to Argument Structure*. Chicago: The University of Chicago Press.
- Goldberg, A.E. (2006). *Constructions at Work*. Oxford: Oxford University Press.
- Grepstad, O. (2012). *Språkfakta Sogn og Fjordane 1646–2012*. Report available at <<http://www.aasentunet.no/iaa/no/>> (accessed October 2014).
- Grepstad, O. (2013). *Historia om Ivar Aasen*. Oslo: Samlaget.
- Grimstad, M.B., T. Lohndal & T.A. Åfarli (2014). "Language Mixing and Exoskeletal Theory: A Case Study of Word-Internal Mixing in American Norwegian". Ms., NTNU, Trondheim.
- Haegeman, L. (1994). *Introduction to Government and Binding Theory* (2nd ed.). Oxford: Blackwell.
- Hale, K. & S.J. Keyser (1993). "On Argument Structure and the Lexical Expression of Syntactic Relations". *The view from Building 20: Essays in Linguistics in Honor of Sylvain Bromberger*. K. Hale & S.J. Keyser (eds.): 53–110. Cambridge, MA: MIT Press.
- Haugen, E. (1931). *The Origin and Early History of the New Norse Movement in Norway*. Doctoral dissertation, University of Illinois.
- Haugen, E. (1933 [1972]). "The Linguistic Development of Ivar Aasen's New Norse". *Studies by Einar Haugen. Presented on the Occasion of His 65th Birthday – April 19, 1971*. E.S. Firchow, K. Grimstad, N. Hasselmo & W.A. O'Neill (eds.): 25–57. Mouton: The Hague.

- Heggstad, L. (1931). *Norsk grammatikk. Større utgåve*. Oslo: Olaf Norlis Forlag.
- Hellan, L. (1982). "Semantic and Functional Government of Reflexives in Norwegian". *Papers from the Sixth Scandinavian Conference of Linguistics*. T. Fretheim & L. Hellan (eds.): 60–74. Trondheim: Tapir.
- Hellan, L. (1988). *Anaphora in Norwegian and the Theory of Grammar*. Dordrecht: Foris.
- Hellan, L. & K.C. Christensen (1986). "Introduction". *Topics in Scandinavian Syntax*. L. Hellan & K.C. Christensen (eds.): 1–29. Dordrecht: D. Reidel Publishing Company.
- Henry, A. (1995). *Belfast English and Standard English. Dialect Variation and Parameter Setting*. New York: Oxford University Press.
- Hoekstra, T. (1988). "Small Clause Results". *Lingua* 74: 101–139.
- Holmberg, A. (2010). "Parameters in Minimalist Theory: The Case of Scandinavian". *Theoretical Linguistics* 36: 1–48.
- Holmberg, A. & C. Platzack (1995). *The Role of Inflection in Scandinavian Syntax*. New York: Oxford University Press.
- Hornstein, N., J. Nunes & K.K. Grohmann (2005). *Understanding Minimalism*. Cambridge: Cambridge University Press.
- Hosono, M. (2014). "Scandinavian Verb Particle Constructions and the Intonational Properties". *Working Papers in Scandinavian Syntax* 93: 102–136.
- Hovdenak, M., L. Killingbergtrø, A. Lauvhjell, S. Nordlie, M. Rommetveit & D. Worren (2006). *Nynorskordboka. Definisjons- og rettskrivingsordbok* (4th ed.). Oslo: Samlaget.
- Huang, C.-T.J. (1982). "Move WH in a Language without WH movement". *The Linguistic Review* 1: 369–416.
- Hulthén, L. (1948). *Studier i jämförande nordisk syntax*, volum LIII. Göteborg: Elanders Boktryckeri Aktiebolag.
- Indrebø, G. (1947). *Norsk målsøge*. Bergen: A.S. Lunde & Co.s Forlag.
- Indrehus, K.L. (2014). «Eg er berre bergensar når eg snakkar med systema mi». *Ein kvalitativ studie av samanhengen mellom identitet og talemål hos bidialektale*. MA thesis, NTNU, Trondheim.
- Jackendoff, R.S. (1983). *Semantics and Cognition*. Cambridge, MA: MIT Press.
- Jackendoff, R.S. (1990). *Semantic Structures*. Cambridge, MA: MIT Press.
- Jackendoff, R.S. (2002). "English Particle Constructions, the Lexicon, and the Autonomy of Syntax". *Verb-Particle Explorations*. N. Dehé, R.S. Jackendoff, A. McIntyre & S. Urban (eds.): 67–94. Berlin: Mouton de Guyter.
- Jespersen, O. (1924). *The Philosophy of Grammar*. London: George Allen & Unwin.

- Jespersen, O. (1940). *Modern English Grammar. On Historical Principles. Part V: Syntax. Fourth Volume*. London: George Allen & Unwin and Ejnar Munksgård.
- Johannessen, J.B. (2003). "Innsamling av språklige data. Informanter, introspeksjon og korpus". *På språkjakt – problemer og utfordringer i språkvitenskapelig datainnsamling*. J.B. Johannessen, S. Erlenkamp, E. Lanza & A.M. Vonen (eds.): 133–171. Oslo: Unipub forlag.
- Johannessen, J.B. (2009a). "Spoken Language Corpora, with Special Focus on The Nordic Dialect Corpus". Paper at *Infrastructural Tools for the Study of Linguistic Variation*. PhD training course at Fefor Høifjellshotell, Gudbrandsdalen, Norway, June 2–6, 2009.
- Johannessen, J.B. (2009b). "The ScanDiaSyn Nordic Dialect Corpus and Nordic Syntax Database". Paper at *The 5th Grand Meeting for the Network for ScanDiaSyn*. Älvdalen, Sweden, August 24–28, 2009.
- Johannessen, J.B. & K. Hagen (2014). "Om artiklene i denne boka og *Nordisk dialektkorpus*". *Språk i Norge og nabolanda. Ny forskning og talespråk*. J.B. Johannessen & K. Hagen (eds.): 7–25. Oslo: Novus.
- Johannessen, J.B., J. Priestley, K. Hagen, T.A. Åfarli & Ø.A. Vangsnes (2009). "The Nordic Dialect Corpus – An Advanced Research Tool". *Proceedings of the 17th Nordic Conference of Computational Linguistics, NODALIDA 2009*. K. Jokinen & E. Bick (eds.): 73–80.
- Kayne, R.S. (1984). *Connectedness and Binary Branching*. Dordrecht: Foris Publications.
- Kayne, R.S. (1985). "Principles of Particle Constructions". *Grammatical Representation*. J. Gueron, H.G. Obenhauer & J.Y. Pollock (eds.): 101–140. Dordrecht: Foris.
- Kayne, R.S. (1993). "Toward a Modular Theory of Auxiliary Selection". *Studia Linguistica* 47.1: 3–31.
- Kayne, R.S. (1994). *The Antisymmetry of Syntax*. Cambridge, MA: MIT Press.
- Kayne, R.S. (2000). *Parameters and Universals*. Oxford: Oxford University Press.
- Kayne, R.S. (2005). "Some Notes on Comparative Syntax, with Special Reference to English and French". *The Oxford Handbook of Comparative Syntax*. G. Cinque & R.S. Kayne (eds.): 3–69. Oxford: Oxford University Press.
- Kitahara, H. (1997). *Elementary Operations and Optimal Derivations*. Cambridge, MA: MIT Press.
- Koizumi, M. (1995). *Phrase Structure in Minimalist Syntax*. Doctoral dissertation, MIT.
- Kuno, S. (1973). *The Structure of the Japanese Language*. Cambridge, MA: MIT Press.

- Larson, R.K. (1988). "On the Double Object Construction". *Linguistic Inquiry* 19: 335–381.
- Lasnik, H. (2001). "Derivation and Representation in Modern Transformational Syntax". *The Handbook of Contemporary Syntactic Theory*. M. Baltin & C. Collins (eds.): 62–88. Malden, MA: Blackwell Publishing.
- Lasnik, H. & T. Lohndal (2013). "Brief Overview of the History of Generative Syntax". *The Cambridge Handbook of Generative Syntax*. M. den Dikken (ed.): 26–60. Cambridge: Cambridge University Press.
- Levin, B. (1993). *English Verb Classes and Alternations. A Preliminary Investigation*. Chicago: The University of Chicago Press.
- Li, Y. (1990). "X⁰-binding and Verb Incorporation". *Linguistic Inquiry* 21: 399–426.
- Lindstad, A.M., A. Nøklestad, J.B. Johannessen & Ø.A. Vangsnes (2009). "The Nordic Dialect Database: Mapping Microsyntactic Variation in the Scandinavian Languages". *Proceedings of the 17th Nordic Conference of Computational Linguistics, NODALIDA 2009*. K. Jokinen & E. Bick (eds.): 283–286.
- Lohndal, T. (2012). *Without Specifiers: Phrase Structure and Events*. Doctoral dissertation, University of Maryland.
- Lohndal, T. (2014). *Phrase Structure and Argument Structure. A Case Study of the Syntax-Semantics Interface*. Oxford: Oxford University Press.
- Lundquist, B. (2012). "Turning Objects into Paths in English and Mainland Scandinavian". Paper at the *N'CLAV Meeting*, August 13–16, 2012, Lysebu, Oslo.
- Marantz, A. (1984). *On the Nature of Grammatical Relations*. Cambridge, MA: MIT Press.
- Marantz, A. (1997). "No Escape from Syntax. Don't Try Morphological Analysis in the Privacy of Your Own Lexicon". *Proceedings of the 21st Annual Penn Linguistics Colloquium*. A. Dimitriadis, L. Siegel, C. Surek-Clark & A. Williams (eds.): 201–225. Philadelphia: University of Pennsylvania.
- Marantz, A. (2013). "Verbal Argument Structure: Events and Participants". *Lingua* 130: 152–168.
- Mæhlum, B. & U. Røyneland (2009). "Dialektparadisene Norge – en sannhet med modifikasjoner". *I mund og bog. 25 artikler om sprog tilegnet Inge Lise Pedersen på 70-årsdagen d. 5. juni 2009*. H. Hovmark, I.S. Sletten & A. Gudiksen (eds.): 219–229. Afdeling for Dialektforskning, Nordisk Forskningsinstitutt, Københavns Universitet.
- Mæhlum, B. & U. Røyneland (2013). *Det norske dialektlandskapet*. Oslo: Cappelen akademisk forlag.
- Neeleman, A. (1994). *Complex Predicates*. Doctoral dissertation, Utrecht University.

- Newmeyer, F.J. (1983). *Grammatical Theory. Its Limits and Its Possibilities*. Chicago: The University of Chicago Press.
- Newmeyer, F.J. (1986). *The Politics of Linguistics*. Chicago: The University of Chicago Press.
- Newmeyer, F.J. (1998). *Language Form and Language Function*. Cambridge, MA: MIT Press.
- Newmeyer, F.J. (2005). *Possible and Probable Languages. A Generative Perspective on Linguistic Theory*. Oxford: Oxford University Press.
- Newmeyer, F.J. (2006). "A Rejoinder to 'On the Role of Parameters in Universal grammar; a Reply to Newmeyer' by Ian Roberts and Anders Holmberg". Ms. (February 2006 version), University of Washington.
- Nilsen, R.A. (2003). "Intonologi". *Norsk generativ syntaks*. T.A. Åfarli & K.M. Eide: 314–331. Oslo: Novus.
- Nilsen, B.H. (2005). «Er det virkelig deg?» *Om identitetsrealisering hos personer med to internaliserte dialekter*. MA thesis, Agder University College, Kristiansand.
- Nordgård, K.A. (2002). *Presenteringssetninger i en småsetningsanalyse*. MA thesis, NTNU, Trondheim.
- Nordgård, T. & T.A. Åfarli (1990). *Generativ syntaks – ei innføring via norsk*. Oslo: Novus.
- Norsk Ordbok. Ordbok over det norske folkemålet og det nynorske skriftmålet*. (1966–). Oslo: Det Norske Samlaget.
- Nygård, M. (2004). *Talespråkssyntaks. En analyse av elliptiske konstruksjoner i talespråk*. MA thesis, NTNU, Trondheim.
- Nygård, M. (2013). *Discourse Ellipsis in Spontaneously Spoken Norwegian*. Doctoral dissertation, NTNU, Trondheim.
- Oehrle, R. (1976). *The Grammatical Status of the English Dative Alternation*. Doctoral dissertation, MIT.
- Ommeren, R. van (forthcoming). *Språklige kameleoner. En sosiolingvistisk studie av språklig praksis blant norske bidialektale individer*. Doctoral dissertation, NTNU, Trondheim.
- Perlmutter, D. (1978). "Impersonal Passives and the Unaccusative Hypothesis". *Proceedings of the Fourth Annual Meeting of the Berkeley Linguistics Society*: 157–189. Berkeley: Berkeley Linguistics Society, University of California.
- Pesetsky, D. (1995). *Zero Syntax: Experiencers and Cascades*. Cambridge, MA: MIT Press.
- Platzack, Christer, 1987: The Scandinavian languages and the null-subject parameter. *Natural Language and Linguistic Theory* 5: 377–401.

- Platzack, C. (2010). *Den fantastiska grammatiken. En minimalistisk beskrivning av svenskan*. Stockholm: Norstedts.
- Platzack, C. (2011). "Towards a Minimal Argument Structure". Ms. University of Lund. Available at <<http://ling.auf.net/lingbuzz>> (accessed September 2014).
- Platzack, C. & A. Holmberg (1989). "The Role of AGR and Finiteness in Germanic VO Languages". *Working Papers in Scandinavian Syntax* 43: 51–76.
- Radford, A. (2009). *Analysing English Sentences. A Minimalist Approach*. Cambridge: Cambridge University Press.
- Ramchand, G. (2008). *Verb Meaning and the Lexicon. A First-Phase Syntax*. Cambridge University Press.
- Ramchand, G. & P. Svenonius (2002). "The Lexical Syntax and Lexical Semantics of the Verb Particle Construction". WCCFL 21 Proceedings, ed. L. Mikkelsen & C. Potts, 101–114. Somerville, MA: Cascadilla Press. Also available at <<http://ling.auf.net/lingbuzz>> (accessed December 2014).
- Rappaport Hovav, M. & B. Levin (1985). "A Case Study in Lexical Analysis: The Locative Alternation". Unpublished ms., Lexicon Project, Center for Cognitive Science, MIT, Cambridge, MA.
- Rappaport Hovav, M. & B. Levin (1988). "What to Do with Theta-Roles". *Syntax and Semantics 21: Thematic relations*. W. Wilkins (ed.): 7–36. New York: Academic Press.
- Rizzi, L. (1978). "Violations of the Wh-Island Constraint in Italian and the Subjacency Condition". *Montreal Working Papers in Linguistics* 11: 155–190.
- Rizzi, L. (1982). *Studies in Italian Syntax*. Dordrecht: Foris
- Rizzi, L. (1990). *Relativized Minimality*. Cambridge, MA: MIT Press.
- Roberts, I. (2010). *Agreement and Head Movement. Clitics, Incorporation, and Defective Goals*. Cambridge, MA: MIT Press.
- Roberts, I. & A. Holmberg (2010). "Introduction: Parameters in Minimalist Theory". *Null Subjects: The Structure of Parametric Variation*. T. Biberauer, A. Holmberg, I. Roberts & M. Sheehan (eds.): 1–57. Cambridge: Cambridge University Press.
- Roeper, T. (1999 [2007]). *The Prism of Grammar. How Child Language Illuminates Humanism*. Cambridge, MA: MIT Press.
- Rognes, S. (2011). *V2, V3, V4 (and Maybe Even More). The Syntax of Questions in the Rogaland Dialects of Norwegian*. MA thesis, University of Oslo.

- Rosenkvist, H. (2004). *The Emergence of Conditional Subordinators in Swedish – a Study in Grammaticalization*. Doctoral dissertation, University of Lund.
- Ross, H. (1895). *Norsk Ordbog. Tillæg til «Norsk Ordbok» av Ivar Aasen*. Oslo: Grøhndal & Søn. New ed. in 1971 by Universitetsforlaget.
- Sandøy, H. (1974). "Eit språk i kamp. Om færøysk målreising". *Mål og makt* 3, 1974: 2–21.
- Sandøy, H. (1976). *Laust samansette verb i vestnordisk: ein samanliknande leddstillingsanalyse for islandsk, færøysk og romsdalsmål*. Magister dissertation, University of Oslo. Available online at <<http://folk.uib.no/hnohs/Publikasjonar.html>> (accessed October 2014).
- Sandøy, H. (1988). "Samsvarbøying av adjektiv og perfektum partisipp i norske dialektar". *Nordiske studiar. Innlegg på den tredje nordiske dialektologkonferansen 1986*. A. Bjørkum & A. Borg (eds.): 85–117. Oslo: Universitetsforlaget.
- Sandøy, H. (1985). *Norsk dialektkunnskap*. Oslo: Novus.
- Sandøy, H. (1994). "Talesyntaks og dialektsyntaks". *Helsing til Lars Vassenden på 70-årsdagen*. J. Myking, H. Sandøy & I. Utne (eds.): 195–206. Bergen: University of Bergen.
- Sawyer, J. (1999). *Verb Adverb and Verb Particle Constructions: Their Syntax an Acquisition*. Unpublished doctoral dissertation, Boston University.
- Schütze, C.T. (1996). *The Empirical Base of Linguistics. Grammaticality Judgements and Linguistic Methodology*. Chicago: The University of Chicago Press.
- Schütze, C.T. (2010). "Linguistic Evidence and Grammatical Theory". *WIREs (Wiley Interdisciplinary Reviews) Cognitive Science* 2: 206–221.
- Seuren, P.A.M. (1998). *Western Linguistics. An Historical Introduction*. Malden, MA: Blackwell Publishing.
- Skaalbones, L.K. (2006). *Henger de på? Prososyntaktiske trekk ved verbpartikler i en nordnorsk høytonedialekt*. MA thesis, NTNU, Trondheim.
- Skinner, B.F. (1957). *Verbal Behavior*. New York: Appleton-Century-Crofts.
- Skomedal, T. (1981). "Det færøyske skriftmålet". *Færøyene – frendeland i vest*, S.Stove (ed.). Oslo: Norsk-Færøysk Lag.
- Smári, J.J. (1920). *Íslenzk setningafræði*. Reykjavik: Bókaverzlun Ársæls Árnasonar.
- Snyder, W. (2000). "An Experimental Investigation of Syntactic Satiation Effects". *Linguistic Inquiry* 31: 575–582.
- Sprouse, J. & D. Almeida (2012). "Assessing the Reliability of Textbook Data in Syntax: Adger's *Core Syntax*". *Journal of Linguistics* 48: 609–658.

- Sprouse, J, C.T. Schütze & D. Almeida (2013). "A Comparison of Informal and Formal Acceptability Judgments Using a Random Sample from *Linguistic Inquiry* 2001–2010". *Lingua* 134: 219–248.
- Stabler, E. (1999). "Remnant Movement and Structural Complexity". *Constraints and Resources in Natural Language Syntax and Semantics*, CSLI 1999. G. Bouma, E. Hinrichs, G.-J. Kruijff, and R. Oehrle (eds.): 299–326.
- Stowell, T. (1981). *Origins of Phrase Structure*. Doctoral dissertation, MIT.
- Stowell, T. (1983). "Subjects across Categories". *The Linguistic Review* 2: 285–312.
- Sveen, A. (1996). *Norwegian Impersonal Actives and the Unaccusative Hypothesis*. Doctoral dissertation, University of Oslo.
- Svenonius, P. (1992). "Movement of P⁰ in the English Verb-Particle Construction". *Syntax at Santa Cruz*, vol. 1, A. Black and J. McCloskey (eds.): 93–113. Santa Cruz, CA: University of California at Santa Cruz.
- Svenonius, P. (1994). *Dependent Nexus: Subordinate Predication Structures in English and the Scandinavian Languages*. Doctoral dissertation, University of California, Santa Cruz.
- Svenonius, P. (1996a). "The Verb-Particle Alternation in the Scandinavian Languages". Available at <<http://ling.auf.net/lingbuzz>> (accessed September 2014).
- Svenonius, P. (1996b). "The Optionality of the Verb-Particle Construction". *Working Papers in Scandinavian Syntax* 57: 47–75.
- Svenonius, P. (2001). "Case and Event Structure". *ZASPIL* 26. Available at <<http://www.zas.gwz-berlin.de/201.html?&L=1>> (accessed September 2014).
- Svenonius, P. (2003). "Swedish Particles and Directional Prepositions". *Grammar in Focus*, vol. II. L.O. Delsing, C. Falk, G. Josefsson & H. Sigurdsson: 343–351. Lund: Dept. of Scandinavian Languages.
- Svenonius, P. (2008). "Spatial P in English". G. Cinque & L. Rizzi (eds.), *Mapping Spatial PPs*: 127–160. Oxford: Oxford University Press.
- Svenonius (2010). "Microcomparison in the Nordic Languages". Paper at *NORMS Closing Seminar*, June 10, 2010, University of Tromsø.
- Talmy, L. (1972). *Semantic Structures in English and Atsugewi*. Doctoral dissertation, University of California, Berkeley.
- Talmy, L. (1985). "Lexicalization Patterns: Semantic Structure in Lexical Forms". *Language Typology and Syntactic Description* vol. III, T. Shopen (ed.): 57–149. Cambridge: Cambridge University Press.

- Talmy, L. (2000). *Toward a Cognitive Semantics* (vol. 1). Cambridge, MA: MIT Press.
- Taraldsen, K.T. (1978). "The Scope of Wh-Movement in Norwegian". *Linguistic Inquiry* 9: 623–640.
- Taraldsen, K.T. (1983). *Parametric Variation in Phrase Structure*. Doctoral dissertation, University of Tromsø.
- Thráinsson, H. (2007). *The Syntax of Icelandic*. Cambridge: Cambridge University Press.
- Toivonen, I. (2002). "Swedish Particles and Syntactic Projection". *Verb-Particle Explorations*. N. Dehé, S. Urban, A. McIntyre & R. Jackendoff (eds.): 191–209. Berlin: Mouton de Gruyter.
- Torp, A. & L.S. Vikør (2003). *Hovuddrag i norsk språkhistorie* (3rd ed.). Oslo: Gyldendal.
- Tsai, W.-T.D. (1994). "On Nominal Islands and LF Extraction in Chinese". *Natural Language and Linguistic Theory* 12: 121–175.
- Tungseth, M.E. (2008). *Verbal Prepositions and Argument Structure. Path, Place and Possession in Norwegian*. Amsterdam: John Benjamins.
- Tyler, A. & Evans, V. 2003. *The Semantics of English Prepositions. Spatial Scenes, Embodied Meaning and Cognition*. Cambridge: Cambridge University Press.
- Vangsnes, Ø.A. (1994). *The Syntactic Source and Semantic Reflexes of the Definiteness Effect*. MA thesis, University of Bergen.
- Ven, C. (1999). *En syntaktisk analyse av verbpartikler i norsk*. MA Thesis, INL, NTNU.
- Verkuyl, H.J. (1989). "Aspectual Classes and Aspectual Composition". *Linguistics and Philosophy* 12: 39–94.
- Vikner, S. (1987). "Case Assignment and Differences between Danish and Swedish". *Proceedings of the Seventh Biennial Conference of Teachers of Scandinavian Studies in Great Britain and Northern Ireland, March 23–25 1987*. R.D.S. Allan & M. Barnes: 262–281. London: University College.
- Vikner, S. (1995). *Verb Movement and Expletive Subjects in the Germanic Languages*. New York: Oxford University Press.
- Vinka, M. (1999). "Predicative and Non-Predicative Verb Particle Constructions". *WCCFL 18 Proceedings*: 570–585. Somerville, MA: Cascadilla Press.
- Vulchanova, M., M.F. Asbjørnsen, T.A. Åfarli, B.R. Riksem, J. Järvikivi & V. Vulchanov (2012). "Flerspråklighet i Norge". Report, NTNU.
- Walton, S.J. (1996). *Ivar Aasens kropp*. Oslo: Samlaget
- Western, A. (1921). *Norsk riksmåls-grammatikk*. Kristiania: H. Aschehoug & Co.

Williams, E. (1981). "On the Notions 'Lexically Related' and 'Head of a Word'". *Linguistic Inquiry* 12: 245–274.

Zeller, J. (2001). *Particle Verbs and Local Domains*. Amsterdam: John Benjamins.