



**NTNU – Trondheim**  
Norwegian University of  
Science and Technology

# 2-Braids and a categorification of the Kauffman bracket polynomial

**Marte Lovise Nilsen**

Master of Science in Mathematics

Submission date: June 2015

Supervisor: Gereon Quick, MATH

Co-supervisor: Richard Williamson, MATH

Norwegian University of Science and Technology  
Department of Mathematical Sciences



Master Thesis

**2-braids and a categorification of the  
Kauffman bracket invariant**

Marte Lovise Nilsen

June 1, 2015

---

# ABSTRACT

The discovery of the Jones polynomial invariant of knots is one of most important and influential breakthroughs in geometric topology, and indeed pure mathematics, in the last 30 years. One way to obtain it is to begin with a braid group, map this into a Temperley-Lieb algebra, and then take a Markov trace. This gives the Kauffman bracket polynomial, from which the Jones polynomial can be obtained by a slight modification.

In this master thesis, we categorify all aspects of this construction of the Kauffman bracket polynomial, working with 2-braids and their appropriate notion of isotopy, and exploring algebraic, higher categorical structures into which they assemble.



---

# SAMMENDRAG

Oppdagelsen av Jonespolynomet, en knuteinvariant, er en av de viktigste gjennombruddene i geometrisk topologi, og i ren matematikk generelt de siste 30 årene. En måte for å oppnå Jonespolynomet på, er ved å begynne med en flettegruppe ("Braid"-gruppe), avbilde denne på en Temperley-Lieb algebra, og deretter ta Markov trace av resultatet. Dette gir oss et "Kauffman bracket"-polynom, hvor vi med en liten modifikasjon kan finne Jonespolynomet.

I denne oppgaven kategoriserer vi alle aspekter ved denne konstruksjonen av "Kauffman bracket"-polynomet. Dette gjør vi ved å jobbe med 2-braids og det passende begrepet av isotopi, og utforske de høyere kategorielle strukturer som disse utgjør.



---

# ACKNOWLEDGEMENTS

I would like to express my deepest gratitude to those who have helped me complete this thesis.

I have been fortunate enough to have multiple dedicated supervisors during my education. First, I would like to thank my supervisor, Richard Williamson. He has introduced me to a branch of mathematics I have found highly interesting and intriguing. We have shared many fruitful discussions, and he has kept my motivation up. During this year, he has shown great patience in his supervision, and dedicated a lot of time and effort to help me. Without him, this thesis would simply not have existed.

My supervisor Gereon Quick has also been of great help to me, and I thank him for agreeing to be my supervisor on such short notice. Andrew Stacey supervised me the first year of my master's degree, and for that I am grateful. He taught me how a mathematician thinks, and made it possible for me to get to the level of understanding necessary for working with this type of mathematics.

Thanks also to Marius Thaulé for helping me create the illustrations for this thesis. In addition I would like to thank the staff at the mathematics department at NTNU for their help and guidance along the way.

Finally, I want to express my appreciation for my family and friends, who has always supported and encouraged me, especially my father for passing on the passion for mathematics early on, and my brother Espen who I share my interest in mathematics with. And last, but not least, I would like to thank all the friends I have made during my time in Trondheim.





---

# CONTENTS

## 1. Introduction

- 1.1. Overview . . . . .
- 1.2. Synopsis – I . . . . .
- 1.3. Synopsis – II . . . . .
- 1.4. Relationship to other work . . . . .
- 1.5. Future directions . . . . .
- 1.6. Preliminaries and foundations . . . . .

## 2. Internal algebraic structures and certain free constructions

- 2.1. Internal algebraic structures . . . . .
  - 2.1.1. Monoids . . . . .
  - 2.1.2. Commutative monoids . . . . .
  - 2.1.3. Rings . . . . .
- 2.2. Assumed free constructions . . . . .
  - 2.2.1. Free monoid on a monoidal datum internal to a category . . . . .
  - 2.2.2. Free ring on a monoidal datum internal to a category . . . . .
  - 2.2.3. Free ring on a monoid internal to a category . . . . .

## 3. A categorical framework for the Kauffman bracket

- 3.1. Categories of braids . . . . .
  - 3.1.1. The category of braids . . . . .
  - 3.1.2. Categories of braids up to isotopy . . . . .
- 3.2. Temperley-Lieb categories and Markov trace functors . . . . .
  - 3.2.1. The Temperley-Lieb category . . . . .
  - 3.2.2. The Temperley-Lieb category with respect to a datum for smoothing of braids . . . . .
  - 3.2.3. Markov trace functors . . . . .
  - 3.2.4. Constructing a datum for smoothing of braids given a 2-ring . . . . .
  - 3.2.5. Constructing a Markov trace datum given a 2-ring . . . . .

- 3.3. The Kauffman bracket invariant . . . . .
- 3.3.1. Smoothing functor . . . . .
- 3.3.2. The Kauffman bracket . . . . .
- 3.4. Examples . . . . .
- 3.4.1. Hopf link . . . . .

**4. A Kauffman bracket invariant for 2-braids in a 2-categorical framework**

- 4.1. 2-categories of 2-braids . . . . .
- 4.1.1. The 2-category of 2-braids . . . . .
- 4.1.2. 2-categories of 2-braids up to isotopy . . . . .
- 4.2. Temperley-Lieb 2-categories and Markov trace functors . . . . .
- 4.2.1. The Temperley-Lieb 2-category . . . . .
- 4.2.2. The Temperley-Lieb 2-category with respect to a datum for  
        smoothing of 2-braids . . . . .
- 4.2.3. Markov trace functors . . . . .
- 4.3. The Kauffman 2-bracket invariant . . . . .
- 4.3.1. Smoothing functor . . . . .
- 4.3.2. The Kauffman 2-bracket . . . . .

**A. Appendix**

- A.1. Synthetic category theory . . . . .
- A.2. Synthetic cubical 2-category theory . . . . .

---

---

# CHAPTER 1

---

## INTRODUCTION

## 1.1. Overview

The Jones polynomial invariant of knot theory is of deep significance across geometric topology, representation theory, category theory, and surrounding fields. It was originally discovered not directly as a diagrammatic knot invariant, but as an invariant of braids, observed to furthermore be invariant under the Markov moves. In [13], Kauffman gave a beautiful, geometrically flavoured construction of this braid invariant.

First, the braid group  $\mathcal{B}_n$  is mapped into the Temperley-Lieb algebra  $\mathcal{T}_n$  by smoothing the crossings of a braid to a linear combination of diagrammatic tangles. Second,  $\mathcal{T}_n$  is mapped to  $\mathbb{Z}[A, A^{-1}]$ , the ring of Laurent polynomials in one variable, by taking the Markov trace of a diagrammatic tangle, and extending linearly. In this way, up to a normalisation, we obtain an invariant of braids known as the Kauffman bracket polynomial. The Jones polynomial arises as a modification of the Kauffman bracket polynomial which, unlike the latter, is invariant under the Markov moves on braids, and hence gives rise to a knot invariant.

This thesis is the first of a planned series of works by Therese Mardal Hagland, the author, and Richard Williamson, which take a new look at this construction of Kauffman, placing it in a conceptual, category theoretic framework, and then make use of a higher categorical internalisation of this framework to construct an invariant of 2-braids which categorifies the Kauffman bracket, and of 2-knots which categorifies the Jones polynomial. This is in turn part of a broad programme, amongst the various directions of which we seek to understand our categorification of the Jones polynomial to an invariant of 2-knots by means of higher quantum algebra, and to lay the foundations for a theory of virtual 2-braids and a theory of virtual 2-knots.

## 1.2. Synopsis – I

There are two principal parts to this thesis. In Chapter 3, we approach the construction outlined above of the Kauffman bracket polynomial in a purely category theoretic way. There are several novelties in our approach. Firstly, we do not work with the braid groups  $\mathcal{B}_n$  for  $n \geq 0$  individually. Instead, we define in a canonical way, beginning with a very small amount of data, exactly enough to allow us to express the Reidemeister moves, a strict monoidal category **Braids/R-moves** in a canonical way, and view the Kauffman bracket as a strict monoidal functor whose source is **Braids/R-moves**. This can be thought of as defining the Kauffman bracket for all of these braid groups in one go.

In a similar way, we do not work with the Temperley-Lieb algebras  $\mathcal{T}_n$  for  $n \geq 0$  individually, but rather work with them all in one go, by means, given an auxiliary datum  $\mathbb{S}$ , with a canonically constructed strict monoidal category  $\text{TL}(\mathbb{S})$ . We express smoothing of braids, one of the two key aspects of Kauffman's construction, as a strict monoidal functor from **Braids/R-moves** to  $\text{TL}(\mathbb{S})$ . The details of the framework which we put in place to construct  $\text{TL}(\mathbb{S})$  are the second significant novelty of our approach.

In order to capture the smoothing of braids that it is one of the two key ingredients

of Kauffman’s construction, it is however necessary to work with linear combinations of diagrammatic tangles, with coefficients which are polynomials in a pair of variables  $A$  and  $B$ . We do *not* achieve this by means of enrichment of a strict monoidal category over  $\mathbb{Z}[A, B]\text{-Mod}$ , as one might first think. Instead, we define  $\text{TL}(\mathbb{S})$  to be a 2-ring, namely a ring internal to  $\text{Cat}$ , constructed canonically from a very small amount of data, which exactly allows us to express the smoothing of an under crossing and an over crossing, together with the datum  $\mathbb{S}$ .

To explain this, a principal motivation for our category theoretic reworking of the construction of the Kauffman bracket is to put in place a framework that seamlessly can be lifted to a higher categorical setting, allowing us to define a categorified Kauffman bracket for 2-braids. To achieve this, we develop all of the category theoretic machinery that we need to carry out the construction of the Kauffman bracket for braids internally to a sufficiently structured category  $\mathcal{C}$ . In our construction of the Kauffman bracket for braids, we take  $\mathcal{C}$  to be  $\text{Cat}$ , the category of categories. But in our construction of the categorified Kauffman bracket for 2-braids in the second part of this work, we take  $\mathcal{C}$  to be  $2\text{-Cat}$ , the category of cubical 2-categories. In this way, all of our framework categorifies effortlessly.

The notion of a category enriched over  $\mathbb{Z}[A, B]\text{-Mod}$  is not, unlike the rest of our framework, one that can be internalised in a simple manner. It is for this reason that we work instead with 2-rings. It is straightforward to express the notion of a ring internally to a category. The notion of a 2-ring is that which we obtain by internalising to  $\text{Cat}$ . It is the recognition that 2-rings, and in fact also modules over them, although we shall not explicitly make use of the latter in this work, can achieve the same purpose as categories enriched over a category of modules, that we particularly regard as a significant aspect of our approach.

Our treatment of the Markov trace, the second of the two key aspects of Kauffman’s construction, is a third significant novelty of our approach. Various approaches have been taken to capturing notions of trace category theoretically, for instance by Yetter in [18], and by Joyal, Street, and Verity in [10]. This is achieved by requiring, as part of the structure of one’s (monoidal) category, the possibility of manipulating certain maps to obtain others, in a way which obeys a certain prescription. Instead, we construct a Markov trace as a *functor*, constructed in a canonical way, from  $\text{TL}(\mathbb{S})$  to a 2-ring, directly analogous to the way in which the Markov trace of  $\mathcal{T}_n$  can be viewed as a map to a polynomial ring  $\mathbb{Z}[A, B, \gamma]$  in three variables.

Throughout, our canonical definitions of **Braids/R-moves** and  $\text{TL}(\mathbb{S})$  allow us to focus on the essence of Kauffman’s construction when defining the smoothing of braids and the Markov trace, namely how to smooth an over crossing and an under crossing, and how to define the Markov trace of a single generating diagrammatic tangle, which we denote by **CupAndCap**. The rest is taken care of by the universal properties with which **Braids/R-moves** and  $\text{TL}(\mathbb{S})$  are equipped as a consequence of their canonical construction.

Though our focus in Chapter 3 is upon establishing a robust categorical framework for the construction of the Kauffman bracket invariant, our approach highlights certain points regarding the invariant itself that may not be widely appreciated. Firstly, the

invariance of the Kauffman bracket under the R3 moves follows immediately from the cyclicity property of the Markov trace; and, for the same reason, invariance under one of the R2 moves immediately ensures invariance under the other. Thus we obtain an invariant by forcing the Markov trace of the smoothing of one side of one of the R2 moves to be equal to the Markov trace of the smoothing of the other side of this R2 move.

If our Markov trace is to  $\mathbb{Z}[A, B, \gamma]$ , then the Markov trace of the smoothing of one side of the R2 move is

$$A^2\gamma + AB\gamma^2 + B^2\gamma + AB,$$

whilst the Markov trace of the smoothing of the other side is 1. Our second point is that the canonical quotient of  $\mathbb{Z}[A, B, \gamma]$  for which we obtain an invariant is thus

$$\mathbb{Z}[A, B, \gamma] / (A^2\gamma + AB\gamma^2 + B^2\gamma + AB - 1).$$

For this invariant to be useful, it is necessary to be able to decide whether two polynomials in  $A$ ,  $B$ , and  $\gamma$  are equal when passing to

$$\mathbb{Z}[A, B, \gamma] / (A^2\gamma + AB\gamma^2 + B^2\gamma + AB - 1).$$

To establish this, one method is to construct a morphism of rings from

$$\mathbb{Z}[A, B, \gamma] / (A^2\gamma + AB\gamma^2 + B^2\gamma + AB - 1)$$

to a ring in which equality can more easily be decided. One such ring is  $\mathbb{Z}[A, A^{-1}]$ , which admits a morphism from

$$\mathbb{Z}[A, B, \gamma] / (A^2\gamma + AB\gamma^2 + B^2\gamma + AB - 1)$$

given by:

$$\begin{aligned} A &\mapsto A, \\ B &\mapsto A^{-1}, \\ \gamma &\mapsto -A^2 - A^{-2}. \end{aligned}$$

However, other rings can also be used, such as the ring  $\mathbb{Z}[A]/(A^2 - 1)$ , which admits a morphism from

$$\mathbb{Z}[A, B, \gamma] / (A^2\gamma + AB\gamma^2 + B^2\gamma + AB - 1)$$

given by:

$$\begin{aligned} A &\mapsto A, \\ B &\mapsto 0, \\ \gamma &\mapsto 1. \end{aligned}$$

This ring allows us, for instance, to detect the fact that the braid version of the trefoil knot is not isotopic to the trivial braid, namely the braid version of the unknot. In summary, whilst the ring of Laurent polynomials  $\mathbb{Z}[A, A^{-1}]$  is used almost always in the literature as the recipient of the Kauffman bracket, we wish to emphasise that it is *not* the canonical choice of recipient, and only one of several rings which are useful for calculational purposes.

Thirdly, on a more minor note, we do not actually work with rings in the usual sense in this work, but with what are typically known as semirings, without additive inverses. The construction of the Kauffman bracket goes through perfectly well. In our framework, commutativity also appears naturally as a consequence of our construction of the Markov trace. We do not impose it from the beginning, and all aspects of the construction of the Kauffman bracket except for those making use of the cyclicity property of the Markov trace do not require it.

### 1.3. Synopsis – II

In Chapter 4, the second principal part of this work, we categorify the constructions of the first part to obtain an invariant of 2-braids. By design, as already discussed, the framework categorifies effortlessly. However, as with any interesting categorification, this framework alone does not give an invariant.

We make certain choices which our higher categorical framework canonically builds upon to define a 2-category **2-Braids** of 2-braids, a Temperley-Lieb 3-ring  $2\text{-TL}(\mathbb{S})$  given a certain datum  $\mathbb{S}$ , smoothing of 2-braids, and a Markov trace functor for diagrammatic 2-tangles. The 1-categorical truncation of all of these constructions agrees with that of the first part of this work. It is the 2-arrows of **2-Braids** that correspond to a geometric notion of 2-braid, and the 2-arrows of  $2\text{-TL}(\mathbb{S})$  that correspond to linear combinations of a geometric notion of diagrammatic 2-tangle. The choices to which we referred at the beginning of the paragraph determine these 2-arrows, and allow us to express our notion of smoothing of 2-braids. These choices of how to define **2-Braids** and  $2\text{-TL}$ , and how to define smoothing of 2-braids, have been arrived at geometrically, and, though entirely implicit, we regard this work as the heart of the second part of the thesis.

In addition, we make the choice of the category of cubical 2-categories as that in which to internalise the framework of the first part of this work. Just as braids can be built up from over-crossings and under-crossings, we wish to express formally the idea that 2-braids can be built up from those choices of 2-braid which we have just discussed. As a square has two pairs of opposite edges, so a 2-braid has two pairs of opposite braids. This suggests that 2-braids be built up by means of two notions of composition of 2-braids, namely glueing 2-braids together in the direction of one of the two pairs of opposite braids, and glueing 2-braids together in the direction of the other of these pairs. This is naturally captured in a cubical setting for 2-category theory.

The choice of a cubical as opposed to a globular setting for 2-category theory appears to us to be essential. Indeed, in a globular setting, one cannot specify that the source and target braids in one of the two directions of composition be the same, and one is



thus led to admit formal compositions which are nonsensical from a geometrical point of view.

## 1.4. Relationship to other work

The idea to capture knotted surfaces of one kind or another in a higher categorical setting is a natural one. However, the only work we are aware of which touches on ours is that on 2-tangles which we discussed at the beginning of §4.2, which, as we discuss there, is significantly different both in motivation and in technical detail.

We are not aware of any prior work on a geometrically motivated, algebraic definition of a 2-braid group. The only approach to the theory of 2-braids that we are aware of in the literature is that discussed for instance by Kamada in [11]. It differs greatly from ours. We are not aware of any work at all, geometric or algebraic, on smoothing of 2-braids.

An influential algebraic definition of a 2-braid group, approached from an entirely different point of view, was given by Rouquier in [16]. It is not at all clear that 2-braids in the geometric sense are captured by the latter definition. In particular, we do not see that the 2-braid group of [16] could capture those braids which involve triple plane crossings, and in particular the tetrahedral move, which is expected to be related to Zamolodchikov equations, discussed in [12], and expected to be at the heart of an approach via higher quantum algebra to the kind of invariant which we construct in this work.

The construction of a Jones polynomial-like invariant of 2-knots is a very natural problem, and one would expect a good solution to it to have deep ramifications across several fields, just as with the ordinary Jones polynomial. Despite this, a construction of such a gadget, or of a Kauffman bracket-like invariant as a step towards it, having been suggested prior to the recent work [14] of Therese Mardal Hagland. The author has not been directly influenced by [14], and our approach is in several ways considerably different. Nevertheless, [14] has influenced the author's supervisor greatly, and in this way [14] has had an important indirect influence on this thesis.

## 1.5. Future directions

Though the opportunity has not arisen to include it in the thesis, the author and her supervisor believe to understand how build up upon the work of this thesis to construct the Jones polynomial of knots in a categorical framework, and, categorifying this framework, to construct a Jones polynomial-like invariant of 2-knots. This will include a new, algebraic approach to diagrammatic knot theory and diagrammatic 2-knot theory.

In the case of diagrammatic knot theory, this will again involve an internalisation of the categorical framework of the first part of this work to cubical 2-categories, but in an entirely different way to that in the second part of this work. This will allow us to

construct knot diagrams by composing in two directions from certain basic building blocks. We will be able to express R0, R1, R2, and R3 moves in this setting, allowing us to work with knots up to isotopy.

In the case of diagrammatic 2-knot theory, this will involve an internalisation of the categorical framework of the first part of this work to cubical 3-categories, allowing us to construct diagrams of 2-knots by composing in three directions from certain basic building blocks. In addition to double and triple plane crossings as considered in the 2-braid setting, we will be able to work with Whitney umbrella crossings. We will be able to express all seven of the Roseman moves in this setting, allowing us to work with 2-knots up to isotopy.

## **1.6. Preliminaries and foundations**

We refer the reader to the appendix to this work for notation, terminology, and assumptions that we shall, without mention, make use of throughout. We also explain in the appendix the foundational setting in which we work.



---

---

## CHAPTER 2

---

# INTERNAL ALGEBRAIC STRUCTURES AND CERTAIN FREE CONSTRUCTIONS

## 2.1. Internal algebraic structures

In this section, we define, internally to a category  $\mathcal{C}$  which has a final object, the algebraic structures that we make use of in this work: monoids, commutative monoids, and semirings (which we refer to simply as rings). When  $\mathcal{C}$  is the category of sets, we recover the algebraic structures that are usually referred to by these names. In this work, however, we shall in Chapter 3 take  $\mathcal{C}$  to be  $\mathbf{Cat}$ , the category of small categories, and in Chapter 4 take  $\mathcal{C}$  to be  $\mathbf{2-Cat}$ , the category of cubical 2-categories.

We observe that monoids internal to  $\mathcal{C}$  assemble into a category  $\mathbf{Mon}(\mathcal{C})$ , and that rings internal to  $\mathcal{C}$  assemble into a category  $\mathbf{Ring}(\mathcal{C})$ . These categories are constructed canonically, in a 2-categorical setting, in [17], and are demonstrated to admit various categorical constructions, but we do not go into this here, beyond stating the latter.

Finally, we carry out a form of the Eckmann-Hilton argument in two settings. First, we demonstrate that composition coincides with multiplication, and that both are commutative, for arrows

$$1_R \longrightarrow 1_R$$

of a 2-ring  $R$ . Second, we demonstrate that both horizontal and vertical composition coincide with multiplication, and that all three are commutative, for 2-arrows of a 3-ring  $R$  whose boundary is as follows.

$$\begin{array}{ccc} 1_{\mathbb{T}} & \xrightarrow{id} & 1_{\mathbb{T}} \\ id \downarrow & & \downarrow id \\ 1_{\mathbb{T}} & \xrightarrow{id} & 1_{\mathbb{T}} \end{array}$$

### 2.1.1. Monoids

**Assumption 2.1.1.1.** Let  $\mathcal{C}$  be a category, and let  $1_{\mathcal{C}}$  be a final object of  $\mathcal{C}$ .

**Notation 2.1.1.2.** Let  $A$  be an object of  $\mathcal{C}$ . Let

$$A \xleftarrow{p_1^{A,bi}} A \times A \xrightarrow{p_2^{A,bi}} A$$

be a diagram in  $\mathcal{C}$  which defines a binary product. Let

$$1_{\mathcal{C}} \xrightarrow{a} A$$

be an arrow of  $\mathcal{C}$ . Let

$$A \xrightarrow{p} 1$$

be the canonical arrow to which the universal property of  $1_C$  gives rise. We denote by

$$A \xrightarrow{a \times id} A \times A$$

the canonical arrow of  $\mathcal{C}$  such that the following diagram in  $\mathcal{C}$  commutes.

$$\begin{array}{ccccc}
 & & A & & \\
 & \swarrow & \downarrow & \searrow & \\
 & a \circ p & a \times id & id & \\
 A & \xleftarrow{p_1^{A,bi}} & A \times A & \xrightarrow{p_2^{A,bi}} & A
 \end{array}$$

We denote by

$$A \xrightarrow{id \times a} A \times A$$

the canonical arrow of  $\mathcal{C}$  such that the following diagram in  $\mathcal{C}$  commutes.

$$\begin{array}{ccccc}
 & & A & & \\
 & \swarrow & \downarrow & \searrow & \\
 & id & id \times a & a \circ p & \\
 A & \xleftarrow{p_1^{A,bi}} & A \times A & \xrightarrow{p_2^{A,bi}} & A
 \end{array}$$

**Definition 2.1.1.3.** A *monoid internal to  $\mathcal{C}$*  consists of the following data.

- (1) An object  $M$  of  $\mathcal{C}$ .
- (2) A diagram

$$M \xleftarrow{p_1^{M,bi}} M \times M \xrightarrow{p_2^{M,bi}} M$$

in  $\mathcal{C}$  which defines a binary product.

- (3) A diagram

$$\begin{array}{ccccc}
 & & M \times M \times M & & \\
 & \swarrow & \downarrow & \searrow & \\
 & p_1^{M,tri} & p_2^{M,tri} & p_3^{M,tri} & \\
 M & & M & & M
 \end{array}$$

in  $\mathcal{C}$  which defines a triple product.

(4) An arrow

$$M \times M \xrightarrow{\cdot} M$$

of  $\mathcal{C}$ .

(5) An arrow

$$1_{\mathcal{C}} \xrightarrow{1} M$$

of  $\mathcal{C}$ .

We require that the following hold.

(1) The following diagram in  $\mathcal{C}$  commutes.

$$\begin{array}{ccc} M \times M \times M & \xrightarrow{\cdot \times id} & M \times M \\ id \times \cdot \downarrow & & \downarrow \cdot \\ M \times M & \xrightarrow{\cdot} & M \end{array}$$

(2) The following diagram in  $\mathcal{C}$  commutes.

$$\begin{array}{ccc} M & \xrightarrow{1 \times id} & M \times M \\ & \searrow id & \downarrow \cdot \\ & & M \end{array}$$

(3) The following diagram in  $\mathcal{C}$  commutes.

$$\begin{array}{ccc} M & \xrightarrow{id \times 1} & M \times M \\ & \searrow id & \downarrow \cdot \\ & & M \end{array}$$

**Terminology 2.1.1.4.** We refer to a monoid internal to  $\mathbf{Cat}$  as a *strict monoidal category*.

**Remark 2.1.1.5.** We might have instead referred to a monoid internal to  $\mathbf{Cat}$  as a *2-monoid*, and to a monoid internal to  $2\text{-Cat}$  as a *3-monoid*, to be consistent with the terminology we shall adopt in §2.1.3 to refer to a ring internal to  $\mathbf{Cat}$  or  $2\text{-Cat}$ , but, to avoid possible obfuscation, we shall not do so.

**Terminology 2.1.1.6.** We refer to a monoid internal to  $2\text{-Cat}$  as a *strict monoidal cubical 2-category*.

**Notation 2.1.1.7.** When working with monoids internal to  $\mathbf{Cat}$  or to  $2\text{-Cat}$ , namely with strict monoidal categories or with strict monoidal cubical 2-categories, we shall typically denote the functor  $\cdot$  by  $\otimes$ .

**Definition 2.1.1.8.** Let  $\mathbf{M}_0$  and  $\mathbf{M}_1$  be monoids internal to  $\mathcal{C}$ . Let us denote by  $M_0$  the object of  $\mathcal{C}$  which is part of the data of  $\mathbf{M}_0$ , and denote the remaining pieces of data of  $\mathbf{M}_0$  as follows.

$$\begin{array}{c}
 M_0 \xleftarrow{p_1^{M_0, bi}} M_0 \times M_0 \xrightarrow{p_2^{M_0, bi}} M_0 \\
 \\
 \begin{array}{ccc}
 & M_0 \times M_0 \times M_0 & \\
 p_1^{M_0, tri} \swarrow & \downarrow p_2^{M_0, tri} & \searrow p_3^{M_0, tri} \\
 M_0 & M_0 & M_0
 \end{array} \\
 \\
 M_0 \times M_0 \xrightarrow{\cdot^{M_0}} M_0 \\
 \\
 1_{\mathcal{C}} \xrightarrow{1_{M_0}} M_0
 \end{array}$$

Let us denote by  $M_1$  the object of  $\mathcal{C}$  which is part of the data of  $\mathbf{M}_1$ , and denote the remaining pieces of data of  $\mathbf{M}_1$  as follows.

$$\begin{array}{c}
 M_1 \xleftarrow{p_1^{M_1, bi}} M_1 \times M_1 \xrightarrow{p_2^{M_1, bi}} M_1 \\
 \\
 \begin{array}{ccc}
 & M_1 \times M_1 \times M_1 & \\
 p_1^{M_1, tri} \swarrow & \downarrow p_2^{M_1, tri} & \searrow p_3^{M_1, tri} \\
 M_1 & M_1 & M_1
 \end{array}
 \end{array}$$



$$M_1 \times M_1 \xrightarrow{\cdot_{M_1}} M_1$$

$$1_{\mathcal{C}} \xrightarrow{1_{M_1}} M_1$$

A *morphism* from  $\mathbf{M}_0$  to  $\mathbf{M}_1$  consists of an arrow

$$M_0 \xrightarrow{F} M_1$$

of  $\mathcal{C}$  such that the following hold.

- (1) The following diagram in  $\mathcal{C}$  commutes.

$$\begin{array}{ccc} M_0 \times M_0 & \xrightarrow{\cdot_{M_0}} & M_0 \\ F \times F \downarrow & & \downarrow F \\ M_1 \times M_1 & \xrightarrow{\cdot_{M_1}} & M_1 \end{array}$$

- (2) The following diagram in  $\mathcal{C}$  commutes.

$$\begin{array}{ccc} 1_{\mathcal{C}} & \xrightarrow{1_{M_0}} & M_0 \\ & \searrow 1_{M_1} & \downarrow F \\ & & M_1 \end{array}$$

**Terminology 2.1.1.9.** We refer to a morphism of monoids internal to  $\mathbf{Cat}$  or  $\mathbf{2-Cat}$  as a *strict monoidal functor*.

**Remark 2.1.1.10.** Let  $\mathbf{M}_0$ ,  $\mathbf{M}_1$ , and  $\mathbf{M}_2$  be monoids internal to  $\mathcal{C}$ . Let  $M_0$  be the object of  $\mathcal{C}$  which is part of the data of  $\mathbf{M}_0$ , let  $M_1$  be the object of  $\mathcal{C}$  which is part of the data of  $\mathbf{M}_1$ , and let  $M_2$  be the object of  $\mathcal{C}$  which is part of the data of  $\mathbf{M}_2$ . Let

$$M_0 \xrightarrow{F_0} M_1$$

be an arrow of  $\mathcal{C}$  which defines a morphism from  $\mathbf{M}_0$  to  $\mathbf{M}_1$ , and let

$$M_1 \xrightarrow{F_1} M_2$$

be an arrow of  $\mathcal{C}$  which defines a morphism from  $\mathbf{M}_1$  to  $\mathbf{M}_2$ . Then the arrow

$$M_0 \xrightarrow{F_1 \circ F_0} M_2$$

of  $\mathcal{C}$  defines a morphism from  $M_0$  to  $M_2$ .

**Remark 2.1.1.11.** Let  $M$  be a monoid internal to  $\mathcal{C}$ . Let us denote the object of  $\mathcal{C}$  which is part of the data of  $M$  by  $M$ . Then the arrow

$$M \xrightarrow{id} M$$

of  $\mathcal{C}$  defines a morphism from  $M$  to  $M$ .

**Notation 2.1.1.12.** Monoids internal to  $\mathcal{C}$  and morphisms between them assemble, with composition defined as in Remark 2.1.1.10, and identity morphisms defined as in Remark 2.1.1.11, into a category. We shall denote this category by  $\text{Mon}(\mathcal{C})$ .

**Fact 2.1.1.13.** *Suppose that  $\mathcal{C}$  satisfies certain hypotheses given in [17]. Then  $\text{Mon}(\mathcal{C})$  has finite coproducts, coequalisers, pushouts, and binary products.*

**Remark 2.1.1.14.** Fact 2.1.1.13 is proven in [17], and we shall assume it. In [17], the category  $\text{Mon}(\mathcal{C})$  is constructed in a purely 2-categorical way. The demonstration that  $\text{Mon}(\mathcal{C})$  admits the categorical constructions listed in Fact 2.1.1.13 makes use of this 2-categorical point of view.

## 2.1.2. Commutative monoids

**Notation 2.1.2.1.** Let  $M$  be an object of  $\mathcal{C}$ , and let

$$M \xleftarrow{p_1^{M,bi}} M \times M \xrightarrow{p_2^{M,bi}} M$$

be a diagram in  $\mathcal{C}$  which defines a binary product. We denote by

$$M \times M \xrightarrow{\tau} M \times M$$

the canonical arrow of  $\mathcal{C}$  such that the following diagram in  $\mathcal{C}$  commutes.

$$\begin{array}{ccccc}
 & & M \times M & & \\
 & p_2^{M,bi} \swarrow & \downarrow \tau & \searrow p_1^{M,bi} & \\
 M & \xleftarrow{p_1^{M,bi}} & M \times M & \xrightarrow{p_2^{M,bi}} & M
 \end{array}$$

**Definition 2.1.2.2.** Let  $\mathbf{M}$  be a monoid internal to  $\mathcal{C}$ . Let us denote by  $M$  the object of  $\mathcal{C}$  which is part of the data of  $\mathbf{M}$ , and denote the remaining pieces of data of  $\mathbf{M}$  as follows.

$$\begin{array}{c}
 M \xleftarrow{p_1^{M,bi}} M \times M \xrightarrow{p_2^{M,bi}} M \\
 \\
 \begin{array}{ccc}
 & M \times M \times M & \\
 p_1^{M,tri} \swarrow & \downarrow p_2^{M,tri} & \searrow p_3^{M,tri} \\
 M & M & M
 \end{array} \\
 \\
 M \times M \xrightarrow{\cdot^M} M \\
 \\
 1_{\mathcal{C}} \xrightarrow{1_M} M
 \end{array}$$

Then  $\mathbf{M}$  is *commutative* if the following diagram in  $\mathcal{C}$  commutes.

$$\begin{array}{ccc}
 M \times M & \xrightarrow{\tau} & M \times M \\
 & \searrow & \downarrow \cdot \\
 & & M
 \end{array}$$

**Terminology 2.1.2.3.** We refer to a commutative monoid internal to  $\mathbf{Cat}$  as a *strict symmetric monoidal category*.

**Terminology 2.1.2.4.** We refer to a commutative monoid internal to  $2\text{-Cat}$  as a *strict symmetric monoidal cubical 2-category*.

**Remark 2.1.2.5.** We might have instead referred to a commutative monoid internal to  $\mathbf{Cat}$  as a *commutative 2-monoid*, and to a commutative monoid internal to  $2\text{-Cat}$  as a *commutative 3-monoid*, to be consistent with the terminology we shall adopt in §2.1.3 to refer to a ring internal to  $\mathbf{Cat}$  or  $2\text{-Cat}$ , but, to avoid possible obfuscation, we shall not do so.

**Notation 2.1.2.6.** When working with commutative monoids internal to  $\mathcal{C}$ , we shall typically denote  $\cdot$  by  $+$ , and denote  $1$  by  $0$ .

**Notation 2.1.2.7.** When working with commutative monoids internal to  $\mathbf{Cat}$  or  $2\text{-Cat}$ , namely with strict symmetric monoidal categories, we shall typically denote the functor  $\cdot$  by  $\oplus$ .

**Definition 2.1.2.8.** Let  $M_0$  and  $M_1$  be commutative monoids internal to  $\mathcal{C}$ . Let us denote the object of  $\mathcal{C}$  which is part of the data of  $M_0$  by  $M_0$ , and denote the object of  $\mathcal{C}$  which is part of the data of  $M_1$  by  $M_1$ . A *morphism* from  $M_0$  to  $M_1$  is an arrow

$$M_0 \xrightarrow{F} M_1$$

of  $\mathcal{C}$  which defines a morphism from  $M_0$  to  $M_1$ .

### 2.1.3. Rings

**Notation 2.1.3.1.** Let  $R$  be an object of  $\mathcal{C}$ . Let

$$R \xleftarrow{p_1^{R,bi}} R \times R \xrightarrow{p_2^{R,bi}} R$$

be a diagram in  $\mathcal{C}$  which defines a binary product. We denote by

$$R \xrightarrow{\Delta} R \times R$$

the canonical arrow of  $\mathcal{C}$  such that the following diagram in  $\mathcal{C}$  commutes.

$$\begin{array}{ccccc} & & R & & \\ & id \swarrow & \downarrow \Delta & \searrow id & \\ R & \xleftarrow{p_1^{R,bi}} & R \times R & \xrightarrow{p_2^{R,bi}} & R \end{array}$$

**Definition 2.1.3.2.** A *ring internal to  $\mathcal{C}$*  consists of the following data.

- (1) An object  $R$  of  $\mathcal{C}$ .
- (2) A diagram

$$R \xleftarrow{p_1^{R,bi}} R \times R \xrightarrow{p_2^{R,bi}} R$$

in  $\mathcal{C}$  which defines a binary product.

- (3) A diagram

$$\begin{array}{ccccc} & & R \times R \times R & & \\ & p_1^{R,tri} \swarrow & \downarrow p_2^{R,tri} & \searrow p_3^{R,tri} & \\ R & & R & & R \end{array}$$

in  $\mathcal{C}$  which defines a triple product.

(4) An arrow

$$R \times R \xrightarrow{+} R$$

of  $\mathcal{C}$ .

(5) An arrow

$$1_{\mathcal{C}} \xrightarrow{0} R$$

of  $\mathcal{C}$ .

(6) An arrow

$$R \times R \xrightarrow{\cdot} R$$

of  $\mathcal{C}$ .

(7) An arrow

$$1_{\mathcal{C}} \xrightarrow{1} R$$

of  $\mathcal{C}$ .

We require that the following hold.

- (1) The data of (1) – (5) defines a commutative monoid internal to  $\mathcal{C}$ .
- (2) The data of (1) – (3) and (6) – (7) defines a monoid internal to  $\mathcal{C}$ .
- (3) The following diagram in  $\mathcal{C}$  commutes.

$$\begin{array}{ccc}
R \times R \times R & \xrightarrow{\Delta \times id \times id} & R \times R \times R \times R \\
\downarrow id \times + & & \downarrow id \times \tau \times id \\
& & R \times R \times R \times R \\
& & \downarrow \cdot \times \cdot \\
& & R \times R \\
& & \downarrow + \\
R \times R & \xrightarrow{\quad \cdot \quad} & R
\end{array}$$

(4) The following diagram in  $\mathcal{C}$  commutes.

$$\begin{array}{ccc}
R \times R \times R & \xrightarrow{id \times id \times \Delta} & R \times R \times R \times R \\
\downarrow + \times id & & \downarrow id \times \tau \times id \\
& & R \times R \times R \times R \\
& & \downarrow \cdot \times \cdot \\
& & R \times R \\
& & \downarrow + \\
R \times R & \xrightarrow{\quad \cdot \quad} & R
\end{array}$$

**Terminology 2.1.3.3.** We refer to a ring internal to  $\mathbf{Cat}$  as a *2-ring*.

**Terminology 2.1.3.4.** We refer to a ring internal to  $2\text{-Cat}$  as a *3-ring*.

**Terminology 2.1.3.5.** We refer to the commutative monoid defined by the data of (1) – (5) in Definition 2.1.3.2 as the *additive structure* of a ring internal to  $\mathcal{C}$ .

**Notation 2.1.3.6.** Let  $R$  be a ring internal to  $\mathcal{C}$ . We denote its additive structure by  $R^{\text{add}}$ .

**Terminology 2.1.3.7.** We refer to the monoid defined by the data of (1) – (3) and (6) – (7) in Definition 2.1.3.2 as the *multiplicative structure* of a ring internal to  $\mathcal{C}$ .

**Notation 2.1.3.8.** Let  $R$  be a ring internal to  $\mathcal{C}$ . We denote its multiplicative structure by  $R^{\text{mult}}$ .

**Remark 2.1.3.9.** When  $\mathcal{C}$  is the category of sets, a ring internal to  $\mathcal{C}$  is usually referred to as a *commutative semiring* or *commutative rig*. In particular, we do not require the monoid which defines the additive structure of a ring to have inverses.

**Definition 2.1.3.10.** Let  $\mathbf{R}_0$  and  $\mathbf{R}_1$  be rings internal to  $\mathcal{C}$ . Let  $R_0$  be the object of  $\mathcal{C}$  which is part of the data of  $\mathbf{R}_0$ , and let  $R_1$  be the object of  $\mathcal{C}$  which is part of the data of  $\mathbf{R}_1$ . A *morphism* from  $\mathbf{R}_0$  to  $\mathbf{R}_1$  consists of an arrow

$$R_0 \xrightarrow{F} R_1$$

of  $\mathcal{C}$  such that the following hold.

- (1) The arrow  $F$  defines a morphism from  $\mathbf{R}_0^{\text{add}}$  to  $\mathbf{R}_1^{\text{add}}$ .
- (2) The arrow  $F$  defines a morphism from  $\mathbf{R}_0^{\text{mult}}$  to  $\mathbf{R}_1^{\text{mult}}$ .

**Terminology 2.1.3.11.** We refer to a morphism of rings internal to  $\mathbf{Cat}$  as a *functor of 2-rings*.

**Terminology 2.1.3.12.** We refer to a morphism of rings internal to  $2\text{-Cat}$  as a *functor of 3-rings*.

**Remark 2.1.3.13.** Let  $\mathbf{R}_0$ ,  $\mathbf{R}_1$ , and  $\mathbf{R}_2$  be rings internal to  $\mathcal{C}$ . Let  $R_0$  be the object of  $\mathcal{C}$  which is part of the data of  $\mathbf{R}_0$ , let  $R_1$  be the object of  $\mathcal{C}$  which is part of the data of  $\mathbf{R}_1$ , and let  $R_2$  be the object of  $\mathcal{C}$  which is part of the data of  $\mathbf{R}_2$ . Let

$$R_0 \xrightarrow{F_0} R_1$$

be an arrow of  $\mathcal{C}$  which defines a morphism from  $\mathbf{R}_0$  to  $\mathbf{R}_1$ , and let

$$R_1 \xrightarrow{F_1} R_2$$

be an arrow of  $\mathcal{C}$  which defines a morphism from  $\mathbf{R}_1$  to  $\mathbf{R}_2$ . Then the arrow

$$R_0 \xrightarrow{F_1 \circ F_0} R_2$$

of  $\mathcal{C}$  defines a morphism of from  $\mathbf{R}_0$  to  $\mathbf{R}_2$ .

**Remark 2.1.3.14.** Let  $\mathbf{R}$  be a ring internal to  $\mathcal{C}$ . Let  $R$  be the object of  $\mathcal{C}$  which is part of the data of  $\mathbf{R}$ . Then the arrow

$$R \xrightarrow{id} R$$

of  $\mathcal{C}$  defines a morphism from  $\mathbf{R}$  to  $\mathbf{R}$ .

**Notation 2.1.3.15.** Rings internal to  $\mathcal{C}$  and morphisms between them assemble, with composition defined as in Remark 2.1.3.13, and identity morphisms defined as in Remark 2.1.3.14, into a category. We shall denote this category by  $\mathbf{Ring}(\mathcal{C})$ .

**Fact 2.1.3.16.** *Suppose that  $\mathcal{C}$  satisfies certain hypotheses given in [17]. Then  $\mathbf{Ring}(\mathcal{C})$  has finite coproducts, coequalisers, pushouts, and binary products.*

**Remark 2.1.3.17.** Fact 2.1.3.16 is proven in [17], and we shall assume it. As discussed in Remark 2.1.1.14 for  $\mathbf{Mon}(\mathcal{C})$ , the category  $\mathbf{Ring}(\mathcal{C})$  is constructed in a purely 2-categorical way in [17], and the demonstration that  $\mathbf{Ring}(\mathcal{C})$  admits the categorical constructions listed in Fact 2.1.3.16 makes use of this 2-categorical point of view.

**Remark 2.1.3.18.** Crucial to our categorical construction of the Kauffman bracket for braids will be to, roughly speaking, equip the arrows of a monoidal category with the structure of a free (left)  $\mathbf{R}$ -module, where  $\mathbf{R}$  is a ring internal to the category of sets. Typically, one would make use of the notion of a monoidal category enriched over the category of  $\mathbf{R}$ -modules to express this idea. However, the definition of an enriched category is not one which is simple to express internally to a category. As discussed in the introduction to this work, internalisation is a fundamental to the approach which we shall take in Chapter 4 to categorifying the framework for constructing the Kauffman bracket which we shall establish in Chapter 3.

The notion of a module over a ring is one which is straightforward to express internally to a category  $\mathcal{C}$ . Whilst we omit a formal definition, because we shall not make use of it elsewhere, let us refer in this remark to a module internal to  $\mathbf{Cat}$  over a 2-ring as a *2-module* over this 2-ring. Let  $\mathbf{R}$  be a ring internal to the category of sets. As we shall now explain, a category enriched over the category of (left)  $\mathbf{R}$ -modules can be viewed as a 2-module over the discrete 2-ring determined by  $\mathbf{R}$ . We give this explanation in the language of category theory in a set-theoretic foundations, rather than in the setting, described in the appendix, in which we are carrying out our formal work,

Given any set  $X$ , let us denote the discrete category determined by  $X$  by  $\mathbf{disc}(X)$ . This category can be defined as follows.

- (1) The set of objects  $\mathbf{Ob}(\mathbf{disc}(X))$  is  $X$ .
- (2) The set of arrows  $\mathbf{Arr}(\mathbf{disc}(X))$  is  $X$ .
- (3) The source and target maps

$$\mathbf{Arr}(\mathbf{disc}(X)) \longrightarrow \mathbf{Ob}(\mathbf{disc}(X))$$

are both the identity map

$$X \xrightarrow{id} X.$$



(4) The map

$$\text{Ob}(\text{disc}(X)) \longrightarrow \text{Arr}(\text{disc}(X))$$

of  $\text{disc}(X)$  defining the identity arrows of  $\text{disc}(X)$  is the identity map

$$X \xrightarrow{id} X.$$

(5) The map

$$\text{Arr}(\text{disc}(X)) \times_{\text{Ob}(\text{disc}(X))} \text{Arr}(\text{disc}(X)) \longrightarrow \text{Arr}(\text{disc}(X))$$

defining composition of arrows of  $\text{disc}(X)$  is, observing that the diagram

$$\begin{array}{ccc} X & \xrightarrow{id} & X \\ id \downarrow & & \downarrow id \\ X & \xrightarrow{id} & X \end{array}$$

defines a pullback in the category of sets, is the identity map

$$X \xrightarrow{id} X.$$

Let  $R$  be the set which is part of the data of  $\mathbf{R}$ . We equip  $\text{disc}(R)$  with the structure of a 2-ring  $\text{disc}(\mathbf{R})$  in the following way.

(1) The functor

$$\text{disc}(R) \times \text{disc}(R) \xrightarrow{\oplus} \text{disc}(R)$$

is given both on objects and on arrows by the map

$$R \times R \xrightarrow{+} R.$$

(2) Viewing  $1_{\text{Cat}}$  as  $\text{disc}(1_{\text{Set}})$ , where  $1_{\text{Set}}$  is a final object of the category of sets, the functor

$$1_{\text{Cat}} \xrightarrow{0} \text{disc}(R)$$

is given both on objects and on arrows by the map

$$1_{\text{Set}} \xrightarrow{0} R.$$

(3) The functor

$$\text{disc}(R) \times \text{disc}(R) \xrightarrow{\otimes} \text{disc}(R)$$

is given on both objects and on arrows by the map

$$R \times R \xrightarrow{\cdot} R.$$

(4) Viewing  $1_{\text{Cat}}$  in the same way as in (2), the functor

$$1_{\text{Cat}} \xrightarrow{1} \text{disc}(R)$$

is given both on objects and on arrows by the map

$$1_{\text{Set}} \xrightarrow{1} R.$$

Let us refer to the 2-ring  $\text{disc}(R)$  as the *discrete 2-ring* on  $R$ .

A category enriched over the category of modules over  $R$  is exactly the data of a 2-module  $M$  over  $\text{disc}(R)$  with the property that, letting  $\mathcal{M}$  denote the category which is part of the data of  $M$ , the functor

$$\text{disc}(R) \times \mathcal{M} \longrightarrow \mathcal{M}$$

which is part of the data of  $M$  is the projection map on objects, namely  $r \otimes_M m = m$  for every element  $r$  of  $R$  and every object  $m$  of  $M$ .

This leads to the idea to work with 2-modules over a 2-ring in internal category theory, rather than with enriched categories. Taking this one step further, it suggests to work with the notion of an algebra over a ring in internal category theory rather than with enriched monoidal categories.

In fact, though, we shall not explicitly make use of the notion of an algebra over a ring internal to a category in this work. Instead, we shall make use of free rings internal to a category, and categorical constructions in  $\mathbf{Ring}(\mathcal{C})$ . In this way, we shall be able to express formally all that we would require of the notion of an algebra over a ring internal to a category.

**Remark 2.1.3.19.** That, as described in Remark 2.1.3.18, 2-modules over a 2-ring generalise categories enriched over the category of modules over a ring, is an observation which we would imagine is folkloric, but we are not aware of any work in which it appears.

**Proposition 2.1.3.20.** *Let  $\mathcal{R}$  be a 2-ring. Let  $\mathcal{R}$  denote the category which is part of the data of  $\mathcal{R}$ . Let*

$$1_{\mathcal{R}} \xrightarrow{f} 1_{\mathcal{R}}$$

and

$$1_{\mathcal{R}} \xrightarrow{g} 1_{\mathcal{R}}$$

be arrows of  $\mathcal{R}$ . Then the arrows  $g \circ f$ ,  $f \circ g$ ,  $f \otimes_{\mathcal{R}} g$ , and  $g \otimes_{\mathcal{R}} f$  of  $\mathcal{R}$  are equal.

*Proof.* Let

$$\mathcal{R} \xleftarrow{p_1^{\mathcal{R},bi}} \mathcal{R} \times \mathcal{R} \xrightarrow{p_2^{\mathcal{R},bi}} \mathcal{R}$$

be the diagram in  $\mathbf{Cat}$  which is part of the data of  $\mathcal{R}$ , and which defines a binary product. Let

$$\mathcal{I}_0 \sqcup_1 \mathcal{I} \xrightarrow{u} \mathcal{R} \times \mathcal{R}$$

denote the canonical functor such that the following diagram in  $\mathbf{Cat}$  commutes.

$$\begin{array}{ccc}
 1_{\mathbf{Cat}} & \xrightarrow{0} & \mathcal{I} \\
 \downarrow 1 & & \downarrow r_0^{\mathcal{I}_0 \sqcup_1 \mathcal{I}} \\
 \mathcal{I} & \xrightarrow{r_1^{\mathcal{I}_0 \sqcup_1 \mathcal{I}}} & \mathcal{I}_0 \sqcup_1 \mathcal{I} \\
 \downarrow f \times id(1_{\mathcal{R}}) & & \downarrow u \\
 & & \mathcal{R} \times \mathcal{R}
 \end{array}
 \quad
 \begin{array}{l}
 \text{curved arrow } id(1_{\mathcal{R}}) \times g \text{ from } \mathcal{I} \text{ to } \mathcal{R} \times \mathcal{R} \\
 \text{curved arrow } f \times id(1_{\mathcal{R}}) \text{ from } \mathcal{I} \text{ to } \mathcal{R} \times \mathcal{R}
 \end{array}$$

We make the following observations.

(1) By definition of the arrow

$$\mathcal{I} \xrightarrow{(id(1_{\mathcal{R}}) \times g) \circ (f \times id(1_{\mathcal{R}}))} \mathcal{R} \times \mathcal{R},$$

of  $\mathcal{R}$ , the following diagram in  $\mathbf{Cat}$  commutes.

$$\begin{array}{ccc} \mathcal{I} & \xrightarrow{s} & \mathcal{I} \sqcup_0 \mathcal{I} \\ & \searrow & \downarrow u \\ (id(1_{\mathcal{R}}) \times g) \circ (f \times id(1_{\mathcal{R}})) & & \mathcal{R} \times \mathcal{R} \end{array}$$

(2) By definition of the arrow

$$\mathcal{I} \xrightarrow{f \times id(1_{\mathcal{R}})} \mathcal{R} \times \mathcal{R},$$

of  $\mathcal{R}$ , the following diagram in  $\mathbf{Cat}$  commutes.

$$\begin{array}{ccc} \mathcal{I} & \xrightarrow{f \times id(1_{\mathcal{R}})} & \mathcal{R} \times \mathcal{R} \\ & \searrow f & \downarrow p_1^{\mathcal{R}, bi} \\ & & \mathcal{R} \end{array}$$

(3) By definition of the arrow

$$\mathcal{I} \xrightarrow{id(1_{\mathcal{R}}) \times g} \mathcal{R} \times \mathcal{R},$$

of  $\mathcal{R}$ , the following diagram in  $\mathbf{Cat}$  commutes.

$$\begin{array}{ccc} \mathcal{I} & \xrightarrow{id(1_{\mathcal{R}}) \times g} & \mathcal{R} \times \mathcal{R} \\ & \searrow id(1_{\mathcal{R}}) & \downarrow p_1^{\mathcal{R}, bi} \\ & & \mathcal{R} \end{array}$$

(4) We deduce from (1) – (3) that the following diagram in  $\mathbf{Cat}$  commutes.

$$\begin{array}{ccc}
 1_{\mathbf{Cat}} & \xrightarrow{0} & \mathcal{I} \\
 \downarrow 1 & & \downarrow r_0^{\mathcal{I}_0 \sqcup_1 \mathcal{I}} \\
 \mathcal{I} & \xrightarrow{r_1^{\mathcal{I}_0 \sqcup_1 \mathcal{I}}} & \mathcal{I}_0 \sqcup_1 \mathcal{I} \\
 & \searrow p_1^{\mathcal{R}, bi} \circ u & \downarrow \\
 & & \mathcal{R}
 \end{array}
 \begin{array}{l}
 \text{curved arrow } id(1_{\mathcal{R}}) \text{ from } \mathcal{I} \text{ to } \mathcal{R} \\
 \text{curved arrow } f \text{ from } \mathcal{I} \text{ to } \mathcal{R}
 \end{array}$$

(5) Appealing to the universal property of  $\mathcal{I}_0 \sqcup_1 \mathcal{I}$ , and the definition of the arrow  $id(1_{\mathcal{R}}) \circ f$ , we deduce from (4) that the following diagram in  $\mathbf{Cat}$  commutes.

$$\begin{array}{ccc}
 \mathcal{I} & \xrightarrow{(id(1_{\mathcal{R}}) \times g) \circ (f \times id(1_{\mathcal{R}}))} & \mathcal{R} \times \mathcal{R} \\
 \searrow id(1_{\mathcal{R}}) \circ f & & \downarrow p_1^{\mathcal{R}, bi} \\
 & & \mathcal{R}
 \end{array}$$

(6) Since the arrow  $id(1_{\mathcal{R}}) \circ f$  is equal to  $f$ , we deduce from (5) that the following diagram in  $\mathbf{Cat}$  commutes.

$$\begin{array}{ccc}
 \mathcal{I} & \xrightarrow{(id(1_{\mathcal{R}}) \times g) \circ (f \times id(1_{\mathcal{R}}))} & \mathcal{R} \times \mathcal{R} \\
 \searrow f & & \downarrow p_1^{\mathcal{R}, bi} \\
 & & \mathcal{R}
 \end{array}$$

(7) By an entirely analogous argument to that of (1) – (6), the following diagram in  $\mathbf{Cat}$  commutes.

$$\begin{array}{ccc}
 \mathcal{I} & \xrightarrow{(id(1_{\mathcal{R}}) \times g) \circ (f \times id(1_{\mathcal{R}}))} & \mathcal{R} \times \mathcal{R} \\
 \searrow g & & \downarrow p_2^{\mathcal{R}, bi} \\
 & & \mathcal{R}
 \end{array}$$

(8) We deduce from (6), (7), the definition of the arrow

$$\mathcal{I} \xrightarrow{f \times g} \mathcal{R} \times \mathcal{R},$$

of  $\mathcal{R}$ , and the universal property of  $\mathcal{R} \times \mathcal{R}$ , that the arrow

$$(id(1_{\mathcal{R}}) \times g) \circ (f \times id(1_{\mathcal{R}}))$$

of  $\mathcal{R}$  is equal to the arrow  $f \times g$  of  $\mathcal{R}$ .

(9) We deduce from (8) that the following diagram in  $\text{Cat}$  commutes.

$$\begin{array}{ccc} \mathcal{I} & \xrightarrow{(id(1_{\mathcal{R}}) \times g) \circ (f \times id(1_{\mathcal{R}}))} & \mathcal{R} \times \mathcal{R} \\ f \times g \downarrow & & \downarrow \otimes_{\mathcal{R}} \\ \mathcal{R} \times \mathcal{R} & \xrightarrow{\otimes_{\mathcal{R}}} & \mathcal{R} \end{array}$$

(10) Since  $\otimes_{\mathcal{R}}$  is a functor, we deduce from (9) that the arrow

$$(id(1_{\mathcal{R}}) \otimes_{\mathcal{R}} g) \circ (f \otimes_{\mathcal{R}} id(1_{\mathcal{R}}))$$

of  $\mathcal{R}$  is equal to the arrow  $f \otimes_{\mathcal{R}} g$  of  $\mathcal{R}$ .

(11) By requirement (2) of Definition 2.1.1.3 with respect to  $\mathbf{R}^{\text{mult}}$ , the arrow  $id(1_{\mathcal{R}}) \otimes_{\mathcal{R}} g$  of  $\mathcal{R}$  is equal to the arrow  $g$  of  $\mathcal{R}$ .

(12) By requirement (3) of Definition 2.1.1.3 with respect to  $\mathbf{R}^{\text{mult}}$ , the arrow  $f \otimes_{\mathcal{R}} id(1_{\mathcal{R}})$  of  $\mathcal{R}$  is equal to the arrow  $f$  of  $\mathcal{R}$ .

(13) We deduce from (10) – (12) that the arrow  $g \circ f$  of  $\mathcal{R}$  is equal to the arrow  $f \otimes_{\mathcal{R}} g$  of  $\mathcal{R}$ .

Working with the arrow

$$\mathcal{I} \xrightarrow{(g \times id(1_{\mathcal{R}})) \circ (id(1_{\mathcal{R}}) \times f)} \mathcal{R} \times \mathcal{R}$$

of  $\mathcal{R}$  instead of the arrow

$$\mathcal{I} \xrightarrow{(id(1_{\mathcal{R}}) \times g) \circ (f \times id(1_{\mathcal{R}}))} \mathcal{R} \times \mathcal{R},$$

of  $\mathcal{R}$ , an entirely analogous argument demonstrates that the arrow  $g \circ f$  of  $\mathcal{R}$  is also equal to the arrow  $g \otimes_{\mathcal{R}} f$  of  $\mathcal{R}$ . Finally, working with the arrow

$$\mathcal{I} \xrightarrow{(f \times id(1_{\mathcal{R}})) \circ (id(1_{\mathcal{R}}) \times g)} \mathcal{R} \times \mathcal{R}$$

of  $\mathcal{R}$  instead of the arrow

$$\mathcal{I} \xrightarrow{(id(1_{\mathcal{R}}) \times g) \circ (f \times id(1_{\mathcal{R}}))} \mathcal{R} \times \mathcal{R},$$

of  $\mathcal{R}$ , an entirely analogous argument demonstrates that the arrow  $f \circ g$  of  $\mathcal{R}$  is equal to the arrow  $f \otimes_{\mathcal{R}} g$  of  $\mathcal{R}$ . Putting all of this together, we have that

$$g \otimes_{\mathcal{R}} f = g \circ f = f \otimes_{\mathcal{R}} g = f \circ g.$$

□

**Proposition 2.1.3.21.** *Let  $\mathcal{R}$  be a 3-ring. Let  $\mathcal{R}$  denote the cubical 2-category which is part of the data of  $\mathcal{R}$ . Let*

$$\begin{array}{ccc} 1_{\mathcal{R}} & \xrightarrow{id} & 1_{\mathcal{R}} \\ id \downarrow & \sigma & \downarrow id \\ 1_{\mathcal{R}} & \xrightarrow{id} & 1_{\mathcal{R}} \end{array}$$

and

$$\begin{array}{ccc} 1_{\mathcal{R}} & \xrightarrow{id} & 1_{\mathcal{R}} \\ id \downarrow & \tau & \downarrow id \\ 1_{\mathcal{R}} & \xrightarrow{id} & 1_{\mathcal{R}} \end{array}$$

be 2-arrows of  $\mathcal{R}$ . Then the 2-arrows  $\tau \circ_{ver} \sigma$ ,  $\sigma \circ_{ver} \tau$ ,  $\tau \circ_{hor} \sigma$ ,  $\sigma \circ_{hor} \tau$ ,  $\sigma \otimes_{\mathcal{R}} \tau$ , and  $\tau \otimes_{\mathcal{R}} \sigma$  of  $\mathcal{R}$  are equal.

*Proof.* Let

$$\mathcal{R} \xleftarrow{p_1^{\mathcal{R},bi}} \mathcal{R} \times \mathcal{R} \xrightarrow{p_2^{\mathcal{R},bi}} \mathcal{R}$$

be the diagram in 2-Cat which is part of the data of  $\mathcal{R}$ , and which defines a binary product. Let

$$\mathcal{S}_n \sqcup_s \mathcal{S} \xrightarrow{u} \mathcal{R} \times \mathcal{R}$$

denote the canonical functor such that the following diagram in 2-Cat commutes.

$$\begin{array}{ccc}
 \mathcal{I} & \xrightarrow{\mathbf{n}} & \mathcal{S} \\
 \downarrow \mathbf{s} & & \downarrow r_0^{\mathcal{S}_n \sqcup_s \mathcal{S}} \\
 \mathcal{S} & \xrightarrow{r_1^{\mathcal{S}_n \sqcup_s \mathcal{S}}} & \mathcal{S}_n \sqcup_s \mathcal{S} \\
 \downarrow \sigma \times id_{ver}(id(1_{\mathcal{R}})) & & \downarrow u \\
 & & \mathcal{R} \times \mathcal{R}
 \end{array}
 \quad \begin{array}{l}
 \text{curved arrow from } \mathcal{I} \text{ to } \mathcal{R} \times \mathcal{R}: id_{ver}(id(1_{\mathcal{R}})) \times \tau \\
 \text{curved arrow from } \mathcal{S} \text{ to } \mathcal{R} \times \mathcal{R}: \sigma \times id_{ver}(id(1_{\mathcal{R}}))
 \end{array}$$

We make the following observations.

(1) By definition of the 2-arrow

$$\mathcal{S} \xrightarrow{\left( id_{ver}(id(1_{\mathcal{R}})) \times \tau \right) \circ_{ver} \left( \sigma \times id_{ver}(id(1_{\mathcal{R}})) \right)} \mathcal{R} \times \mathcal{R},$$

of  $\mathcal{R}$ , the following diagram in 2-Cat commutes.

$$\begin{array}{ccc}
 \mathcal{S} & \xrightarrow{S_{ver}} & \mathcal{S}_n \sqcup_s \mathcal{S} \\
 \searrow \left( id_{ver}(id(1_{\mathcal{R}})) \times \tau \right) \circ_{ver} \left( \sigma \times id_{ver}(id(1_{\mathcal{R}})) \right) & & \downarrow u \\
 & & \mathcal{R} \times \mathcal{R}
 \end{array}$$

(2) By definition of the 2-arrow

$$\mathcal{S} \xrightarrow{\sigma \times id_{ver}(id(1_{\mathcal{R}}))} \mathcal{R} \times \mathcal{R},$$

of  $\mathcal{R}$ , the following diagram in 2-Cat commutes.

$$\begin{array}{ccc}
 \mathcal{S} & \xrightarrow{\sigma \times id_{ver}(id(1_{\mathcal{R}}))} & \mathcal{R} \times \mathcal{R} \\
 \searrow \sigma & & \downarrow p_1^{\mathcal{R}, bi} \\
 & & \mathcal{R}
 \end{array}$$



(3) By definition of the 2-arrow

$$\mathcal{S} \xrightarrow{id_{ver}(id(1_{\mathcal{R}})) \times \tau} \mathcal{R} \times \mathcal{R},$$

of  $\mathcal{R}$ , the following diagram in 2-Cat commutes.

$$\begin{array}{ccc} \mathcal{S} & \xrightarrow{id_{ver}(id(1_{\mathcal{R}})) \times \tau} & \mathcal{R} \times \mathcal{R} \\ & \searrow id_{ver}(id(1_{\mathcal{R}})) & \downarrow p_1^{\mathcal{R},bi} \\ & & \mathcal{R} \end{array}$$

(4) We deduce from (1) – (3) that the following diagram in 2-Cat commutes.

$$\begin{array}{ccccc} \mathcal{I} & \xrightarrow{n} & \mathcal{S} & & \\ \downarrow s & & \downarrow r_0^{\mathcal{S}_n \sqcup_s \mathcal{S}} & & \downarrow id_{ver}(id(1_{\mathcal{R}})) \\ \mathcal{S} & \xrightarrow{r_1^{\mathcal{S}_n \sqcup_s \mathcal{S}}} & \mathcal{S}_n \sqcup_s \mathcal{S} & \searrow & \mathcal{R} \\ & & & \downarrow p_1^{\mathcal{R},bi} \circ u & \\ & & & & \mathcal{R} \end{array}$$

$\sigma$

(5) Appealing to the universal property of  $\mathcal{S}_n \sqcup_s \mathcal{S}$ , and the definition of the 2-arrow  $id_{ver}(id(1_{\mathcal{R}})) \circ \sigma$ , we deduce from (4) that the following diagram in 2-Cat commutes.

$$\begin{array}{ccc} \mathcal{S} & \xrightarrow{\left(id_{ver}(id(1_{\mathcal{R}})) \times g\right) \circ \left(f \times id_{ver}(id(1_{\mathcal{R}}))\right)} & \mathcal{R} \times \mathcal{R} \\ & \searrow id_{ver}(id(1_{\mathcal{R}})) \circ_{ver} \sigma & \downarrow p_1^{\mathcal{R},bi} \\ & & \mathcal{R} \end{array}$$

(6) Since the 2-arrow  $id_{ver}(id(1_{\mathcal{R}})) \circ_{ver} \sigma$  is equal to  $\sigma$ , we deduce from (5) that the following diagram in 2-Cat commutes.

$$\begin{array}{ccc}
\mathcal{S} & \xrightarrow{\left( id_{ver}(id(1_{\mathcal{R}})) \times \tau \right) \circ_{ver} \left( \sigma \times (id(1_{\mathcal{R}})) \right)} & \mathcal{R} \times \mathcal{R} \\
& \searrow \sigma & \downarrow p_1^{\mathcal{R}, bi} \\
& & \mathcal{R}
\end{array}$$

(7) By an entirely analogous argument to that of (1) – (6), the following diagram in 2-Cat commutes.

$$\begin{array}{ccc}
\mathcal{S} & \xrightarrow{\left( id_{ver}(id(1_{\mathcal{R}})) \times \tau \right) \circ_{ver} \left( \sigma \times (id(1_{\mathcal{R}})) \right)} & \mathcal{R} \times \mathcal{R} \\
& \searrow g & \downarrow p_2^{\mathcal{R}, bi} \\
& & \mathcal{R}
\end{array}$$

(8) We deduce from (6), (7), the definition of the 2-arrow

$$\mathcal{S} \xrightarrow{\sigma \times \tau} \mathcal{R} \times \mathcal{R},$$

of  $\mathcal{R}$ , and the universal property of  $\mathcal{R} \times \mathcal{R}$ , that the 2-arrow

$$\left( id_{ver}(id(1_{\mathcal{R}})) \times \tau \right) \circ_{ver} \left( \sigma \times id_{ver}(id(1_{\mathcal{R}})) \right)$$

of  $\mathcal{R}$  is equal to the 2-arrow  $\sigma \times \tau$  of  $\mathcal{R}$ .

(9) We deduce from (8) that the following diagram in 2-Cat commutes.

$$\begin{array}{ccc}
\mathcal{S} & \xrightarrow{\left( id_{ver}(id(1_{\mathcal{R}})) \times \tau \right) \circ_{ver} \left( \sigma \times id_{ver}(id(1_{\mathcal{R}})) \right)} & \mathcal{R} \times \mathcal{R} \\
\sigma \times \tau \downarrow & & \downarrow \otimes_{\mathcal{R}} \\
\mathcal{R} \times \mathcal{R} & \xrightarrow{\otimes_{\mathcal{R}}} & \mathcal{R}
\end{array}$$

(10) Since  $\otimes_{\mathcal{R}}$  is a functor, we deduce from (9) that the 2-arrow

$$\left( id_{ver}(id(1_{\mathcal{R}}) \otimes_{\mathcal{R}} \tau) \right) \circ_{ver} \left( \sigma \otimes_{\mathcal{R}} id_{ver}(id(1_{\mathcal{R}})) \right)$$

of  $\mathcal{R}$  is equal to the 2-arrow  $\sigma \otimes_{\mathcal{R}} \tau$  of  $\mathcal{R}$ .

(11) By requirement (2) of Definition 2.1.1.3 with respect to  $\mathbf{R}^{\text{mult}}$ , the arrow  $id_{ver}(id(1_{\mathbf{R}})) \otimes_{\mathbf{R}} \tau$  of  $\mathcal{R}$  is equal to the arrow  $\tau$  of  $\mathcal{R}$ .

(12) By requirement (3) of Definition 2.1.1.3 with respect to  $\mathbf{R}^{\text{mult}}$ , the 2-arrow  $\sigma \otimes_{\mathbf{R}} id_{ver}(id(1_{\mathbf{R}}))$  of  $\mathcal{R}$  is equal to the 2-arrow  $\sigma$  of  $\mathcal{R}$ .

(13) We deduce from (10) – (12) that the arrow  $\tau \circ_{ver} \sigma$  of  $\mathcal{R}$  is equal to the 2-arrow  $\sigma \otimes_{\mathbf{R}} \tau$  of  $\mathcal{R}$ .

Working with the 2-arrow

$$\mathcal{S} \xrightarrow{\left( \tau \times id_{ver}(id(1_{\mathbf{R}})) \right) \circ_{ver} \left( id_{ver}(id(1_{\mathbf{R}})) \times \sigma \right)} \mathcal{R} \times \mathcal{R}$$

of  $\mathcal{R}$  instead of the 2-arrow

$$\mathcal{S} \xrightarrow{\left( id_{ver}(id(1_{\mathbf{R}})) \times \tau \right) \circ_{ver} \left( \sigma \times id_{ver}(id(1_{\mathbf{R}})) \right)} \mathcal{R} \times \mathcal{R}$$

of  $\mathcal{R}$ , an entirely analogous argument demonstrates that the arrow  $\tau \circ_{ver} \sigma$  of  $\mathcal{R}$  is also equal to the arrow  $\tau \otimes_{\mathbf{R}} \sigma$  of  $\mathcal{R}$ . Working with the 2-arrow

$$\mathcal{S} \xrightarrow{\left( \sigma \times id_{ver}(id(1_{\mathbf{R}})) \right) \circ_{ver} \left( id_{ver}(id(1_{\mathbf{R}})) \times \tau \right)} \mathcal{R} \times \mathcal{R}$$

of  $\mathcal{R}$  instead of the 2-arrow

$$\mathcal{S} \xrightarrow{\left( id_{ver}(id(1_{\mathbf{R}})) \times \tau \right) \circ_{ver} \left( \sigma \times id_{ver}(id(1_{\mathbf{R}})) \right)} \mathcal{R} \times \mathcal{R}$$

of  $\mathcal{R}$ , an entirely analogous argument demonstrates that the arrow  $\sigma \circ_{ver} \tau$  of  $\mathcal{R}$  is equal to the arrow  $\sigma \otimes_{\mathbf{R}} \tau$  of  $\mathcal{R}$ . Working with the 2-arrow

$$\mathcal{S} \xrightarrow{\left( id_{hor}(id(1_{\mathbf{R}})) \times \tau \right) \circ_{hor} \left( \sigma \times id_{hor}(id(1_{\mathbf{R}})) \right)} \mathcal{R} \times \mathcal{R}$$

instead of the 2-arrow

$$\mathcal{S} \xrightarrow{\left( id_{ver}(id(1_{\mathbf{R}})) \times \tau \right) \circ_{ver} \left( \sigma \times id_{ver}(id(1_{\mathbf{R}})) \right)} \mathcal{R} \times \mathcal{R}$$

of  $\mathcal{R}$ , an entirely analogous argument demonstrates that the arrow  $\tau \circ_{hor} \sigma$  of  $\mathcal{R}$  is equal to the arrow  $\sigma \otimes_{\mathbf{R}} \tau$  of  $\mathcal{R}$ . Finally, working with the 2-arrow

$$\mathcal{S} \xrightarrow{\left(\sigma \times id_{hor}(id(1_{\mathcal{R}}))\right) \circ_{hor} \left(id_{hor}(id(1_{\mathcal{R}})) \times \tau\right)} \mathcal{R} \times \mathcal{R}$$

of  $\mathcal{R}$  instead of the 2-arrow

$$\mathcal{S} \xrightarrow{\left(id_{ver}(id(1_{\mathcal{R}})) \times \tau\right) \circ_{ver} \left(\sigma \times id_{ver}(id(1_{\mathcal{R}}))\right)} \mathcal{R} \times \mathcal{R}$$

of  $\mathcal{R}$ , an entirely analogous argument demonstrates that the arrow  $\sigma \circ_{hor} \tau$  of  $\mathcal{R}$  is equal to the arrow  $\sigma \otimes_{\mathcal{R}} \tau$  of  $\mathcal{R}$ .

Putting all of this together, we have that

$$\tau \otimes_{\mathcal{R}} \sigma = \tau \circ_{ver} \sigma = \sigma \otimes_{\mathcal{R}} \tau = \sigma \circ_{ver} \tau$$

and that

$$\tau \circ_{hor} \sigma = \sigma \otimes_{\mathcal{R}} \tau = \sigma \circ_{hor} \tau.$$

Hence all six of these 2-arrows are equal. □

**Remark 2.1.3.22.** The proofs of Proposition 2.1.3.20 and Proposition 2.1.3.21 are a form of the *Eckmann-Hilton argument*. This argument, in a category theoretic setting, goes back to §4 of the paper [4] of Eckmann and Hilton.

## 2.2. Assumed free constructions

Certain free constructions of the internal algebraic structures introduced in §2.1 will be made vital use throughout this work. The first is that of free monoid internal to a category  $\mathcal{C}$  on a monoidal datum internal to  $\mathcal{C}$ . The second is that of a free ring internal to  $\mathcal{C}$  on a monoidal datum internal to  $\mathcal{C}$ . The third is that of a free ring internal to  $\mathcal{C}$  on a monoid internal to  $\mathcal{C}$ .

In this section, we introduce these free constructions, and relate them. That they can be carried out is demonstrated in [17].

### 2.2.1. Free monoid on a monoidal datum internal to a category

**Assumption 2.2.1.1.** Let  $\mathcal{C}$  be a category, and let  $1_{\mathcal{C}}$  be a final object of  $\mathcal{C}$ .

**Definition 2.2.1.2.** A *monoidal datum internal to  $\mathcal{C}$*  consists of the following data.

- (1) An object  $A$  of  $\mathcal{C}$ .
- (2) An object  $B$  of  $\mathcal{C}$
- (3) A diagram

$$B \xleftarrow{p_1^{B,bi}} B \times B \xrightarrow{p_2^{B,bi}} B$$

in  $\mathcal{C}$  which defines a binary product.

- (4) An arrow

$$A \xrightarrow{\text{pairs}} B \times B$$

of  $\mathcal{C}$ .

- (5) An arrow

$$A \xrightarrow{\text{to}} B$$

of  $\mathcal{C}$ .

**Definition 2.2.1.3.** Let  $\mathbb{M}$  be a monoid internal to  $\mathcal{C}$ . Let  $M$  be the object of  $\mathcal{C}$  which is part of the data of  $\mathbb{M}$ . A *monoidal datum for  $\mathbb{M}$*  consists of the following data.

- (1) A monoidal datum  $\mathbb{M}$  internal to  $\mathcal{C}$ .

(2) An arrow

$$B \xrightarrow{i} M$$

of  $\mathcal{C}$ .

Let

$$M \xleftarrow{p_1^{M,bi}} M \times M \xrightarrow{p_2^{M,bi}} M$$

be the diagram in  $\mathcal{C}$  which is part of the data of  $\mathbb{M}$ , and which defines a binary product. Let  $A$  and  $B$  be the objects of  $\mathcal{C}$  which are the first and second parts respectively of the data of  $\mathbb{M}$ , and let us denote the rest of the data of  $\mathbb{M}$  as follows.

$$B \xleftarrow{p_1^{B,bi}} B \times B \xrightarrow{p_2^{B,bi}} B$$

$$A \xrightarrow{\text{pairs}_{\mathbb{M}}} B \times B$$

$$A \xrightarrow{\text{to}_{\mathbb{M}}} B$$

We require that the following diagram in  $\mathcal{C}$  commutes.

$$\begin{array}{ccc}
 A & \xrightarrow{\text{pairs}_{\mathbb{M}}} & B \times B \\
 \downarrow \text{to}_{\mathbb{M}} & & \downarrow i \times i \\
 & & M \times M \\
 & & \downarrow \cdot_{\mathbb{M}} \\
 B & \xrightarrow{i} & M
 \end{array}$$

**Fact 2.2.1.4.** *Suppose that  $\mathcal{C}$  satisfies certain hypotheses, given in [17]. Let  $\mathbb{M}$  be a monoidal datum internal to  $\mathcal{C}$ , and let  $B$  be the object of  $\mathcal{C}$  which is the second part of the data of  $\mathbb{M}$ . Then there is a monoid  $F(\mathbb{M})$  internal to  $\mathcal{C}$ , and an arrow*

$$B \xrightarrow{i_{F(\mathbb{M})}} F(\mathbb{M})$$

of  $\mathcal{C}$ , where  $F(\mathbb{M})$  is the object of  $\mathcal{C}$  which is part of the data of  $\mathbb{M}$ , such that, for every monoid  $M$  internal to  $\mathcal{C}$ , and every arrow

$$B \xrightarrow{i_M} M$$

of  $\mathcal{C}$  with the property that  $(\mathbb{M}, i_M)$  defines a monoidal datum for  $M$ , where  $M$  is the object of  $\mathcal{C}$  which is part of the data of  $\mathbb{M}$ , there is a unique arrow

$$F(\mathbb{M}) \xrightarrow{\text{can}_M} M$$

of  $\mathcal{C}$  with the following properties.

- (1) The data  $(\mathbb{M}, i_{F(\mathbb{M})})$  defines a monoidal datum for  $F(\mathbb{M})$ .
- (2) The arrow  $\text{can}_M$  of  $\mathcal{C}$  defines a morphism from  $F(\mathbb{M})$  to  $M$ .
- (3) The following diagram in  $\mathcal{C}$  commutes.

$$\begin{array}{ccc} B & \xrightarrow{i_{F(\mathbb{M})}} & F(\mathbb{M}) \\ & \searrow i_M & \downarrow \text{can}_M \\ & & M \end{array}$$

**Terminology 2.2.1.5.** We refer to  $F(\mathbb{M})$  as the *free monoid on  $\mathbb{M}$* .

**Remark 2.2.1.6.** Both  $\text{Cat}$  and  $2\text{-Cat}$  satisfy the hypotheses required to hold at the beginning of Fact 2.2.1.4.

**Terminology 2.2.1.7.** Suppose that  $\mathcal{C}$  has an initial object  $\emptyset_{\mathcal{C}}$ . Let  $B$  be an object of  $\mathcal{C}$ . Assume that there is a diagram

$$B \xleftarrow{p_1^{B,bi}} B \times B \xrightarrow{p_2^{B,bi}} B$$

in  $\mathcal{C}$  which defines a binary product. Let  $\mathbb{M}$  be the monoidal datum given by the following data.

- (1) The object of  $\mathcal{C}$  which is the first part of the data of  $\mathbb{M}$  is  $\emptyset_{\mathcal{C}}$ .
- (2) The object of  $\mathcal{C}$  which is the second part of the data of  $\mathbb{M}$  is  $B$ .
- (3) The diagram in  $\mathcal{C}$  which is the third part of the data of  $\mathbb{M}$  is the following.

$$B \xleftarrow{p_1^{B,bi}} B \times B \xrightarrow{p_2^{B,bi}} B$$

(4) The arrow

$$\emptyset_{\mathcal{C}} \xrightarrow{\text{pairs}} B \times B$$

is the canonical arrow to which the universal property of  $\emptyset_{\mathcal{C}}$  gives rise.

(5) The arrow

$$\emptyset_{\mathcal{C}} \xrightarrow{\text{to}} B$$

is the canonical arrow to which the universal property of  $\emptyset_{\mathcal{C}}$  gives rise.

Then we refer to the free monoid on  $\mathbb{M}$  as the *free monoid on  $B$* .

## 2.2.2. Free ring on a monoidal datum internal to a category

**Definition 2.2.2.1.** Let  $\mathbb{R}$  be a ring internal to  $\mathcal{C}$ . A *monoidal datum for  $\mathbb{R}$*  is a monoidal datum for  $\mathbb{R}^{\text{mult}}$ .

**Fact 2.2.2.2.** Suppose that  $\mathcal{C}$  satisfies certain hypotheses, given in [17]. Let  $\mathbb{M} = (A, B, \text{pairs}_{\mathbb{M}}, \text{to}_{\mathbb{M}})$  be a monoidal datum internal to  $\mathcal{C}$ . Then there is a ring  $F(\mathbb{M})$  internal to  $\mathcal{C}$ , and an arrow

$$B \xrightarrow{i_{F(\mathbb{M})}} F(\mathbb{M})$$

of  $\mathcal{C}$ , where  $F(\mathbb{M})$  is the object of  $\mathcal{C}$  which is part of the data of  $F(\mathbb{M})$ , such that, for every ring  $\mathbb{R}$  internal to  $\mathcal{C}$ , and every arrow

$$B \xrightarrow{i_{\mathbb{R}}} \mathbb{R}$$

of  $\mathcal{C}$  with the property that  $(\mathbb{M}, i_{\mathbb{R}})$  defines a monoidal datum for  $\mathbb{M}$ , where  $\mathbb{R}$  is the object of  $\mathcal{C}$  which is part of the data of  $\mathbb{R}$ , there is a unique arrow

$$F(\mathbb{M}) \xrightarrow{\text{can}_{\mathbb{M}}} \mathbb{R}$$

of  $\mathcal{C}$  with the following properties.

- (1) The data  $(\mathbb{M}, i_{F(\mathbb{M})})$  defines a monoidal datum for  $F(\mathbb{M})$ .
- (2) The arrow  $\text{can}_{\mathbb{M}}$  of  $\mathcal{C}$  defines a morphism from  $F(\mathbb{M})$  to  $\mathbb{R}$ .



(3) The following diagram in  $\mathcal{C}$  commutes.

$$\begin{array}{ccc} B & \xrightarrow{i_{F(\mathbb{M})}} & F(\mathbb{M}) \\ & \searrow i_R & \downarrow \text{can}_{\mathbb{M}} \\ & & R \end{array}$$

**Terminology 2.2.2.3.** We refer to  $F(\mathbb{M})$  as the *free ring on  $\mathbb{M}$* .

**Remark 2.2.2.4.** Both  $\text{Cat}$  and  $2\text{-Cat}$  satisfy the hypotheses required to hold at the beginning of Fact 2.2.2.2.

**Terminology 2.2.2.5.** Suppose that  $\mathcal{C}$  has an initial object  $\emptyset_{\mathcal{C}}$ . Let  $B$  be an object of  $\mathcal{C}$ . Assume that there is a diagram

$$B \xleftarrow{p_1^{B,bi}} B \times B \xrightarrow{p_2^{B,bi}} B$$

in  $\mathcal{C}$  which defines a binary product. Let  $\mathbb{M}$  be the monoidal datum defined as in Terminology 2.2.1.7. Then we refer to the free ring on  $\mathbb{M}$  as the *free ring on  $B$* .

### 2.2.3. Free ring on a monoid internal to a category

**Fact 2.2.3.1.** Suppose that  $\mathcal{C}$  satisfies certain hypotheses, given in [17]. Let  $\mathbb{M}$  be a monoid internal to  $\mathcal{C}$ . Then there is a ring  $F(\mathbb{M})$  internal to  $\mathcal{C}$ , and a morphism

$$\mathbb{M} \xrightarrow{i_{F(\mathbb{M})}} F(\mathbb{M})^{\text{mult}}$$

of monoids internal to  $\mathcal{C}$ , such that, for every ring  $R$  internal to  $\mathcal{C}$ , and every morphism

$$\mathbb{M} \xrightarrow{f} R^{\text{mult}}$$

of monoids internal to  $\mathcal{C}$ , there is a unique morphism

$$F(\mathbb{M}) \xrightarrow{\text{can}_R} R$$

of rings internal to  $\mathcal{C}$  such that the following diagram in  $\text{Mon}(\mathcal{C})$  commutes.

$$\begin{array}{ccc} \mathbb{M} & \xrightarrow{i_{F(\mathbb{M})}} & F(\mathbb{M})^{\text{mult}} \\ & \searrow f & \downarrow \text{can}_R \\ & & R \end{array}$$

**Terminology 2.2.3.2.** We refer to  $F(\mathbb{M})$  as the *free ring on  $\mathbb{M}$* .

**Remark 2.2.3.3.** Both  $\mathcal{C}\text{-Cat}$  and  $2\text{-Cat}$  satisfy the hypotheses required to hold at the beginning of Fact 2.2.3.1.

**Fact 2.2.3.4.** *Suppose that  $\mathcal{C}$  satisfies the hypotheses that are required to hold at the beginning of Fact 2.2.1.4 and Fact 2.2.2.2. Let  $\mathbb{M}$  be a monoidal datum internal to  $\mathcal{C}$ , and let  $B$  be the object of  $\mathcal{C}$  which is the second part of the data of  $\mathbb{M}$ . Appealing to Fact 2.2.1.4, let  $F_{\text{Mon}(\mathcal{C})}(\mathbb{M})$  denote the free monoid on  $\mathbb{M}$  internal to  $\mathcal{C}$ . Appealing to Fact 2.2.2.2, let  $F_{\text{Ring}(\mathcal{C})}(\mathbb{M})$  denote the free ring on  $\mathbb{M}$  internal to  $\mathcal{C}$ . Let us denote by*

$$F_{\text{Mon}(\mathcal{C})}(\mathbb{M}) \xrightarrow{u} F_{\text{Ring}(\mathcal{C})}(\mathbb{M})^{\text{mult}}$$

*the morphism of monoids internal to  $\mathcal{C}$  to which the monoid  $F_{\text{Ring}(\mathcal{C})}(\mathbb{M})^{\text{mult}}$  internal to  $\mathcal{C}$  and the arrow*

$$B \xrightarrow{i_{F_{\text{Ring}(\mathcal{C})}(\mathbb{M})}} F_{\text{Ring}(\mathcal{C})}(\mathbb{M})$$

*of  $\mathcal{C}$  give rise, by means of the universal property of  $F_{\text{Mon}(\mathcal{C})}(\mathbb{M})$ . Then  $F_{\text{Ring}(\mathcal{C})}(\mathbb{M})^{\text{mult}}$  along with the morphism*

$$F_{\text{Mon}(\mathcal{C})}(\mathbb{M}) \xrightarrow{u} F_{\text{Ring}(\mathcal{C})}(\mathbb{M})^{\text{mult}},$$

*of monoids internal to  $\mathcal{C}$  define the free ring on  $F_{\text{Mon}(\mathcal{C})}(\mathbb{M})$  internal to  $\mathcal{C}$ .*



---

---

## CHAPTER 3

---

# A CATEGORICAL FRAMEWORK FOR THE KAUFFMAN BRACKET

## 3.1. Categories of braids

We define a category **Braids**, whose arrows we think of and depict as braids. as a free strict monoidal category on a monoidal datum  $\mathbb{M}_{\text{Braids}}$ . We then formulate the R2 and R3 Reidemeister moves in terms of arrows of **Braids**, and define a series of monoidal categories by taking colimits in  $\text{Mon}(\text{Cat})$  which identify the two sides of each of these moves. First, a category **Braids/R2<sub>one</sub>** in which one of the R2 moves has been forced to become an identity. Second, a category **Braids/R2<sub>both</sub>** in which both of the R2 moves have been forced to become identities. Finally, a category **Braids/R-moves** in which all of the R2 and R3 moves have been forced to become identities.

We think of the arrows of **Braids/R-moves** as braids up to isotopy. More generally, we think of our work in this section as carrying out an algebraisation of the topological theory of braids.

We observe that, to define **Braids/R-moves** from **Braids/R2<sub>both</sub>**, it is enough to force just one of the R3 moves to become an identity. All of the other R3 moves then become identities as a consequence. Making use of this observation, and of the categories **Braids/R2<sub>one</sub>** and **Braids/R2<sub>both</sub>**, rather than defining **Braids/R-moves** from **Braids** in one step, will allow us to demonstrate in as short a manner as possible that the Kauffman bracket we construct in §3.3 is a braid invariant.

### 3.1.1. The category of braids

**Notation 3.1.1.1.** Let

$$1_{\text{Cat}} \xrightarrow{1} 1_{\text{Cat}} \sqcup 1_{\text{Cat}} \xleftarrow{2} 1_{\text{Cat}}$$

be a diagram in  $\text{Cat}$  which defines a binary coproduct.

**Notation 3.1.1.2.** Let us denote by

$$\partial\mathcal{I} \xrightarrow{(2,2)} 1_{\text{Cat}} \sqcup 1_{\text{Cat}}$$

the functor determined by the pair of objects  $(2, 2)$  of  $1_{\text{Cat}} \sqcup 1_{\text{Cat}}$ .

**Notation 3.1.1.3.** Let us denote by

$$\partial\mathcal{I} \xrightarrow{(0,1)} \mathcal{I}$$

the functor determined by the pair of objects  $(0, 1)$  of  $\mathcal{I}$ .

**Notation 3.1.1.4.** Let

$$\partial\mathcal{I} \xrightarrow{i_1^{\partial\mathcal{I},bi}} \partial\mathcal{I} \sqcup \partial\mathcal{I} \xleftarrow{i_2^{\partial\mathcal{I},bi}} \partial\mathcal{I}$$

be a diagram in  $\text{Cat}$  which defines a binary coproduct.

**Notation 3.1.1.5.** Let us denote by

$$\partial\mathcal{I} \sqcup \partial\mathcal{I} \xrightarrow{(2,2) \sqcup (2,2)} 1_{\text{Cat}} \sqcup 1_{\text{Cat}}$$

the canonical functor such that the following diagram in  $\text{Cat}$ , in which it is the unlabelled vertical arrow, commutes.

$$\begin{array}{ccccc} \partial\mathcal{I} & \xrightarrow{i_1^{\partial\mathcal{I},bi}} & \partial\mathcal{I} \sqcup \partial\mathcal{I} & \xleftarrow{i_2^{\partial\mathcal{I},bi}} & \partial\mathcal{I} \\ & \searrow (2,2) & \downarrow & \swarrow (2,2) & \\ & & 1_{\text{Cat}} \sqcup 1_{\text{Cat}} & & \end{array}$$

**Notation 3.1.1.6.** Let

$$\mathcal{I} \xrightarrow{i_1^{\mathcal{I},bi}} \mathcal{I} \sqcup \mathcal{I} \xleftarrow{i_2^{\mathcal{I},bi}} \mathcal{I}$$

be a diagram in  $\text{Cat}$  which defines a binary coproduct.

**Notation 3.1.1.7.** Let us denote by

$$\partial\mathcal{I} \sqcup \partial\mathcal{I} \xrightarrow{((0,1) \sqcup (0,1))} \mathcal{I} \sqcup \mathcal{I}$$

the canonical functor such that the following diagram in  $\text{Cat}$ , in which it is the unlabelled vertical arrow, commutes.

$$\begin{array}{ccccc} \partial\mathcal{I} & \xrightarrow{i_1^{\partial\mathcal{I},bi}} & \partial\mathcal{I} \sqcup \partial\mathcal{I} & \xleftarrow{i_2^{\partial\mathcal{I},bi}} & \partial\mathcal{I} \\ & \searrow i_1^{\mathcal{I},bi} \circ (0,1) & \downarrow & \swarrow i_2^{\mathcal{I},bi} \circ (0,1) & \\ & & \mathcal{I} \sqcup \mathcal{I} & & \end{array}$$

**Notation 3.1.1.8.** Let

$$\begin{array}{ccc} \partial\mathcal{I} \sqcup \partial\mathcal{I} & \xrightarrow{(2,2) \sqcup (2,2)} & 1_{\text{Cat}} \sqcup 1_{\text{Cat}} \\ (0,1) \sqcup (0,1) \downarrow & & \downarrow r_0^{\text{Braids}_{\leq 2}} \\ \mathcal{I} \sqcup \mathcal{I} & \xrightarrow{r_1^{\text{Braids}_{\leq 2}}} & \text{Braids}_{\leq 2} \end{array}$$

be a co-cartesian square in  $\text{Cat}$ .

**Notation 3.1.1.9.** We denote the object of  $\mathbf{Braids}_{\leq 2}$  corresponding to the functor

$$1_{\text{Cat}} \xrightarrow{r_0^{\mathbf{Braids}_{\leq 2}} \circ 1} \mathbf{Braids}_{\leq 2}$$

by 1, and depict it as follows.

•

We denote the object of  $\mathbf{Braids}_{\leq 2}$  corresponding to the functor

$$1_{\text{Cat}} \xrightarrow{r_0^{\mathbf{Braids}_{\leq 2}} \circ 2} \mathbf{Braids}_{\leq 2}$$

by 2, and depict it as follows.

• •

We depict the arrow

$$1 \xrightarrow{id(1)} 1$$

of  $\mathbf{Braids}_{\leq 2}$  as follows.

•  
|  
•

We depict the arrow

$$2 \xrightarrow{id(2)} 2$$

of  $\mathbf{Braids}_{\leq 2}$  as follows.

• •  
| |  
• •

We denote the arrow of  $\mathbf{Braids}_{\leq 2}$  corresponding to the functor

$$\mathcal{I} \xrightarrow{r_1^{\text{Braids}_{\leq 2}} \circ i_1^{\mathcal{I}, bi}} \text{Braids}_{\leq 2}$$

by **OverCrossing**, and depict it as follows.

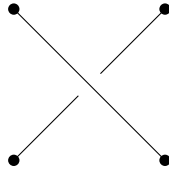

We denote the arrow of  $\text{Braids}_{\leq 2}$  corresponding to the functor

$$\mathcal{I} \xrightarrow{r_1^{\text{Braids}_{\leq 2}} \circ i_2^{\mathcal{I}, bi}} \text{Braids}_{\leq 2}$$

by **UnderCrossing**, and depict it as follows.

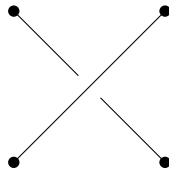

**Remark 3.1.1.10.** The definition of  $\text{Braids}_{\leq 2}$  can be thought of as follows. We begin with a category consisting of exactly two objects, 1 and 2, and no non-identity arrows. We then proceed as follows.

(1) We add an arrow

$$2 \longrightarrow 2,$$

which we denote by **OverCrossing**.

(2) We add another arrow

$$2 \longrightarrow 2,$$

which we denote by **UnderCrossing**.



(3) We then add exactly those further arrows

$$2 \longrightarrow 2$$

that we need to have a category, namely arbitrary finite compositions of **OverCrossing** and **UnderCrossing**.

As this description makes clear,  $\mathbf{Braids}_{\leq 2}$  can also be defined as the free category on the directed graph consisting of exactly two objects 1, 2, and exactly two arrows

$$2 \longrightarrow 2.$$

We prefer, however, the more direct approach, working purely within  $\mathbf{Cat}$ , that we have taken.

**Notation 3.1.1.11.** Let

$$\mathbf{Braids}_{\leq 2} \xleftarrow[p_1]{\mathbf{Braids}_{\leq 2}} \mathbf{Braids}_{\leq 2} \times \mathbf{Braids}_{\leq 2} \xrightarrow[p_2]{\mathbf{Braids}_{\leq 2}} \mathbf{Braids}_{\leq 2}$$

be a diagram in  $\mathbf{Cat}$  which defines a binary product.

**Notation 3.1.1.12.** Let

$$1_{\mathbf{Cat}} \xrightarrow{(1,1)} \mathbf{Braids}_{\leq 2} \times \mathbf{Braids}_{\leq 2}$$

be the canonical functor such that the following diagram in  $\mathbf{Cat}$  commutes.

$$\begin{array}{ccccc} & & 1_{\mathbf{Cat}} & & \\ & \swarrow 1 & \downarrow (1,1) & \searrow 1 & \\ \mathbf{Braids}_{\leq 2} & \xleftarrow[p_1]{\mathbf{Braids}_{\leq 2}} & \mathbf{Braids}_{\leq 2} \times \mathbf{Braids}_{\leq 2} & \xrightarrow[p_2]{\mathbf{Braids}_{\leq 2}} & \mathbf{Braids}_{\leq 2} \end{array}$$

**Definition 3.1.1.13.** The *category of braids* is, appealing to Fact 2.2.1.4, the free strict monoidal category on the monoidal datum  $\mathbb{M}_{\mathbf{Braids}} = (1_{\mathbf{Cat}}, \mathbf{Braids}_{\leq 2}, (1,1), 2)$  internal to  $\mathbf{Cat}$ .

**Notation 3.1.1.14.** We denote the category of braids by  $\mathbf{Braids}$ . We denote the canonical functor

$$\mathbf{Braids}_{\leq 2} \longrightarrow \mathbf{Braids}$$

by  $\text{can}_{\mathbf{Braids}}$ .

**Remark 3.1.1.15.** The construction of the category **Braids** can be thought as taking the free strict monoidal category upon  $\mathbf{Braids}_{\leq 2}$ , subject to the requirement that  $1 \otimes 1 = 2$ . Thus the objects of **Braids** can be thought of as the symbols

$$\underbrace{1 \otimes \cdots \otimes 1}_n$$

for  $n \geq 0$ . We depict

$$\underbrace{1 \otimes \cdots \otimes 1}_n$$

as follows, for  $n \geq 1$ .

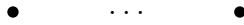

We sometimes denote the symbol

$$\underbrace{1 \otimes \cdots \otimes 1}_n$$

simply by  $n$ .

The arrows of **Braids** can be thought of as built from those of  $\mathbf{Braids}_{\leq 2}$  by horizontal concatenation. Thus, for instance, there is an arrow

$$1 \otimes 1 \otimes 1 \xrightarrow{id(1) \otimes \text{OverCrossing}} 1 \otimes 1 \otimes 1,$$

which we depict as follows.

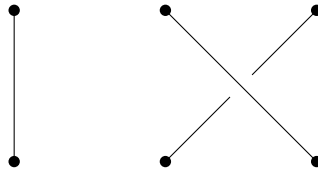

We think of the unit object of **Braids**, which we denote by  $0$ , as the ‘empty braid’, or the ‘braid with zero strands’.

From this description, we see that the arrows of **Braids** correspond exactly to braids, on any number of strands, in the topological sense. However, we shall not make use of this or any other explicit description of **Braids** in our formal work. We shall appeal only to its universal property.

**Notation 3.1.1.16.** We depict composition in both  $\mathbf{Braids}_{\leq 2}$  and **Braids** as vertical glueing. For instance, we depict the arrow

$$2 \xrightarrow{\text{UnderCrossing} \circ \text{OverCrossing}} 2$$

in either  $\text{Braids}_{\leq 2}$  or  $\text{Braids}$  as follows.

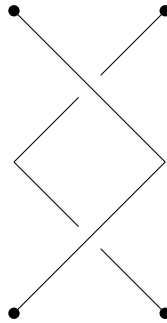

### 3.1.2. Categories of braids up to isotopy

**Notation 3.1.2.1.** Appealing to Fact 2.2.1.4, we denote by  $F(\mathcal{I})$  the free strict monoidal category on  $\mathcal{I}$ .

**Notation 3.1.2.2.** Let

$$F(\mathcal{I}) \xrightarrow{R2_{\text{one}}(\text{one half})} \text{Braids}$$

be the strict monoidal functor to which, by means of the universal property of  $F(\mathcal{I})$ , the functor

$$\mathcal{I} \xrightarrow{\text{UnderCrossing} \circ \text{OverCrossing}} \text{Braids}$$

gives rise.

**Notation 3.1.2.3.** Let

$$F(\mathcal{I}) \xrightarrow{R2_{\text{one}}(\text{other half})} \text{Braids}$$

be the strict monoidal functor to which, by means of the universal property of  $F(\mathcal{I})$ , the functor

$$\mathcal{I} \longrightarrow \text{Braids}$$

corresponding to the arrow

$$2 \xrightarrow{id} 2$$

of  $\text{Braids}$  gives rise.

**Definition 3.1.2.4.** Appealing to Fact 2.1.1.13, let

$$F(\mathcal{I}) \begin{array}{c} \xrightarrow{R2_{\text{one}}(\text{one half})} \\ \xrightarrow{R2_{\text{one}}(\text{other half})} \end{array} \text{Braids} \xrightarrow{q_{R2_{\text{one}}}} \text{Braids}/R2_{\text{one}}$$

be a diagram in  $\text{Mon}(\text{Cat})$  which defines a coequaliser.

**Remark 3.1.2.5.** The arrows  $R2_{\text{one}}(\text{one half})$  and  $R2_{\text{one}}(\text{other half})$  of  $\text{Braids}$  express algebraically the two halves of the R2 move which allows us to replace

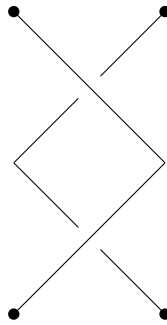

by the following, and vice versa.

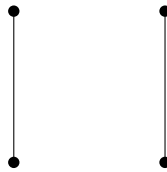

We refer to this R2 move as  $R2_{\text{one}}$ . Let us regard two braids as equivalent if one can be obtained from the other by a finite sequence of  $R2_{\text{one}}$  moves. Then the objects of  $\text{Braids}/R2_{\text{one}}$  are the same as those of  $\text{Braids}$ , and the arrows of  $\text{Braids}/R2_{\text{one}}$  can be thought of in the same way as the arrows of  $\text{Braids}$ , namely as braids, up to the afore-mentioned notion of equivalence.

**Notation 3.1.2.6.** Let

$$F(\mathcal{I}) \xrightarrow{R2_{\text{two}}(\text{one half})} \text{Braids}$$

be the strict monoidal functor to which, by means of the universal property of  $F(\mathcal{I})$ , the functor

$$\mathcal{I} \xrightarrow{\text{OverCrossing} \circ \text{UnderCrossing}} \text{Braids}$$

gives rise.

**Notation 3.1.2.7.** Let

$$F(\mathcal{I}) \xrightarrow{R2_{\text{two}}(\text{other half})} \text{Braids}$$

be the strict monoidal functor to which, by means of the universal property of  $F(\mathcal{I})$ , the functor

$$\mathcal{I} \longrightarrow \text{Braids}$$

corresponding to the arrow

$$2 \xrightarrow{id} 2$$

of  $\text{Braids}$  gives rise.

**Definition 3.1.2.8.** Appealing to Fact 2.1.1.13, let

$$F(\mathcal{I}) \begin{array}{c} \xrightarrow{q_{R2_{\text{one}}} \circ R2_{\text{two}}(\text{one half})} \\ \xrightarrow{q_{R2_{\text{one}}} \circ R2_{\text{two}}(\text{other half})} \end{array} \text{Braids}/R2_{\text{one}} \xrightarrow{q_{R2_{\text{two}}}} \text{Braids}/R2_{\text{both}}$$

be a diagram in  $\text{Mon}(\text{Cat})$  which defines a coequaliser.

**Notation 3.1.2.9.** We denote the functor

$$\text{Braids} \xrightarrow{q_{R2_{\text{two}}} \circ q_{R2_{\text{one}}}} \text{Braids}/R2_{\text{both}}$$

by  $q_{R2_{\text{both}}}$ .

**Remark 3.1.2.10.** The arrows  $R2_{\text{two}}(\text{one half})$  and  $R2_{\text{two}}(\text{other half})$  of  $\text{Braids}$  express algebraically the two halves of the R2 move which allows us to replace

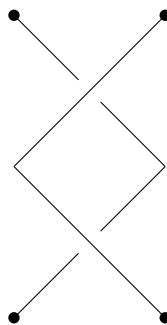

by the following, and vice versa.

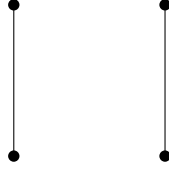

We refer to this  $R2$  move as  $R2_{\text{two}}$ . Let us regard two braids as equivalent if one can be obtained from the other by a finite sequence of  $R2_{\text{one}}$  and  $R2_{\text{two}}$  moves. Then the objects of  $\mathbf{Braids}/R2_{\text{both}}$  are the same as those of  $\mathbf{Braids}$ , and the arrows of  $\mathbf{Braids}/R2_{\text{both}}$  can be thought of in the same way as the arrows of  $\mathbf{Braids}$ , namely as braids, up to the afore-mentioned notion of equivalence.

**Remark 3.1.2.11.** The category  $\mathbf{Braids}/R2_{\text{both}}$  is in fact a groupoid. The arrows

$$2 \xrightarrow{\text{OverCrossing}} 2$$

and

$$2 \xrightarrow{\text{UnderCrossing}} 2$$

of  $\mathbf{Braids}_{\leq 2}$  are the non-identity generating arrows for  $\mathbf{Braids}$  as the free strict monoidal category on  $\mathbb{M}_{\mathbf{Braids}}$ . Since these two arrows become inverse to one another in  $\mathbf{Braids}/R2_{\text{both}}$ , it follows that all arrows of  $\mathbf{Braids}$  become isomorphisms in  $\mathbf{Braids}/R2_{\text{both}}$ .

The observation that  $\mathbf{Braids}/R2_{\text{both}}$  is a groupoid will not be made use of in this work.

**Notation 3.1.2.12.** Let us denote the arrow

$$3 \xrightarrow{\text{OverCrossing} \otimes id(1)} 3$$

of  $\mathbf{Braids}$  by  $\sigma_1$ . Let us denote the arrow

$$3 \xrightarrow{id(1) \otimes \text{OverCrossing}} 3$$

of  $\mathbf{Braids}$  by  $\sigma_2$ .

**Notation 3.1.2.13.** Let

$$F(\mathcal{I}) \xrightarrow{R3_{\text{one}}(\text{one half})} \mathbf{Braids}$$

be the strict monoidal functor to which, by means of the universal property of  $F(\mathcal{I})$ , the functor

$$\mathcal{I} \xrightarrow{\sigma_1 \circ \sigma_2 \circ \sigma_1} \mathbf{Braids}$$

gives rise.

**Notation 3.1.2.14.** Let

$$F(\mathcal{I}) \xrightarrow{R3_{\text{one}}(\text{other half})} \text{Braids}$$

be the strict monoidal functor to which, by means of the universal property of  $F(\mathcal{I})$ , the functor

$$\mathcal{I} \xrightarrow{\sigma_2 \circ \sigma_1 \circ \sigma_2} \text{Braids}$$

gives rise.

**Definition 3.1.2.15.** Appealing to Fact 2.1.1.13, let

$$F(\mathcal{I}) \begin{array}{c} \xrightarrow{q_{R2_{\text{both}}} \circ R3_{\text{one}}(\text{one half})} \\ \xrightarrow{q_{R2_{\text{both}}} \circ R3_{\text{one}}(\text{other half})} \end{array} \text{Braids}/R2_{\text{both}} \xrightarrow{q_{R3_{\text{one}}}} \text{Braids}/R\text{-moves}$$

be a diagram in  $\text{Mon}(\text{Cat})$  which defines a coequaliser.

**Notation 3.1.2.16.** We denote the functor

$$\text{Braids} \xrightarrow{q_{R3_{\text{one}}} \circ q_{R2_{\text{both}}}} \text{Braids}/R\text{-moves}$$

by  $q_{R\text{-moves}}$ .

**Remark 3.1.2.17.** The arrows  $R3_{\text{one}}(\text{one half})$  and  $R3_{\text{one}}(\text{other half})$  of  $\text{Braids}$  express algebraically the two halves of the  $R3$  move which allows us to replace

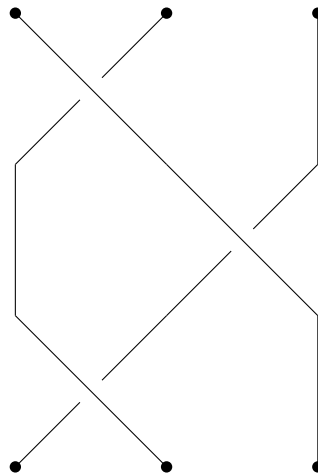

by the following, and vice versa.

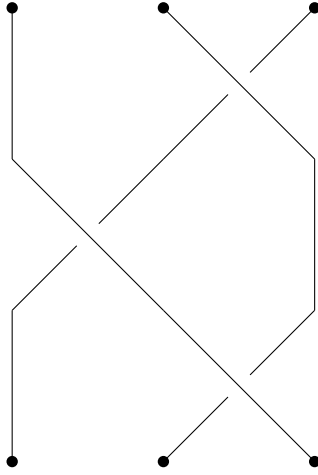

We refer to this R3 move as  $R3_{\text{one}}$ .

**Notation 3.1.2.18.** Let us denote the arrow

$$3 \xrightarrow{\text{UnderCrossing} \otimes id(1)} 3$$

of Braids by  $\sigma_1^{-1}$ . Let us denote the arrow

$$3 \xrightarrow{id(1) \otimes \text{UnderCrossing}} 3$$

of Braids by  $\sigma_2^{-2}$ .

**Notation 3.1.2.19.** Let

$$F(\mathcal{I}) \xrightarrow{R3_{\text{two}}(\text{one half})} \text{Braids}$$

be the strict monoidal functor to which, by means of the universal property of  $F(\mathcal{I})$ , the functor

$$\mathcal{I} \xrightarrow{\sigma_1^{-1} \circ \sigma_2 \circ \sigma_1} \text{Braids}$$

gives rise.

**Notation 3.1.2.20.** Let

$$F(\mathcal{I}) \xrightarrow{R3_{\text{two}}(\text{other half})} \text{Braids}$$

be the strict monoidal functor to which, by means of the universal property of  $F(\mathcal{I})$ , the functor





$$\begin{array}{ccc}
\mathcal{I} & \xrightarrow{\sigma_1^{-1} \circ \sigma_2 \circ \sigma_1} & \text{Braids} \\
\downarrow \sigma_2 \circ \sigma_1 \circ \sigma_2^{-1} & & \downarrow q_{\text{R-moves}} \\
\text{Braids} & \xrightarrow{q_{\text{R-moves}}} & \text{Braids/R-moves}
\end{array}$$

*Proof.* We make the following observations.

(1) By definition of Braids/R-moves, the following diagram in  $\text{Cat}$  commutes.

$$\begin{array}{ccc}
\mathcal{I} & \xrightarrow{\sigma_1 \circ \sigma_2 \circ \sigma_1} & \text{Braids} \\
\downarrow \sigma_2 \circ \sigma_1 \circ \sigma_2 & & \downarrow q_{\text{R-moves}} \\
\text{Braids} & \xrightarrow{q_{\text{R-moves}}} & \text{Braids/R-moves}
\end{array}$$

(2) By the functoriality of  $q_{\text{R-moves}}$ , we deduce from (1) that the following diagram in  $\text{Cat}$  commutes.

$$\begin{array}{ccc}
\mathcal{I} & \xrightarrow{\sigma_1^{-1} \circ \sigma_1 \circ \sigma_2 \circ \sigma_1} & \text{Braids} \\
\downarrow \sigma_1^{-1} \circ \sigma_2 \circ \sigma_1 \circ \sigma_2 & & \downarrow q_{\text{R-moves}} \\
\text{Braids} & \xrightarrow{q_{\text{R-moves}}} & \text{Braids/R-moves}
\end{array}$$

(3) By definition of Braids/R2<sub>one</sub>, the following diagram in  $\text{Cat}$  commutes.

$$\begin{array}{ccc}
\mathcal{I} & \xrightarrow{id(2)} & \text{Braids} \\
\downarrow \sigma_1^{-1} \circ \sigma_1 & & \downarrow q_{\text{R2}_{\text{both}}} \\
\text{Braids} & \xrightarrow{q_{\text{R2}_{\text{both}}}} & \text{Braids/R2}_{\text{one}}
\end{array}$$

(4) We deduce from (3) that the following diagram in  $\text{Cat}$  commutes.

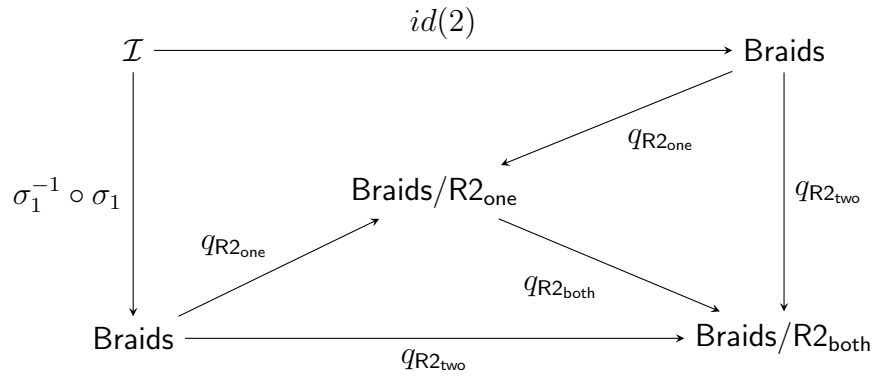

(5) We deduce from (4) that the following diagram in  $\text{Cat}$  commutes.

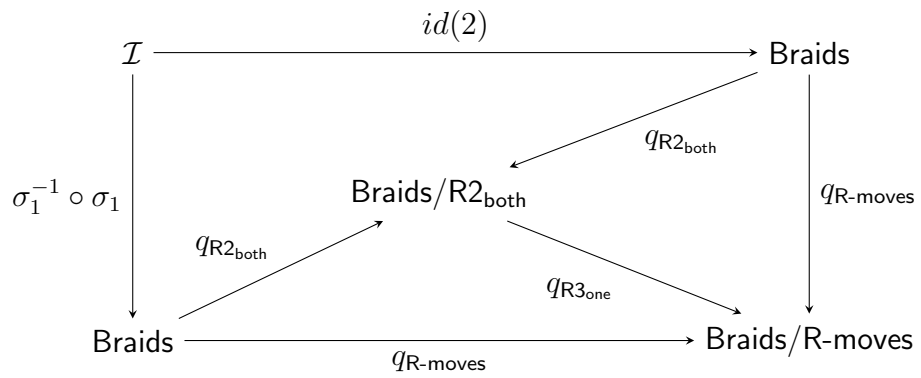

(6) By the functoriality  $q_{R\_moves}$ , we deduce from (5) that the following diagram in  $\text{Cat}$  commutes.

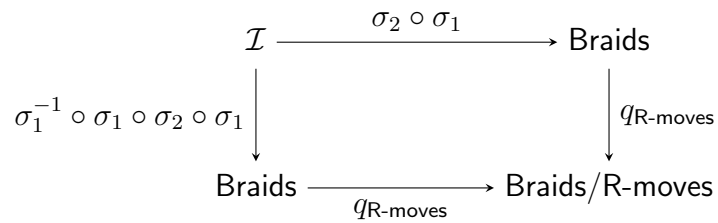

(7) We deduce from (2) and (6) that the following diagram in  $\text{Cat}$  commutes.

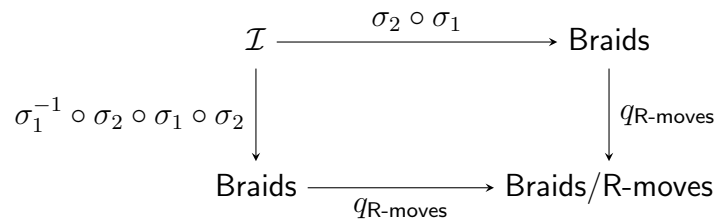

(8) By the functoriality  $q_{R\text{-moves}}$ , we deduce from (7) that the following diagram in  $\mathbf{Cat}$  commutes.

$$\begin{array}{ccc}
 \mathcal{I} & \xrightarrow{\sigma_2 \circ \sigma_1 \circ \sigma_2^{-1}} & \mathbf{Braids} \\
 \sigma_1^{-1} \circ \sigma_2 \circ \sigma_1 \circ \sigma_2 \circ \sigma_2^{-1} \downarrow & & \downarrow q_{R\text{-moves}} \\
 \mathbf{Braids} & \xrightarrow{q_{R\text{-moves}}} & \mathbf{Braids}/R\text{-moves}
 \end{array}$$

(9) By definition of  $\mathbf{Braids}/R2_{\text{both}}$ , the following diagram in  $\mathbf{Cat}$  commutes.

$$\begin{array}{ccc}
 \mathcal{I} & \xrightarrow{\sigma_2 \circ \sigma_2^{-1}} & \mathbf{Braids} \\
 id(2) \downarrow & & \downarrow q_{R2_{\text{both}}} \\
 \mathbf{Braids} & \xrightarrow{q_{R2_{\text{both}}}} & \mathbf{Braids}/R2_{\text{both}}
 \end{array}$$

(10) We deduce from (9) that the following diagram in  $\mathbf{Cat}$  commutes.

$$\begin{array}{ccccc}
 \mathcal{I} & \xrightarrow{\sigma_2 \circ \sigma_2^{-1}} & & & \mathbf{Braids} \\
 \downarrow id(2) & & & \swarrow q_{R2_{\text{both}}} & \downarrow q_{R\text{-moves}} \\
 & & \mathbf{Braids}/R2_{\text{both}} & & \\
 & \nearrow q_{R2_{\text{both}}} & & \searrow q_{R3_{\text{one}}} & \\
 \mathbf{Braids} & \xrightarrow{q_{R\text{-moves}}} & & & \mathbf{Braids}/R\text{-moves}
 \end{array}$$

(11) By the functoriality  $q_{R\text{-moves}}$ , we deduce from (10) that the following diagram in  $\mathbf{Cat}$  commutes.

$$\begin{array}{ccc}
 \mathcal{I} & \xrightarrow{\sigma_1^{-1} \circ \sigma_2 \circ \sigma_1 \circ \sigma_2 \circ \sigma_2^{-1}} & \mathbf{Braids} \\
 \sigma_1^{-1} \circ \sigma_2 \circ \sigma_1 \downarrow & & \downarrow q_{R\text{-moves}} \\
 \mathbf{Braids} & \xrightarrow{q_{R\text{-moves}}} & \mathbf{Braids}/R\text{-moves}
 \end{array}$$

(12) We deduce from (8) and (11) that the following diagram in  $\mathbf{Cat}$  commutes, as required.

$$\begin{array}{ccc}
 \mathcal{I} & \xrightarrow{\sigma_2 \circ \sigma_1 \circ \sigma_2^{-1}} & \mathbf{Braids} \\
 \sigma_1^{-1} \circ \sigma_2 \circ \sigma_1 \downarrow & & \downarrow q_{\mathbf{R}\text{-moves}} \\
 \mathbf{Braids} & \xrightarrow{q_{\mathbf{R}\text{-moves}}} & \mathbf{Braids}/\mathbf{R}\text{-moves}
 \end{array}$$

□

**Remark 3.1.2.23.** In our pictorial notation, the proof of Proposition 3.1.2.22 is as follows.

(1) By definition of  $\mathbf{Braids}/\mathbf{R}\text{-moves}$ , the braid

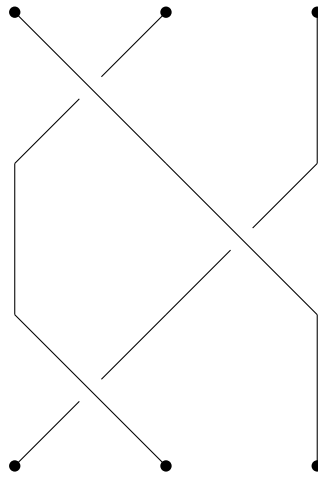

is equal, as an arrow of  $\mathbf{Braids}/\mathbf{R}\text{-moves}$ , to the following braid.

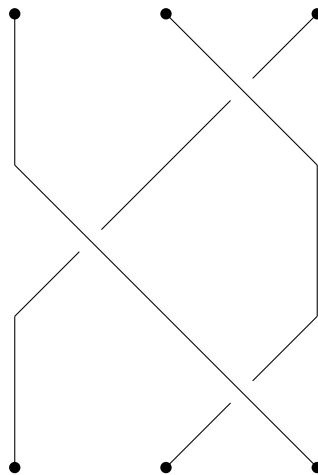

(2) By functoriality of  $q_{R\text{-moves}}$ , the braid

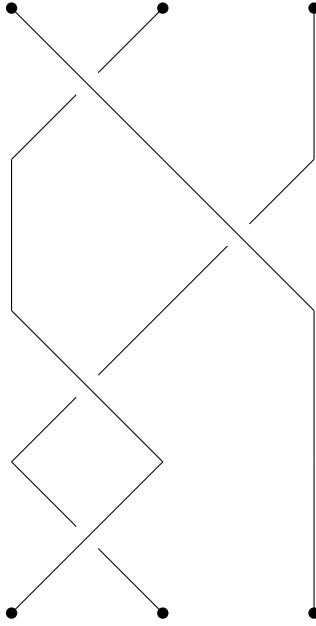

is equal, as an arrow of  $\text{Braids}/R\text{-moves}$ , to the following braid.

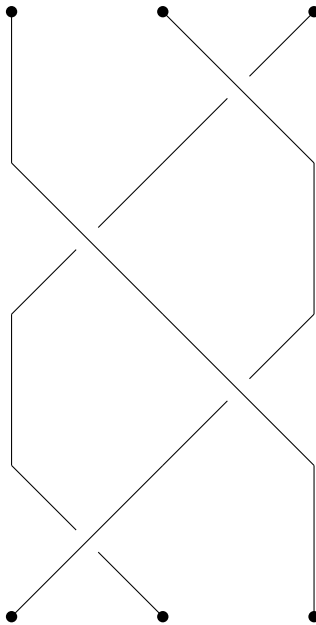

(3) By definition of  $\text{Braids}/R2_{\text{one}}$ , the braid

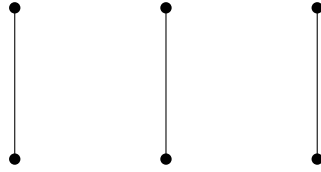

is equal, as an arrow of  $\text{Braids}/R2_{\text{one}}$ , to the following braid.

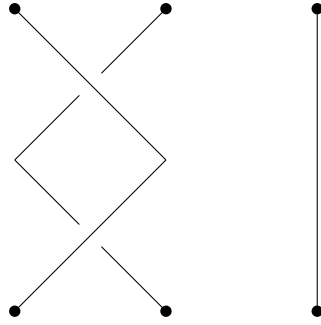

(4) We deduce from (3) that the braid

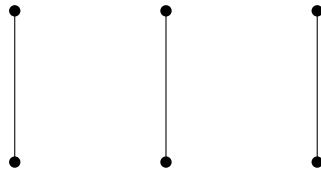

is equal, as an arrow of  $\text{Braids}/R2_{\text{both}}$ , to the following braid.

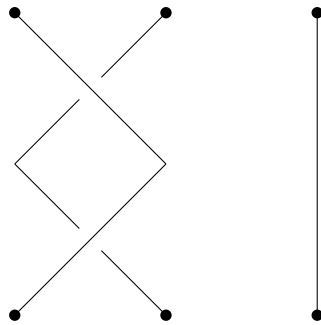

(5) We deduce from (4) that the braid

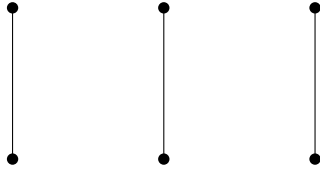

is equal, as an arrow of Braids/R-moves, to the following braid.

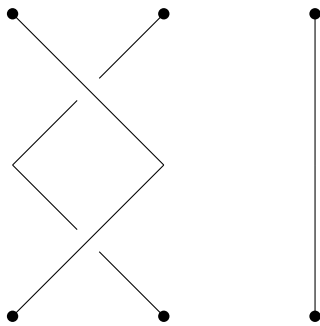

(6) By functoriality of  $q_{R\text{-moves}}$ , we deduce from (5) that the braid

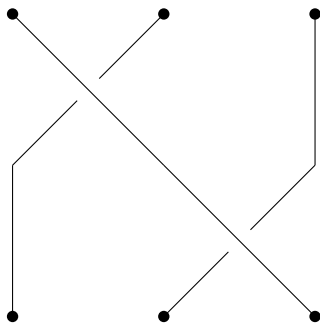

is equal, as an arrow of Braids/R-moves, to the following braid.



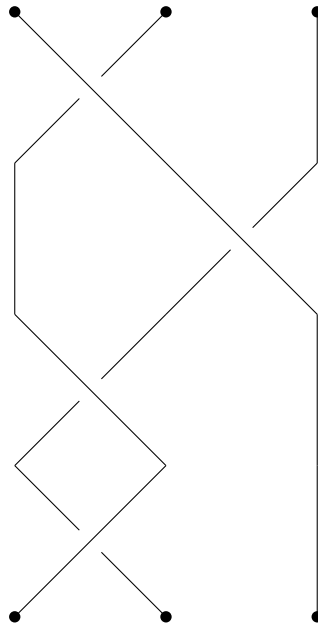

(7) We deduce from (2) and (6) that the braid

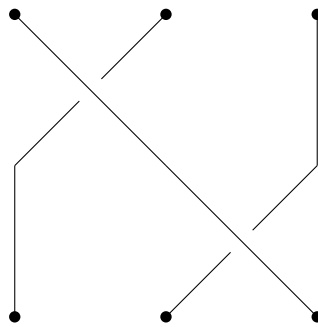

is equal, as an arrow of Braids/R-moves, to the following braid.

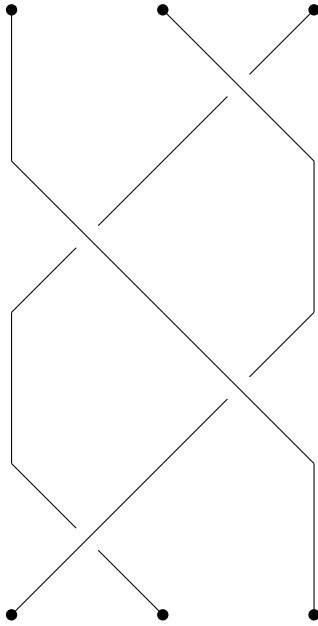

(8) By functoriality of  $q_{R\text{-moves}}$ , we deduce from (7) that the braid

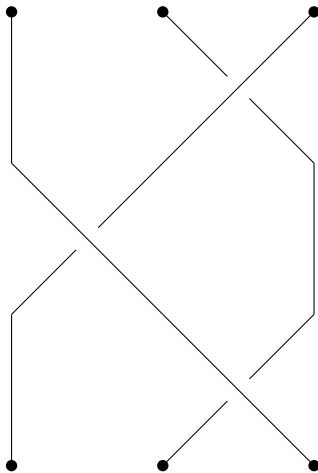

is equal, as an arrow of  $\text{Braids}/R\text{-moves}$ , to the following braid.

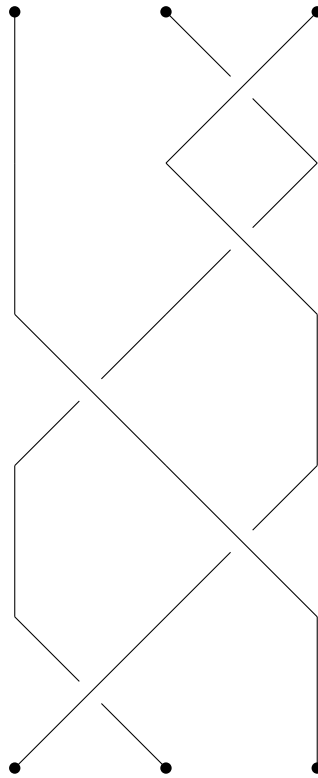

(9) By definition of  $\text{Braids}/R2_{\text{both}}$ , the braid

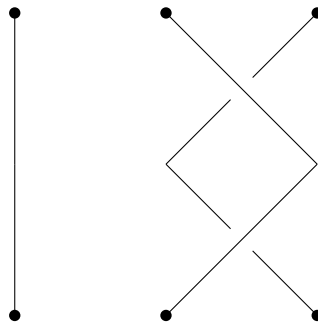

is equal, as an arrow of  $\text{Braids}/R2_{\text{both}}$ , to the following braid.

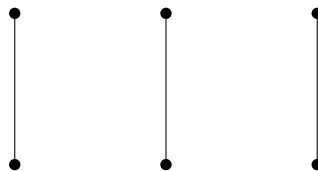

(10) We deduce from (10) that the braid

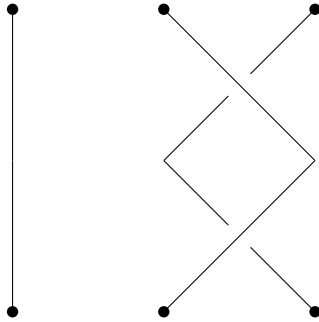

is equal, as an arrow of Braids/R-moves, to the following braid.

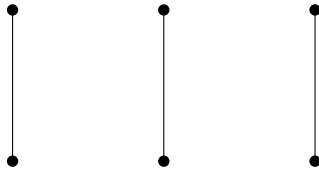

(11) By functoriality of  $q_{R\text{-moves}}$ , we deduce from (10) that the braid

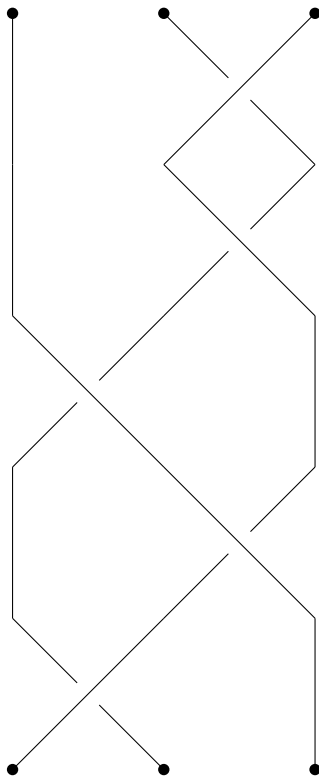

is equal, as an arrow of Braids/R-moves, to the following braid.

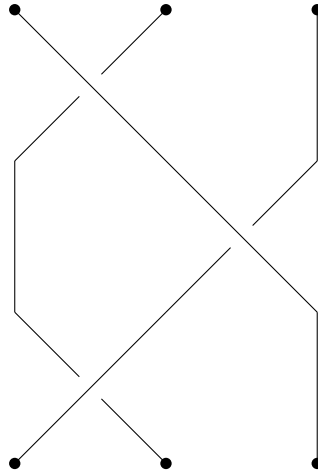

(12) We deduce from (8) and (11) that the braid

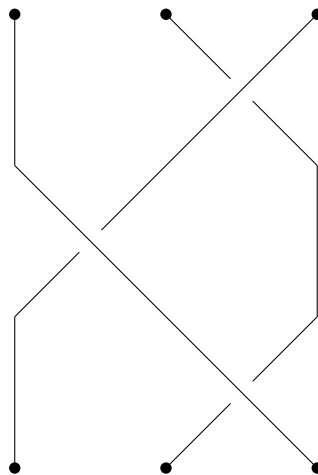

is equal, as an arrow of Braids/R-moves, to the following braid.



(3) We deduce from (2) that the following diagram in  $\text{Cat}$  commutes.

$$\begin{array}{ccc}
 \mathcal{I} & \xrightarrow{i_{\mathcal{I}}} & F(\mathcal{I}) \\
 & \searrow & \downarrow q_{\text{R-moves}} \circ \text{R3}_{\text{two}}(\text{one half}) \\
 & & \text{Braids/R-moves}
 \end{array}$$

$q_{\text{R-moves}} \circ (\sigma_2 \circ \sigma_1 \circ \sigma_2^{-1})$

(4) By definition of  $\text{R3}_{\text{two}}(\text{second half})$ , the following diagram in  $\text{Cat}$  commutes.

$$\begin{array}{ccc}
 \mathcal{I} & \xrightarrow{i_{\mathcal{I}}} & F(\mathcal{I}) \\
 & \searrow & \downarrow \text{R3}_{\text{two}}(\text{other half}) \\
 & & \text{Braids/R-moves}
 \end{array}$$

$\sigma_2 \circ \sigma_1 \circ \sigma_2^{-1}$

(5) We deduce from (4) that the following diagram in  $\text{Cat}$  commutes.

$$\begin{array}{ccc}
 \mathcal{I} & \xrightarrow{i_{\mathcal{I}}} & F(\mathcal{I}) \\
 & \searrow & \downarrow q_{\text{R-moves}} \circ \text{R3}_{\text{two}}(\text{other half}) \\
 & & \text{Braids/R-moves}
 \end{array}$$

$q_{\text{R-moves}} \circ (\sigma_2 \circ \sigma_1 \circ \sigma_2^{-1})$

(6) Appealing to the universal property of  $F(\mathcal{I})$ , we deduce from (3) and (5) that the following diagram in  $\text{Cat}$  commutes, as required.

$$\begin{array}{ccc}
 F(\mathcal{I}) & \xrightarrow{\text{R3}_{\text{two}}(\text{one half})} & \text{Braids} \\
 \downarrow \text{R3}_{\text{two}}(\text{other half}) & & \downarrow q_{\text{R-moves}} \\
 \text{Braids} & \xrightarrow{q_{\text{R-moves}}} & \text{Braids/R-moves}
 \end{array}$$

□

**Notation 3.1.2.25.** Let

$$F(\mathcal{I}) \xrightarrow{\text{R3}_{\text{three}}(\text{one half})} \text{Braids}$$

be the strict monoidal functor to which, by means of the universal property of  $F(\mathcal{I})$ , the functor

$$\mathcal{I} \xrightarrow{\sigma_1 \circ \sigma_2 \circ \sigma_1^{-1}} \text{Braids}$$

gives rise.

**Notation 3.1.2.26.** Let

$$F(\mathcal{I}) \xrightarrow{\text{R3}_{\text{three}}(\text{other half})} \text{Braids}$$

be the strict monoidal functor to which, by means of the universal property of  $F(\mathcal{I})$ , the functor

$$\mathcal{I} \xrightarrow{\sigma_2^{-1} \circ \sigma_1 \circ \sigma_2} \text{Braids}$$

gives rise.

**Remark 3.1.2.27.** The arrows  $\text{R3}_{\text{three}}(\text{one half})$  and  $\text{R3}_{\text{three}}(\text{other half})$  of Braids express algebraically the two halves of the R3 move which allows us to replace

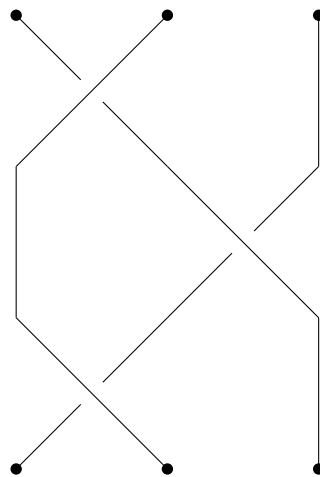

by the following, and vice versa.



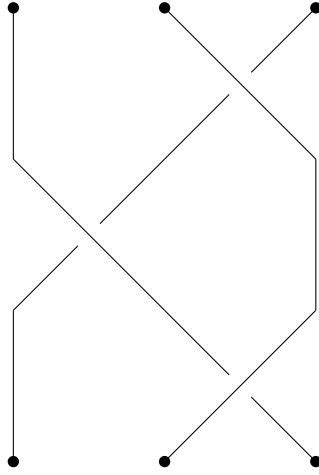

We refer to this R3 move as  $R3_{\text{three}}$ .

**Proposition 3.1.2.28.** *The following diagram in  $\text{Cat}$  commutes.*

$$\begin{array}{ccc}
 \mathcal{I} & \xrightarrow{\sigma_1 \circ \sigma_2 \circ \sigma_1^{-1}} & \text{Braids} \\
 \sigma_2^{-1} \circ \sigma_1 \circ \sigma_2 \downarrow & & \downarrow q_{\text{R-moves}} \\
 \text{Braids} & \xrightarrow{q_{\text{R-moves}}} & \text{Braids/R-moves}
 \end{array}$$

*Proof.* We make the following observations.

(1) By definition of Braids/R-moves, the following diagram in  $\text{Cat}$  commutes.

$$\begin{array}{ccc}
 \mathcal{I} & \xrightarrow{\sigma_1 \circ \sigma_2 \circ \sigma_1} & \text{Braids} \\
 \sigma_2 \circ \sigma_1 \circ \sigma_2 \downarrow & & \downarrow q_{\text{R-moves}} \\
 \text{Braids} & \xrightarrow{q_{\text{R-moves}}} & \text{Braids/R-moves}
 \end{array}$$

(2) By the functoriality of  $q_{\text{R-moves}}$ , we deduce from (1) that the following diagram in  $\text{Cat}$  commutes.

$$\begin{array}{ccc}
 \mathcal{I} & \xrightarrow{\sigma_1 \circ \sigma_2 \circ \sigma_1 \circ \sigma_1^{-1}} & \text{Braids} \\
 \sigma_2 \circ \sigma_1 \circ \sigma_2 \circ \sigma_1^{-1} \downarrow & & \downarrow q_{\text{R-moves}} \\
 \text{Braids} & \xrightarrow{q_{\text{R-moves}}} & \text{Braids/R-moves}
 \end{array}$$

(3) By definition of  $\text{Braids}/R2_{\text{one}}$ , the following diagram in  $\text{Cat}$  commutes.

$$\begin{array}{ccc}
 \mathcal{I} & \xrightarrow{id(2)} & \text{Braids} \\
 \sigma_1 \circ \sigma_1^{-1} \downarrow & & \downarrow qR2_{\text{both}} \\
 \text{Braids} & \xrightarrow{qR2_{\text{both}}} & \text{Braids}/R2_{\text{both}}
 \end{array}$$

(4) We deduce from (3) that the following diagram in  $\text{Cat}$  commutes.

$$\begin{array}{ccccc}
 \mathcal{I} & \xrightarrow{id(2)} & & & \text{Braids} \\
 \downarrow \sigma_1 \circ \sigma_1^{-1} & & & & \downarrow qR2_{\text{both}} \\
 & & \text{Braids}/R2_{\text{one}} & & \\
 & \nearrow qR2_{\text{one}} & & \searrow qR2_{\text{two}} & \\
 \text{Braids} & \xrightarrow{qR2_{\text{both}}} & & & \text{Braids}/R2_{\text{both}}
 \end{array}$$

(5) We deduce from (4) that the following diagram in  $\text{Cat}$  commutes.

$$\begin{array}{ccccc}
 \mathcal{I} & \xrightarrow{id(2)} & & & \text{Braids} \\
 \downarrow \sigma_1 \circ \sigma_1^{-1} & & & & \downarrow qR\text{-moves} \\
 & & \text{Braids}/R2_{\text{both}} & & \\
 & \nearrow qR2_{\text{both}} & & \searrow qR3_{\text{one}} & \\
 \text{Braids} & \xrightarrow{qR\text{-moves}} & & & \text{Braids}/R\text{-moves}
 \end{array}$$

(6) By the functoriality  $qR\text{-moves}$ , we deduce from (5) that the following diagram in  $\text{Cat}$  commutes.

$$\begin{array}{ccc}
 \mathcal{I} & \xrightarrow{\sigma_1 \circ \sigma_2} & \text{Braids} \\
 \sigma_1 \circ \sigma_2 \circ \sigma_1 \circ \sigma_1^{-1} \downarrow & & \downarrow qR\text{-moves} \\
 \text{Braids} & \xrightarrow{qR\text{-moves}} & \text{Braids}/R\text{-moves}
 \end{array}$$

(7) We deduce from (2) and (6) that the following diagram in  $\text{Cat}$  commutes.

$$\begin{array}{ccc}
 \mathcal{I} & \xrightarrow{\sigma_1 \circ \sigma_2} & \text{Braids} \\
 \sigma_2 \circ \sigma_1 \circ \sigma_2 \circ \sigma_1^{-1} \downarrow & & \downarrow q_{\text{R-moves}} \\
 \text{Braids} & \xrightarrow{q_{\text{R-moves}}} & \text{Braids/R-moves}
 \end{array}$$

(8) By the functoriality  $q_{\text{R-moves}}$ , we deduce from (7) that the following diagram in  $\text{Cat}$  commutes.

$$\begin{array}{ccc}
 \mathcal{I} & \xrightarrow{\sigma_2^{-1} \circ \sigma_1 \circ \sigma_2} & \text{Braids} \\
 \sigma_2^{-1} \circ \sigma_2 \circ \sigma_1 \circ \sigma_2 \circ \sigma_1^{-1} \downarrow & & \downarrow q_{\text{R-moves}} \\
 \text{Braids} & \xrightarrow{q_{\text{R-moves}}} & \text{Braids/R-moves}
 \end{array}$$

(9) By definition of  $\text{Braids/R2}_{\text{both}}$ , the following diagram in  $\text{Cat}$  commutes.

$$\begin{array}{ccc}
 \mathcal{I} & \xrightarrow{\sigma_2^{-1} \circ \sigma_2} & \text{Braids} \\
 id(3) \downarrow & & \downarrow q_{\text{R2}_{\text{both}}} \\
 \text{Braids} & \xrightarrow{q_{\text{R2}_{\text{both}}}} & \text{Braids/R2}_{\text{both}}
 \end{array}$$

(10) We deduce from (9) that the following diagram in  $\text{Cat}$  commutes.

$$\begin{array}{ccccc}
 \mathcal{I} & \xrightarrow{\sigma_2^{-1} \circ \sigma_2} & & & \text{Braids} \\
 \downarrow id(3) & & & & \downarrow q_{\text{R-moves}} \\
 & & \text{Braids/R2}_{\text{both}} & & \\
 & \nearrow q_{\text{R2}_{\text{both}}} & & \searrow q_{\text{R3}_{\text{one}}} & \\
 \text{Braids} & \xrightarrow{q_{\text{R-moves}}} & & & \text{Braids/R-moves}
 \end{array}$$

(11) By the functoriality  $q_{\text{R-moves}}$ , we deduce from (10) that the following diagram in  $\text{Cat}$  commutes.

$$\begin{array}{ccc}
\mathcal{I} & \xrightarrow{\sigma_2^{-1} \circ \sigma_2 \circ \sigma_1 \circ \sigma_2 \circ \sigma_1^{-1}} & \text{Braids} \\
\sigma_1 \circ \sigma_2 \circ \sigma_1^{-1} \downarrow & & \downarrow q_{\text{R-moves}} \\
\text{Braids} & \xrightarrow{q_{\text{R-moves}}} & \text{Braids/R-moves}
\end{array}$$

(12) We deduce from (8) and (11) that the following diagram in  $\text{Cat}$  commutes, as required.

$$\begin{array}{ccc}
\mathcal{I} & \xrightarrow{\sigma_2^{-1} \circ \sigma_1 \circ \sigma_2} & \text{Braids} \\
\sigma_1 \circ \sigma_2 \circ \sigma_1^{-1} \downarrow & & \downarrow q_{\text{R-moves}} \\
\text{Braids} & \xrightarrow{q_{\text{R-moves}}} & \text{Braids/R-moves}
\end{array}$$

□

**Corollary 3.1.2.29.** *The following diagram in  $\text{Cat}$  commutes.*

$$\begin{array}{ccc}
F(\mathcal{I}) & \xrightarrow{\text{R3}_{\text{three}}(\text{one half})} & \text{Braids} \\
\text{R3}_{\text{three}}(\text{other half}) \downarrow & & \downarrow q_{\text{R-moves}} \\
\text{Braids} & \xrightarrow{q_{\text{R-moves}}} & \text{Braids/R-moves}
\end{array}$$

*Proof.* We make the following observations.

(1) By definition of  $\text{R3}_{\text{three}}(\text{one half})$ , the following diagram in  $\text{Cat}$  commutes.

$$\begin{array}{ccc}
\mathcal{I} & \xrightarrow{i_{\mathcal{I}}} & F(\mathcal{I}) \\
\sigma_1 \circ \sigma_2 \circ \sigma_1^{-1} \searrow & & \downarrow \text{R3}_{\text{three}}(\text{one half}) \\
& & \text{Braids/R-moves}
\end{array}$$

(2) We deduce from (1) and Proposition 3.1.2.28 that the following diagram in  $\text{Cat}$  commutes.

$$\begin{array}{ccc}
\mathcal{I} & \xrightarrow{i_{\mathcal{I}}} & F(\mathcal{I}) \\
& \searrow^{\sigma_2^{-1} \circ \sigma_1 \circ \sigma_2} & \downarrow R3_{\text{three}}(\text{one half}) \\
& & \text{Braids/R-moves}
\end{array}$$

(3) We deduce from (2) that the following diagram in  $\text{Cat}$  commutes.

$$\begin{array}{ccc}
\mathcal{I} & \xrightarrow{i_{\mathcal{I}}} & F(\mathcal{I}) \\
& \searrow^{q_{\text{R-moves}} \circ (\sigma_2^{-1} \circ \sigma_1 \circ \sigma_2)} & \downarrow q_{\text{R-moves}} \circ R3_{\text{three}}(\text{one half}) \\
& & \text{Braids/R-moves}
\end{array}$$

(4) By definition of  $R3_{\text{three}}(\text{other half})$ , the following diagram in  $\text{Cat}$  commutes.

$$\begin{array}{ccc}
\mathcal{I} & \xrightarrow{i_{\mathcal{I}}} & F(\mathcal{I}) \\
& \searrow^{\sigma_2^{-1} \circ \sigma_1 \circ \sigma_2} & \downarrow R3_{\text{three}}(\text{other half}) \\
& & \text{Braids/R-moves}
\end{array}$$

(5) We deduce from (4) that the following diagram in  $\text{Cat}$  commutes.

$$\begin{array}{ccc}
\mathcal{I} & \xrightarrow{i_{\mathcal{I}}} & F(\mathcal{I}) \\
& \searrow^{q_{\text{R-moves}} \circ (\sigma_2^{-1} \circ \sigma_1 \circ \sigma_2)} & \downarrow q_{\text{R-moves}} \circ R3_{\text{three}}(\text{other half}) \\
& & \text{Braids/R-moves}
\end{array}$$

(6) Appealing to the universal property of  $F(\mathcal{I})$ , we deduce from (3) and (5) that the following diagram in  $\text{Cat}$  commutes, as required.

$$\begin{array}{ccc}
F(\mathcal{I}) & \xrightarrow{R3_{\text{three}}(\text{one half})} & \text{Braids} \\
R3_{\text{three}}(\text{other half}) \downarrow & & \downarrow q_{\text{R-moves}} \\
\text{Braids} & \xrightarrow{q_{\text{R-moves}}} & \text{Braids/R-moves}
\end{array}$$

□

**Notation 3.1.2.30.** Let

$$F(\mathcal{I}) \xrightarrow{R3_{\text{four}}(\text{one half})} \text{Braids}$$

be the strict monoidal functor to which, by means of the universal property of  $F(\mathcal{I})$ , the functor

$$\mathcal{I} \xrightarrow{\sigma_1 \circ \sigma_2^{-1} \circ \sigma_1^{-1}} \text{Braids}$$

gives rise.

**Notation 3.1.2.31.** Let

$$F(\mathcal{I}) \xrightarrow{R3_{\text{four}}(\text{other half})} \text{Braids}$$

be the strict monoidal functor to which, by means of the universal property of  $F(\mathcal{I})$ , the functor

$$\mathcal{I} \xrightarrow{\sigma_2^{-1} \circ \sigma_1^{-1} \circ \sigma_2} \text{Braids}$$

gives rise.

**Remark 3.1.2.32.** The arrows  $R3_{\text{four}}(\text{one half})$  and  $R3_{\text{four}}(\text{other half})$  of Braids express algebraically the two halves of the R3 move which allows us to replace

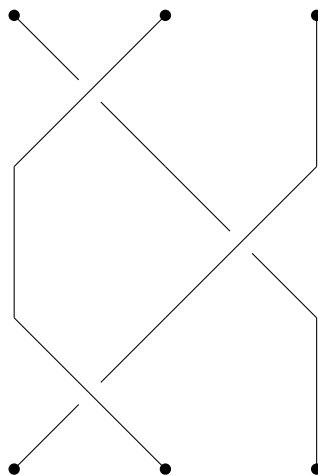

by the following, and vice versa.

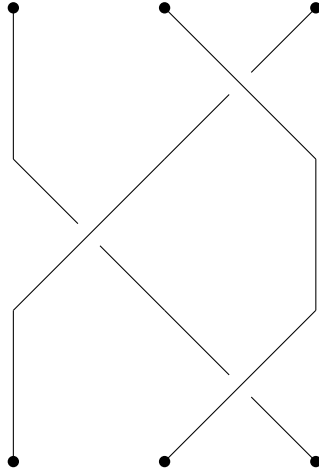

We refer to this R3 move as  $R3_{\text{four}}$ .

**Proposition 3.1.2.33.** *The following diagram in  $\text{Cat}$  commutes.*

$$\begin{array}{ccc}
 \mathcal{I} & \xrightarrow{\sigma_1 \circ \sigma_2^{-1} \circ \sigma_1^{-1}} & \text{Braids} \\
 \downarrow \sigma_2^{-1} \circ \sigma_1^{-1} \circ \sigma_2 & & \downarrow q_{\text{R-moves}} \\
 \text{Braids} & \xrightarrow{q_{\text{R-moves}}} & \text{Braids/R-moves}
 \end{array}$$

*Proof.* We make the following observations.

(1) By Proposition 3.1.2.22 the following diagram in  $\text{Cat}$  commutes.

$$\begin{array}{ccc}
 \mathcal{I} & \xrightarrow{\sigma_1^{-1} \circ \sigma_2 \circ \sigma_1} & \text{Braids} \\
 \downarrow \sigma_2 \circ \sigma_1 \circ \sigma_2^{-1} & & \downarrow q_{\text{R-moves}} \\
 \text{Braids} & \xrightarrow{q_{\text{R-moves}}} & \text{Braids/R-moves}
 \end{array}$$

(2) By the functoriality of  $q_{\text{R-moves}}$ , we deduce from (1) that the following diagram in  $\text{Cat}$  commutes.

$$\begin{array}{ccc}
 \mathcal{I} & \xrightarrow{\sigma_1^{-1} \circ \sigma_2 \circ \sigma_1 \circ \sigma_1^{-1}} & \text{Braids} \\
 \downarrow \sigma_2 \circ \sigma_1 \circ \sigma_2^{-1} \circ \sigma_1^{-1} & & \downarrow q_{\text{R-moves}} \\
 \text{Braids} & \xrightarrow{q_{\text{R-moves}}} & \text{Braids/R-moves}
 \end{array}$$

(3) By definition of  $\text{Braids}/R2_{\text{one}}$ , the following diagram in  $\text{Cat}$  commutes.

$$\begin{array}{ccc}
 \mathcal{I} & \xrightarrow{id(3)} & \text{Braids} \\
 \sigma_1 \circ \sigma_1^{-1} \downarrow & & \downarrow q_{R2_{\text{both}}} \\
 \text{Braids} & \xrightarrow{q_{R2_{\text{both}}}} & \text{Braids}/R2_{\text{both}}
 \end{array}$$

(4) We deduce from (3) that the following diagram in  $\text{Cat}$  commutes.

$$\begin{array}{ccccc}
 \mathcal{I} & & \xrightarrow{id(3)} & & \text{Braids} \\
 \downarrow \sigma_1 \circ \sigma_1^{-1} & & & \swarrow q_{R2_{\text{one}}} & \downarrow q_{R2_{\text{both}}} \\
 & & \text{Braids}/R2_{\text{one}} & & \\
 & \swarrow q_{R2_{\text{one}}} & & \searrow q_{R2_{\text{two}}} & \\
 \text{Braids} & & \xrightarrow{q_{R2_{\text{both}}}} & & \text{Braids}/R2_{\text{both}}
 \end{array}$$

(5) We deduce from (4) that the following diagram in  $\text{Cat}$  commutes.

$$\begin{array}{ccccc}
 \mathcal{I} & & \xrightarrow{id(3)} & & \text{Braids} \\
 \downarrow \sigma_1 \circ \sigma_1^{-1} & & & \swarrow q_{R2_{\text{both}}} & \downarrow q_{R\text{-moves}} \\
 & & \text{Braids}/R2_{\text{both}} & & \\
 & \swarrow q_{R2_{\text{both}}} & & \searrow q_{R3_{\text{one}}} & \\
 \text{Braids} & & \xrightarrow{q_{R\text{-moves}}} & & \text{Braids}/R\text{-moves}
 \end{array}$$

(6) By the functoriality  $q_{R\text{-moves}}$ , we deduce from (5) that the following diagram in  $\text{Cat}$  commutes.

$$\begin{array}{ccc}
 \mathcal{I} & \xrightarrow{\sigma_1^{-1} \circ \sigma_2} & \text{Braids} \\
 \sigma_1^{-1} \circ \sigma_2 \circ \sigma_1 \circ \sigma_1^{-1} \downarrow & & \downarrow q_{R\text{-moves}} \\
 \text{Braids} & \xrightarrow{q_{R\text{-moves}}} & \text{Braids}/R\text{-moves}
 \end{array}$$



(7) We deduce from (2) and (6) that the following diagram in  $\mathbf{Cat}$  commutes.

$$\begin{array}{ccc}
 \mathcal{I} & \xrightarrow{\sigma_1^{-1} \circ \sigma_2} & \mathbf{Braids} \\
 \sigma_2 \circ \sigma_1 \circ \sigma_2^{-1} \circ \sigma_1^{-1} \downarrow & & \downarrow q_{\mathbf{R}\text{-moves}} \\
 \mathbf{Braids} & \xrightarrow{q_{\mathbf{R}\text{-moves}}} & \mathbf{Braids}/\mathbf{R}\text{-moves}
 \end{array}$$

(8) By the functoriality  $q_{\mathbf{R}\text{-moves}}$ , we deduce from (7) that the following diagram in  $\mathbf{Cat}$  commutes.

$$\begin{array}{ccc}
 \mathcal{I} & \xrightarrow{\sigma_2^{-1} \circ \sigma_1^{-1} \circ \sigma_2} & \mathbf{Braids} \\
 \sigma_2^{-1} \circ \sigma_2 \circ \sigma_1^{-1} \circ \sigma_2 \circ \sigma_1^{-1} \downarrow & & \downarrow q_{\mathbf{R}\text{-moves}} \\
 \mathbf{Braids} & \xrightarrow{q_{\mathbf{R}\text{-moves}}} & \mathbf{Braids}/\mathbf{R}\text{-moves}
 \end{array}$$

(9) By definition of  $\mathbf{Braids}/\mathbf{R2}_{\text{both}}$ , the following diagram in  $\mathbf{Cat}$  commutes.

$$\begin{array}{ccc}
 \mathcal{I} & \xrightarrow{\sigma_2^{-1} \circ \sigma_2} & \mathbf{Braids} \\
 id(3) \downarrow & & \downarrow q_{\mathbf{R2}_{\text{both}}} \\
 \mathbf{Braids} & \xrightarrow{q_{\mathbf{R2}_{\text{both}}}} & \mathbf{Braids}/\mathbf{R2}_{\text{both}}
 \end{array}$$

(10) We deduce from (9) that the following diagram in  $\mathbf{Cat}$  commutes.

$$\begin{array}{ccccc}
 \mathcal{I} & \xrightarrow{\sigma_2^{-1} \circ \sigma_2} & & & \mathbf{Braids} \\
 \downarrow id(3) & & & & \downarrow q_{\mathbf{R}\text{-moves}} \\
 & & \mathbf{Braids}/\mathbf{R2}_{\text{both}} & & \\
 & \nearrow q_{\mathbf{R2}_{\text{both}}} & & \searrow q_{\mathbf{R3}_{\text{one}}} & \\
 \mathbf{Braids} & \xrightarrow{q_{\mathbf{R}\text{-moves}}} & & & \mathbf{Braids}/\mathbf{R}\text{-moves}
 \end{array}$$

(11) By the functoriality  $q_{\mathbf{R}\text{-moves}}$ , we deduce from (10) that the following diagram in  $\mathbf{Cat}$  commutes.

$$\begin{array}{ccc}
\mathcal{I} & \xrightarrow{\sigma_2^{-1} \circ \sigma_2 \circ \sigma_1 \circ \sigma_2^{-1} \circ \sigma_1^{-1}} & \text{Braids} \\
\sigma_1 \circ \sigma_2^{-1} \circ \sigma_1^{-1} \downarrow & & \downarrow q_{\text{R-moves}} \\
\text{Braids} & \xrightarrow{q_{\text{R-moves}}} & \text{Braids/R-moves}
\end{array}$$

(12) We deduce from (8) and (11) that the following diagram in  $\text{Cat}$  commutes, as required.

$$\begin{array}{ccc}
\mathcal{I} & \xrightarrow{\sigma_2^{-1} \circ \sigma_1^{-1} \circ \sigma_2} & \text{Braids} \\
\sigma_1 \circ \sigma_2^{-1} \circ \sigma_1^{-1} \downarrow & & \downarrow q_{\text{R-moves}} \\
\text{Braids} & \xrightarrow{q_{\text{R-moves}}} & \text{Braids/R-moves}
\end{array}$$

□

**Corollary 3.1.2.34.** *The following diagram in  $\text{Cat}$  commutes.*

$$\begin{array}{ccc}
F(\mathcal{I}) & \xrightarrow{\text{R3}_{\text{four}}(\text{one half})} & \text{Braids} \\
\text{R3}_{\text{four}}(\text{other half}) \downarrow & & \downarrow q_{\text{R-moves}} \\
\text{Braids} & \xrightarrow{q_{\text{R-moves}}} & \text{Braids/R-moves}
\end{array}$$

*Proof.* We make the following observations.

(1) By definition of  $\text{R3}_{\text{four}}(\text{one half})$ , the following diagram in  $\text{Cat}$  commutes.

$$\begin{array}{ccc}
\mathcal{I} & \xrightarrow{i_{\mathcal{I}}} & F(\mathcal{I}) \\
\sigma_1 \circ \sigma_2^{-1} \circ \sigma_1^{-1} \searrow & & \downarrow \text{R3}_{\text{four}}(\text{one half}) \\
& & \text{Braids/R-moves}
\end{array}$$

(2) We deduce from (1) and Proposition 3.1.2.33 that the following diagram in  $\text{Cat}$  commutes.

$$\begin{array}{ccc}
\mathcal{I} & \xrightarrow{i_{\mathcal{I}}} & F(\mathcal{I}) \\
& \searrow & \downarrow \text{R3}_{\text{four}}(\text{one half}) \\
& & \text{Braids/R-moves}
\end{array}$$

$\sigma_2^{-1} \circ \sigma_1^{-1} \circ \sigma_2$

(3) We deduce from (2) that the following diagram in  $\text{Cat}$  commutes.

$$\begin{array}{ccc}
\mathcal{I} & \xrightarrow{i_{\mathcal{I}}} & F(\mathcal{I}) \\
& \searrow & \downarrow q_{\text{R-moves}} \circ \text{R3}_{\text{four}}(\text{one half}) \\
& & \text{Braids/R-moves}
\end{array}$$

$q_{\text{R-moves}} \circ (\sigma_2^{-1} \circ \sigma_1^{-1} \circ \sigma_2)$

(4) By definition of  $\text{R3}_{\text{four}}(\text{other half})$ , the following diagram in  $\text{Cat}$  commutes.

$$\begin{array}{ccc}
\mathcal{I} & \xrightarrow{i_{\mathcal{I}}} & F(\mathcal{I}) \\
& \searrow & \downarrow \text{R3}_{\text{four}}(\text{other half}) \\
& & \text{Braids/R-moves}
\end{array}$$

$\sigma_2^{-1} \circ \sigma_1^{-1} \circ \sigma_2$

(5) We deduce from (4) that the following diagram in  $\text{Cat}$  commutes.

$$\begin{array}{ccc}
\mathcal{I} & \xrightarrow{i_{\mathcal{I}}} & F(\mathcal{I}) \\
& \searrow & \downarrow q_{\text{R-moves}} \circ \text{R3}_{\text{four}}(\text{other half}) \\
& & \text{Braids/R-moves}
\end{array}$$

$q_{\text{R-moves}} \circ (\sigma_2^{-1} \circ \sigma_1^{-1} \circ \sigma_2)$

(6) Appealing to the universal property of  $F(\mathcal{I})$ , we deduce from (3) and (5) that the following diagram in  $\text{Cat}$  commutes, as required.

$$\begin{array}{ccc}
F(\mathcal{I}) & \xrightarrow{\text{R3}_{\text{four}}(\text{one half})} & \text{Braids} \\
\downarrow \text{R3}_{\text{four}}(\text{other half}) & & \downarrow q_{\text{R-moves}} \\
\text{Braids} & \xrightarrow{q_{\text{R-moves}}} & \text{Braids/R-moves}
\end{array}$$

□

**Notation 3.1.2.35.** Let

$$F(\mathcal{I}) \xrightarrow{\text{R3}_{\text{five}}(\text{one half})} \text{Braids}$$

be the strict monoidal functor to which, by means of the universal property of  $F(\mathcal{I})$ , the functor

$$\mathcal{I} \xrightarrow{\sigma_1^{-1} \circ \sigma_2^{-1} \circ \sigma_1} \text{Braids}$$

gives rise.

**Notation 3.1.2.36.** Let

$$F(\mathcal{I}) \xrightarrow{\text{R3}_{\text{five}}(\text{other half})} \text{Braids}$$

be the strict monoidal functor to which, by means of the universal property of  $F(\mathcal{I})$ , the functor

$$\mathcal{I} \xrightarrow{\sigma_2 \circ \sigma_1^{-1} \circ \sigma_2^{-1}} \text{Braids}$$

gives rise.

**Remark 3.1.2.37.** The arrows  $\text{R3}_{\text{five}}(\text{one half})$  and  $\text{R3}_{\text{five}}(\text{other half})$  of  $\text{Braids}$  express algebraically the two halves of the R3 move which allows us to replace

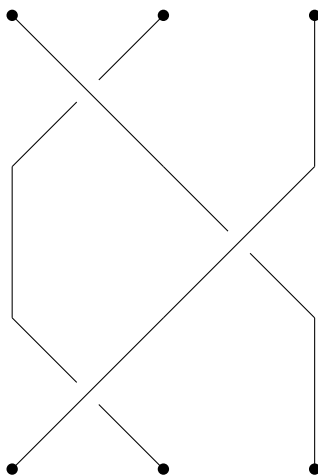

by the following, and vice versa.

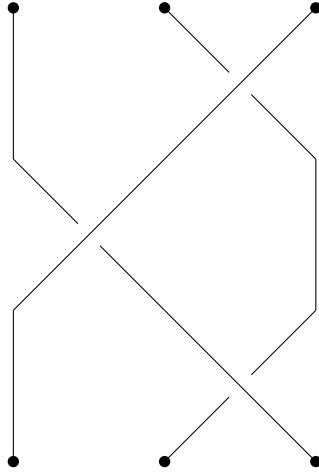

We refer to this R3 move as  $R3_{\text{five}}$ .

**Proposition 3.1.2.38.** *The following diagram in  $\text{Cat}$  commutes.*

$$\begin{array}{ccc}
 \mathcal{I} & \xrightarrow{\sigma_1^{-1} \circ \sigma_2^{-1} \circ \sigma_1} & \text{Braids} \\
 \downarrow \sigma_2 \circ \sigma_1^{-1} \circ \sigma_2^{-1} & & \downarrow q_{\text{R-moves}} \\
 \text{Braids} & \xrightarrow{q_{\text{R-moves}}} & \text{Braids/R-moves}
 \end{array}$$

*Proof.* We make the following observations.

(1) By Proposition 3.1.2.28 the following diagram in  $\text{Cat}$  commutes.

$$\begin{array}{ccc}
 \mathcal{I} & \xrightarrow{\sigma_1 \circ \sigma_2 \circ \sigma_1^{-1}} & \text{Braids} \\
 \downarrow \sigma_2^{-1} \circ \sigma_1 \circ \sigma_2 & & \downarrow q_{\text{R-moves}} \\
 \text{Braids} & \xrightarrow{q_{\text{R-moves}}} & \text{Braids/R-moves}
 \end{array}$$

(2) By the functoriality of  $q_{\text{R-moves}}$ , we deduce from (1) that the following diagram in  $\text{Cat}$  commutes.

$$\begin{array}{ccc}
 \mathcal{I} & \xrightarrow{\sigma_1^{-1} \circ \sigma_1 \circ \sigma_2 \circ \sigma_1^{-1}} & \text{Braids} \\
 \downarrow \sigma_1^{-1} \circ \sigma_2^{-1} \circ \sigma_1 \circ \sigma_2 & & \downarrow q_{\text{R-moves}} \\
 \text{Braids} & \xrightarrow{q_{\text{R-moves}}} & \text{Braids/R-moves}
 \end{array}$$

(3) By definition of  $\text{Braids}/R2_{\text{one}}$ , the following diagram in  $\text{Cat}$  commutes.

$$\begin{array}{ccc}
 \mathcal{I} & \xrightarrow{id(3)} & \text{Braids} \\
 \sigma_1^{-1} \circ \sigma_1 \downarrow & & \downarrow q_{R2_{\text{both}}} \\
 \text{Braids} & \xrightarrow{q_{R2_{\text{both}}}} & \text{Braids}/R2_{\text{both}}
 \end{array}$$

(4) We deduce from (3) that the following diagram in  $\text{Cat}$  commutes.

$$\begin{array}{ccccc}
 \mathcal{I} & \xrightarrow{id(3)} & & & \text{Braids} \\
 \sigma_1^{-1} \circ \sigma_1 \downarrow & & & & \downarrow q_{R2_{\text{both}}} \\
 & & \text{Braids}/R2_{\text{one}} & & \\
 & q_{R2_{\text{one}}} \nearrow & & \nwarrow q_{R2_{\text{two}}} & \\
 \text{Braids} & \xrightarrow{q_{R2_{\text{both}}}} & & & \text{Braids}/R2_{\text{both}}
 \end{array}$$

(5) We deduce from (4) that the following diagram in  $\text{Cat}$  commutes.

$$\begin{array}{ccccc}
 \mathcal{I} & \xrightarrow{id(3)} & & & \text{Braids} \\
 \sigma_1^{-1} \circ \sigma_1 \downarrow & & & & \downarrow q_{R\text{-moves}} \\
 & & \text{Braids}/R2_{\text{both}} & & \\
 & q_{R2_{\text{both}}} \nearrow & & \nwarrow q_{R3_{\text{one}}} & \\
 \text{Braids} & \xrightarrow{q_{R\text{-moves}}} & & & \text{Braids}/R\text{-moves}
 \end{array}$$

(6) By the functoriality  $q_{R\text{-moves}}$ , we deduce from (5) that the following diagram in  $\text{Cat}$  commutes.

$$\begin{array}{ccc}
 \mathcal{I} & \xrightarrow{\sigma_2 \circ \sigma_1^{-1}} & \text{Braids} \\
 \sigma_1^{-1} \circ \sigma_1 \circ \sigma_2 \circ \sigma_1^{-1} \downarrow & & \downarrow q_{R\text{-moves}} \\
 \text{Braids} & \xrightarrow{q_{R\text{-moves}}} & \text{Braids}/R\text{-moves}
 \end{array}$$

(7) We deduce from (2) and (6) that the following diagram in  $\mathbf{Cat}$  commutes.

$$\begin{array}{ccc}
 \mathcal{I} & \xrightarrow{\sigma_2 \circ \sigma_1^{-1}} & \mathbf{Braids} \\
 \sigma_1^{-1} \circ \sigma_2^{-1} \circ \sigma_1 \circ \sigma_2 \downarrow & & \downarrow q_{\mathbf{R}\text{-moves}} \\
 \mathbf{Braids} & \xrightarrow{q_{\mathbf{R}\text{-moves}}} & \mathbf{Braids}/\mathbf{R}\text{-moves}
 \end{array}$$

(8) By the functoriality  $q_{\mathbf{R}\text{-moves}}$ , we deduce from (7) that the following diagram in  $\mathbf{Cat}$  commutes.

$$\begin{array}{ccc}
 \mathcal{I} & \xrightarrow{\sigma_2 \circ \sigma_1^{-1} \circ \sigma_2^{-1}} & \mathbf{Braids} \\
 \sigma_1^{-1} \circ \sigma_2^{-1} \circ \sigma_1 \circ \sigma_2 \circ \sigma_2^{-1} \downarrow & & \downarrow q_{\mathbf{R}\text{-moves}} \\
 \mathbf{Braids} & \xrightarrow{q_{\mathbf{R}\text{-moves}}} & \mathbf{Braids}/\mathbf{R}\text{-moves}
 \end{array}$$

(9) By definition of  $\mathbf{Braids}/\mathbf{R2}_{\text{both}}$ , the following diagram in  $\mathbf{Cat}$  commutes.

$$\begin{array}{ccc}
 \mathcal{I} & \xrightarrow{\sigma_2 \circ \sigma_2^{-1}} & \mathbf{Braids} \\
 id(3) \downarrow & & \downarrow q_{\mathbf{R2}_{\text{both}}} \\
 \mathbf{Braids} & \xrightarrow{q_{\mathbf{R2}_{\text{both}}}} & \mathbf{Braids}/\mathbf{R2}_{\text{both}}
 \end{array}$$

(10) We deduce from (9) that the following diagram in  $\mathbf{Cat}$  commutes.

$$\begin{array}{ccccc}
 \mathcal{I} & \xrightarrow{\sigma_2 \circ \sigma_2^{-1}} & & & \mathbf{Braids} \\
 \downarrow id(3) & & & & \downarrow q_{\mathbf{R}\text{-moves}} \\
 & & \mathbf{Braids}/\mathbf{R2}_{\text{both}} & & \\
 & \nearrow q_{\mathbf{R2}_{\text{both}}} & & \searrow q_{\mathbf{R3}_{\text{one}}} & \\
 \mathbf{Braids} & \xrightarrow{q_{\mathbf{R}\text{-moves}}} & & & \mathbf{Braids}/\mathbf{R}\text{-moves}
 \end{array}$$

(11) By the functoriality  $q_{\mathbf{R}\text{-moves}}$ , we deduce from (10) that the following diagram in  $\mathbf{Cat}$  commutes.

$$\begin{array}{ccc}
\mathcal{I} & \xrightarrow{\sigma_1^{-1} \circ \sigma_2^{-1} \circ \sigma_1 \circ \sigma_2 \circ \sigma_2^{-1}} & \text{Braids} \\
\sigma_1^{-1} \circ \sigma_2^{-1} \circ \sigma_1 \downarrow & & \downarrow q_{\text{R-moves}} \\
\text{Braids} & \xrightarrow{q_{\text{R-moves}}} & \text{Braids/R-moves}
\end{array}$$

(12) We deduce from (8) and (11) that the following diagram in  $\text{Cat}$  commutes, as required.

$$\begin{array}{ccc}
\mathcal{I} & \xrightarrow{\sigma_2 \circ \sigma_1^{-1} \circ \sigma_2^{-1}} & \text{Braids} \\
\sigma_1^{-1} \circ \sigma_2^{-1} \circ \sigma_1 \downarrow & & \downarrow q_{\text{R-moves}} \\
\text{Braids} & \xrightarrow{q_{\text{R-moves}}} & \text{Braids/R-moves}
\end{array}$$

□

**Corollary 3.1.2.39.** *The following diagram in  $\text{Cat}$  commutes.*

$$\begin{array}{ccc}
F(\mathcal{I}) & \xrightarrow{\text{R3}_{\text{five}}(\text{one half})} & \text{Braids} \\
\text{R3}_{\text{five}}(\text{other half}) \downarrow & & \downarrow q_{\text{R-moves}} \\
\text{Braids} & \xrightarrow{q_{\text{R-moves}}} & \text{Braids/R-moves}
\end{array}$$

*Proof.* We make the following observations.

(1) By definition of  $\text{R3}_{\text{five}}(\text{one half})$ , the following diagram in  $\text{Cat}$  commutes.

$$\begin{array}{ccc}
\mathcal{I} & \xrightarrow{i_{\mathcal{I}}} & F(\mathcal{I}) \\
\sigma_1^{-1} \circ \sigma_2^{-1} \circ \sigma_1 \searrow & & \downarrow \text{R3}_{\text{five}}(\text{one half}) \\
& & \text{Braids/R-moves}
\end{array}$$

(2) We deduce from (1) and Proposition 3.1.2.38 that the following diagram in  $\text{Cat}$  commutes.



$$\begin{array}{ccc}
\mathcal{I} & \xrightarrow{i_{\mathcal{I}}} & F(\mathcal{I}) \\
& \searrow & \downarrow \text{R3}_{\text{five}}(\text{one half}) \\
& & \text{Braids/R-moves}
\end{array}$$

$\sigma_2 \circ \sigma_1^{-1} \circ \sigma_2^{-1}$

(3) We deduce from (2) that the following diagram in  $\text{Cat}$  commutes.

$$\begin{array}{ccc}
\mathcal{I} & \xrightarrow{i_{\mathcal{I}}} & F(\mathcal{I}) \\
& \searrow & \downarrow q_{\text{R-moves}} \circ \text{R3}_{\text{five}}(\text{one half}) \\
& & \text{Braids/R-moves}
\end{array}$$

$q_{\text{R-moves}} \circ (\sigma_2 \circ \sigma_1^{-1} \circ \sigma_2^{-1})$

(4) By definition of  $\text{R3}_{\text{five}}(\text{other half})$ , the following diagram in  $\text{Cat}$  commutes.

$$\begin{array}{ccc}
\mathcal{I} & \xrightarrow{i_{\mathcal{I}}} & F(\mathcal{I}) \\
& \searrow & \downarrow \text{R3}_{\text{five}}(\text{other half}) \\
& & \text{Braids/R-moves}
\end{array}$$

$\sigma_2 \circ \sigma_1^{-1} \circ \sigma_2^{-1}$

(5) We deduce from (4) that the following diagram in  $\text{Cat}$  commutes.

$$\begin{array}{ccc}
\mathcal{I} & \xrightarrow{i_{\mathcal{I}}} & F(\mathcal{I}) \\
& \searrow & \downarrow q_{\text{R-moves}} \circ \text{R3}_{\text{five}}(\text{other half}) \\
& & \text{Braids/R-moves}
\end{array}$$

$q_{\text{R-moves}} \circ (\sigma_2 \circ \sigma_1^{-1} \circ \sigma_2^{-1})$

(6) Appealing to the universal property of  $F(\mathcal{I})$ , we deduce from (3) and (5) that the following diagram in  $\text{Cat}$  commutes, as required.

$$\begin{array}{ccc}
F(\mathcal{I}) & \xrightarrow{\text{R3}_{\text{five}}(\text{one half})} & \text{Braids} \\
\text{R3}_{\text{five}}(\text{other half}) \downarrow & & \downarrow q_{\text{R-moves}} \\
\text{Braids} & \xrightarrow{q_{\text{R-moves}}} & \text{Braids/R-moves}
\end{array}$$

□

**Notation 3.1.2.40.** Let

$$F(\mathcal{I}) \xrightarrow{\text{R3}_{\text{six}}(\text{one half})} \text{Braids}$$

be the strict monoidal functor to which, by means of the universal property of  $F(\mathcal{I})$ , the functor

$$\mathcal{I} \xrightarrow{\sigma_1^{-1} \circ \sigma_2^{-1} \circ \sigma_1^{-1}} \text{Braids}$$

gives rise.

**Notation 3.1.2.41.** Let

$$F(\mathcal{I}) \xrightarrow{\text{R3}_{\text{six}}(\text{other half})} \text{Braids}$$

be the strict monoidal functor to which, by means of the universal property of  $F(\mathcal{I})$ , the functor

$$\mathcal{I} \xrightarrow{\sigma_2^{-1} \circ \sigma_1^{-1} \circ \sigma_2^{-1}} \text{Braids}$$

gives rise.

**Remark 3.1.2.42.** The arrows  $\text{R3}_{\text{six}}(\text{one half})$  and  $\text{R3}_{\text{six}}(\text{other half})$  of  $\text{Braids}$  express algebraically the two halves of the R3 move which allows us to replace

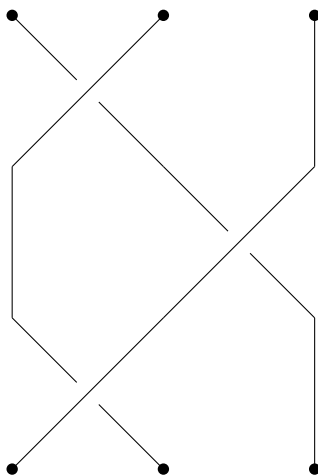

by the following, and vice versa.

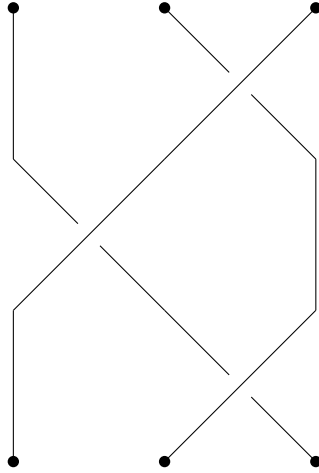

We refer to this R3 move as  $R3_{\text{six}}$ .

**Proposition 3.1.2.43.** *The following diagram in  $\text{Cat}$  commutes.*

$$\begin{array}{ccc}
 \mathcal{I} & \xrightarrow{\sigma_1^{-1} \circ \sigma_2^{-1} \circ \sigma_1^{-1}} & \text{Braids} \\
 \sigma_2^{-1} \circ \sigma_1^{-1} \circ \sigma_2^{-1} \downarrow & & \downarrow q_{\text{R-moves}} \\
 \text{Braids} & \xrightarrow{q_{\text{R-moves}}} & \text{Braids/R-moves}
 \end{array}$$

*Proof.* We make the following observations.

(1) By Proposition 3.1.2.33 the following diagram in  $\text{Cat}$  commutes.

$$\begin{array}{ccc}
 \mathcal{I} & \xrightarrow{\sigma_1 \circ \sigma_2^{-1} \circ \sigma_1^{-1}} & \text{Braids} \\
 \sigma_2^{-1} \circ \sigma_1^{-1} \circ \sigma_2 \downarrow & & \downarrow q_{\text{R-moves}} \\
 \text{Braids} & \xrightarrow{q_{\text{R-moves}}} & \text{Braids/R-moves}
 \end{array}$$

(2) By the functoriality of  $q_{\text{R-moves}}$ , we deduce from (1) that the following diagram in  $\text{Cat}$  commutes.

$$\begin{array}{ccc}
 \mathcal{I} & \xrightarrow{\sigma_1^{-1} \circ \sigma_1 \circ \sigma_2^{-1} \circ \sigma_1^{-1}} & \text{Braids} \\
 \sigma_1^{-1} \circ \sigma_2^{-1} \circ \sigma_1^{-1} \circ \sigma_2 \downarrow & & \downarrow q_{\text{R-moves}} \\
 \text{Braids} & \xrightarrow{q_{\text{R-moves}}} & \text{Braids/R-moves}
 \end{array}$$

(3) By definition of  $\text{Braids}/R2_{\text{one}}$ , the following diagram in  $\text{Cat}$  commutes.

$$\begin{array}{ccc}
 \mathcal{I} & \xrightarrow{id(3)} & \text{Braids} \\
 \sigma_1^{-1} \circ \sigma_1 \downarrow & & \downarrow q_{R2_{\text{both}}} \\
 \text{Braids} & \xrightarrow{q_{R2_{\text{both}}}} & \text{Braids}/R2_{\text{both}}
 \end{array}$$

(4) We deduce from (3) that the following diagram in  $\text{Cat}$  commutes.

$$\begin{array}{ccccc}
 \mathcal{I} & \xrightarrow{id(3)} & & & \text{Braids} \\
 \sigma_1^{-1} \circ \sigma_1 \downarrow & & & & \downarrow q_{R2_{\text{both}}} \\
 & & \text{Braids}/R2_{\text{one}} & & \\
 & q_{R2_{\text{one}}} \nearrow & & \nwarrow q_{R2_{\text{two}}} & \\
 \text{Braids} & \xrightarrow{q_{R2_{\text{both}}}} & & & \text{Braids}/R2_{\text{both}}
 \end{array}$$

(5) We deduce from (4) that the following diagram in  $\text{Cat}$  commutes.

$$\begin{array}{ccccc}
 \mathcal{I} & \xrightarrow{id(3)} & & & \text{Braids} \\
 \sigma_1^{-1} \circ \sigma_1 \downarrow & & & & \downarrow q_{R\text{-moves}} \\
 & & \text{Braids}/R2_{\text{both}} & & \\
 & q_{R2_{\text{both}}} \nearrow & & \nwarrow q_{R3_{\text{one}}} & \\
 \text{Braids} & \xrightarrow{q_{R\text{-moves}}} & & & \text{Braids}/R\text{-moves}
 \end{array}$$

(6) By the functoriality  $q_{R\text{-moves}}$ , we deduce from (5) that the following diagram in  $\text{Cat}$  commutes.

$$\begin{array}{ccc}
 \mathcal{I} & \xrightarrow{\sigma_2^{-1} \circ \sigma_1^{-1}} & \text{Braids} \\
 \sigma_1^{-1} \circ \sigma_1 \circ \sigma_2^{-1} \circ \sigma_1^{-1} \downarrow & & \downarrow q_{R\text{-moves}} \\
 \text{Braids} & \xrightarrow{q_{R\text{-moves}}} & \text{Braids}/R\text{-moves}
 \end{array}$$

(7) We deduce from (2) and (6) that the following diagram in  $\mathbf{Cat}$  commutes.

$$\begin{array}{ccc}
 \mathcal{I} & \xrightarrow{\sigma_2^{-1} \circ \sigma_1^{-1}} & \mathbf{Braids} \\
 \sigma_1^{-1} \circ \sigma_2^{-1} \circ \sigma_1^{-1} \circ \sigma_2 \downarrow & & \downarrow q_{\mathbf{R}\text{-moves}} \\
 \mathbf{Braids} & \xrightarrow{q_{\mathbf{R}\text{-moves}}} & \mathbf{Braids}/\mathbf{R}\text{-moves}
 \end{array}$$

(8) By the functoriality  $q_{\mathbf{R}\text{-moves}}$ , we deduce from (7) that the following diagram in  $\mathbf{Cat}$  commutes.

$$\begin{array}{ccc}
 \mathcal{I} & \xrightarrow{\sigma_2^{-1} \circ \sigma_1^{-1} \circ \sigma_2^{-1}} & \mathbf{Braids} \\
 \sigma_1^{-1} \circ \sigma_2^{-1} \circ \sigma_1^{-1} \circ \sigma_2 \circ \sigma_2^{-1} \downarrow & & \downarrow q_{\mathbf{R}\text{-moves}} \\
 \mathbf{Braids} & \xrightarrow{q_{\mathbf{R}\text{-moves}}} & \mathbf{Braids}/\mathbf{R}\text{-moves}
 \end{array}$$

(9) By definition of  $\mathbf{Braids}/\mathbf{R2}_{\text{both}}$ , the following diagram in  $\mathbf{Cat}$  commutes.

$$\begin{array}{ccc}
 \mathcal{I} & \xrightarrow{\sigma_2 \circ \sigma_2^{-1}} & \mathbf{Braids} \\
 id(3) \downarrow & & \downarrow q_{\mathbf{R2}_{\text{both}}} \\
 \mathbf{Braids} & \xrightarrow{q_{\mathbf{R2}_{\text{both}}}} & \mathbf{Braids}/\mathbf{R2}_{\text{both}}
 \end{array}$$

(10) We deduce from (9) that the following diagram in  $\mathbf{Cat}$  commutes.

$$\begin{array}{ccccc}
 \mathcal{I} & \xrightarrow{\sigma_2 \circ \sigma_2^{-1}} & & & \mathbf{Braids} \\
 \downarrow id(3) & & & & \downarrow q_{\mathbf{R}\text{-moves}} \\
 & & \mathbf{Braids}/\mathbf{R2}_{\text{both}} & & \\
 & \nearrow q_{\mathbf{R2}_{\text{both}}} & & \searrow q_{\mathbf{R3}_{\text{one}}} & \\
 \mathbf{Braids} & \xrightarrow{q_{\mathbf{R}\text{-moves}}} & & & \mathbf{Braids}/\mathbf{R}\text{-moves}
 \end{array}$$

(11) By the functoriality  $q_{\mathbf{R}\text{-moves}}$ , we deduce from (10) that the following diagram in  $\mathbf{Cat}$  commutes.

$$\begin{array}{ccc}
\mathcal{I} & \xrightarrow{\sigma_1^{-1} \circ \sigma_2^{-1} \circ \sigma_1^{-1} \circ \sigma_2 \circ \sigma_2^{-1}} & \text{Braids} \\
\sigma_1^{-1} \circ \sigma_2^{-1} \circ \sigma_1^{-1} \downarrow & & \downarrow q_{\text{R-moves}} \\
\text{Braids} & \xrightarrow{q_{\text{R-moves}}} & \text{Braids/R-moves}
\end{array}$$

(12) We deduce from (8) and (11) that the following diagram in  $\text{Cat}$  commutes, as required.

$$\begin{array}{ccc}
\mathcal{I} & \xrightarrow{\sigma_2^{-1} \circ \sigma_1^{-1} \circ \sigma_2^{-1}} & \text{Braids} \\
\sigma_1^{-1} \circ \sigma_2^{-1} \circ \sigma_1^{-1} \downarrow & & \downarrow q_{\text{R-moves}} \\
\text{Braids} & \xrightarrow{q_{\text{R-moves}}} & \text{Braids/R-moves}
\end{array}$$

□

**Corollary 3.1.2.44.** *The following diagram in  $\text{Cat}$  commutes.*

$$\begin{array}{ccc}
F(\mathcal{I}) & \xrightarrow{\text{R3}_{\text{six}}(\text{one half})} & \text{Braids} \\
\text{R3}_{\text{six}}(\text{other half}) \downarrow & & \downarrow q_{\text{R-moves}} \\
\text{Braids} & \xrightarrow{q_{\text{R-moves}}} & \text{Braids/R-moves}
\end{array}$$

*Proof.* We make the following observations.

(1) By definition of  $\text{R3}_{\text{six}}(\text{one half})$ , the following diagram in  $\text{Cat}$  commutes.

$$\begin{array}{ccc}
\mathcal{I} & \xrightarrow{i_{\mathcal{I}}} & F(\mathcal{I}) \\
\sigma_1^{-1} \circ \sigma_2^{-1} \circ \sigma_1^{-1} \searrow & & \downarrow \text{R3}_{\text{six}}(\text{one half}) \\
& & \text{Braids/R-moves}
\end{array}$$

(2) We deduce from (1) and Proposition 3.1.2.43 that the following diagram in  $\text{Cat}$  commutes.

$$\begin{array}{ccc}
\mathcal{I} & \xrightarrow{i_{\mathcal{I}}} & F(\mathcal{I}) \\
& \searrow & \downarrow \text{R3}_{\text{six}}(\text{one half}) \\
& & \text{Braids/R-moves}
\end{array}$$

$\sigma_2^{-1} \circ \sigma_1^{-1} \circ \sigma_2^{-1}$

(3) We deduce from (2) that the following diagram in  $\text{Cat}$  commutes.

$$\begin{array}{ccc}
\mathcal{I} & \xrightarrow{i_{\mathcal{I}}} & F(\mathcal{I}) \\
& \searrow & \downarrow q_{\text{R-moves}} \circ \text{R3}_{\text{six}}(\text{one half}) \\
& & \text{Braids/R-moves}
\end{array}$$

$q_{\text{R-moves}} \circ (\sigma_2^{-1} \circ \sigma_1^{-1} \circ \sigma_2^{-1})$

(4) By definition of  $\text{R3}_{\text{six}}(\text{other half})$ , the following diagram in  $\text{Cat}$  commutes.

$$\begin{array}{ccc}
\mathcal{I} & \xrightarrow{i_{\mathcal{I}}} & F(\mathcal{I}) \\
& \searrow & \downarrow \text{R3}_{\text{six}}(\text{other half}) \\
& & \text{Braids/R-moves}
\end{array}$$

$\sigma_2^{-1} \circ \sigma_1^{-1} \circ \sigma_2^{-1}$

(5) We deduce from (4) that the following diagram in  $\text{Cat}$  commutes.

$$\begin{array}{ccc}
\mathcal{I} & \xrightarrow{i_{\mathcal{I}}} & F(\mathcal{I}) \\
& \searrow & \downarrow q_{\text{R-moves}} \circ \text{R3}_{\text{six}}(\text{other half}) \\
& & \text{Braids/R-moves}
\end{array}$$

$q_{\text{R-moves}} \circ (\sigma_2^{-1} \circ \sigma_1^{-1} \circ \sigma_2^{-1})$

(6) Appealing to the universal property of  $F(\mathcal{I})$ , we deduce from (3) and (5) that the following diagram in  $\text{Cat}$  commutes, as required.

$$\begin{array}{ccc}
F(\mathcal{I}) & \xrightarrow{\text{R3}_{\text{six}}(\text{one half})} & \text{Braids} \\
\text{R3}_{\text{six}}(\text{other half}) \downarrow & & \downarrow q_{\text{R-moves}} \\
\text{Braids} & \xrightarrow{q_{\text{R-moves}}} & \text{Braids/R-moves}
\end{array}$$

□

**Remark 3.1.2.45.** The objects of **Braids/R-moves** are the same as those of **Braids**. Let us regard two braids as equivalent if one can be obtained from the other by a finite sequence of the Reidemeister moves  $R2_{\text{one}}$ ,  $R2_{\text{two}}$ ,  $R3_{\text{one}}$ ,  $R3_{\text{two}}$ ,  $\dots$ ,  $R3_{\text{six}}$ , namely if they are *isotopic*. Proposition 3.1.2.22, Proposition 3.1.2.28, Proposition 3.1.2.33, Proposition 3.1.2.38, and Proposition 3.1.2.43 establish that the arrows of **Braids/R-moves** can be thought of as braids up to this notion of equivalence, or, in other words, braids up to isotopy, even though the definition of **Braids/R-moves** only involved  $R2_{\text{one}}$ ,  $R2_{\text{two}}$ , and  $R3_{\text{one}}$ .

**Remark 3.1.2.46.** Let  $\mathcal{B}_n$  denote the braid group on  $n$  strands, in the usual sense, viewed as a category with one object. Then **Braids/R-moves** is in fact isomorphic to  $\bigsqcup_{n \geq 0} \mathcal{B}_n$ , where this coproduct is taken in **Cat**. Indeed, the full subcategory of **Braids/R-moves** on the single object  $n$  is in fact isomorphic to  $\mathcal{B}_n$ .

As first observed in the paper [8] of Joyal and Street, and its later version [9], the category  $\bigsqcup_{n \geq 0} \mathcal{B}_n$  is the free braided monoidal category on  $1_{\text{cat}}$ .

We shall not make use of this description or universal property of **Braids/R-moves** in this work, and omit a formal statement and proof.



## 3.2. Temperley-Lieb categories and Markov trace functors

We define a category  $\mathcal{TL}$ , whose arrows we think of as diagrammatic tangles, as a free 2-ring on a monoidal datum  $\mathbb{M}_{\mathcal{TL}}$ . Next, we introduce the notion of a datum for smoothing of braids. Given such a datum  $\mathbb{S}$ , we define from  $\mathcal{TL}$  a 2-ring  $\mathcal{TL}(\mathbb{S})$  in two steps, via a 2-ring  $\mathcal{TL}(\mathbb{S})^{\text{pre}}$ . We think of the arrows of  $\mathcal{TL}(\mathbb{S})$  as linearisations of diagrammatic tangles.

Following this, we introduce the notion of a Markov trace datum with respect to a 2-ring. Given such a datum  $\mathbb{T}$ , we construct a functor of 2-rings from  $\mathcal{TL}(\mathbb{S})$  to a 2-ring  $\mathbb{T}$  defined by means of  $\mathbb{T}$ . On arrows, we think of this functor as taking the Markov trace of a linearised diagrammatic tangle.

We conclude with two auxiliary constructions. First, given a 2-ring  $\mathbb{R}$ , we construct a datum for smoothing of braids. Second, given again a 2-ring  $\mathbb{R}$ , we construct a Markov trace datum with respect to it.

### 3.2.1. The Temperley-Lieb category

**Notation 3.2.1.1.** Let

$$\begin{array}{ccc} \partial\mathcal{I} & \xrightarrow{(2,2)} & 1_{\text{Cat}} \sqcup 1_{\text{Cat}} \\ (0,1) \downarrow & & \downarrow r_0^{\mathcal{TL}_{\leq 2}} \\ \mathcal{I} & \xrightarrow{r_1^{\mathcal{TL}_{\leq 2}}} & \mathcal{TL}_{\leq 2} \end{array}$$

be a co-cartesian square in  $\text{Cat}$ .

**Notation 3.2.1.2.** We denote the object of  $\mathcal{TL}_{\leq 2}$  corresponding to the functor

$$1_{\text{Cat}} \xrightarrow{r_0^{\mathcal{TL}_{\leq 2}} \circ 1} \mathcal{TL}_{\leq 2}$$

by 1, and depict it as follows.

•

We denote the object of  $\mathcal{TL}_{\leq 2}$  corresponding to the functor

$$1_{\text{Cat}} \xrightarrow{r_0^{\mathcal{TL}_{\leq 2}} \circ 2} \mathcal{TL}_{\leq 2}$$

by 2, and depict it as follows.



We depict the arrow

$$1 \xrightarrow{id(1)} 1$$

of  $\mathcal{TL}_{\leq 2}$  as follows.



We depict the arrow

$$2 \xrightarrow{id(2)} 2$$

of  $\mathcal{TL}_{\leq 2}$  as follows.

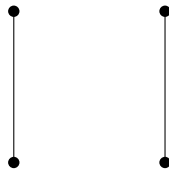

We denote the arrow of  $\mathcal{TL}_{\leq 2}$  corresponding to the functor

$$\mathcal{I} \xrightarrow{r_1^{\mathcal{TL}_{\leq 2}}} \mathcal{TL}_{\leq 2}$$

by *CupAndCap*, and depict it as follows.

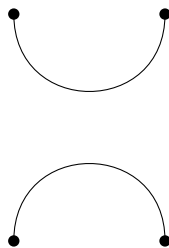

**Remark 3.2.1.3.** The definition of  $\mathcal{TL}_{\leq 2}$  can be thought of as follows. We begin with a category consisting of exactly two objects, 1 and 2, and no non-identity arrows. We then proceed as follows.

(1) We add an arrow

$$2 \longrightarrow 2,$$

which we denote by **CupAndCap**.

(2) We then add exactly those further arrows

$$2 \longrightarrow 2$$

that we need to have a category, namely arbitrary finite compositions of **CupAndCap**.

As this description makes clear,  $\mathbf{TL}_{\leq 2}$  can also be defined as the free category on the directed graph consisting of exactly two objects 1, 2, and exactly one arrow

$$2 \longrightarrow 2.$$

However, we prefer the more direct approach, working purely within **Cat**, that we have taken.

**Notation 3.2.1.4.** Let

$$\mathbf{TL}_{\leq 2} \xleftarrow{p_1^{\mathbf{TL}_{\leq 2}}} \mathbf{TL}_{\leq 2} \times \mathbf{TL}_{\leq 2} \xrightarrow{p_2^{\mathbf{TL}_{\leq 2}}} \mathbf{TL}_{\leq 2}$$

be a diagram in **Cat** which defines a binary product.

**Notation 3.2.1.5.** Let

$$1_{\mathbf{Cat}} \xrightarrow{(1,1)} \mathbf{TL}_{\leq 2} \times \mathbf{TL}_{\leq 2}$$

be the canonical functor such that the following diagram in **Cat** commutes.

$$\begin{array}{ccccc}
 & & 1_{\mathbf{Cat}} & & \\
 & \swarrow & \downarrow & \searrow & \\
 & 1 & (1,1) & 1 & \\
 \mathbf{TL}_{\leq 2} & \xleftarrow{p_1^{\mathbf{TL}_{\leq 2}}} & \mathbf{TL}_{\leq 2} \times \mathbf{TL}_{\leq 2} & \xrightarrow{p_2^{\mathbf{TL}_{\leq 2}}} & \mathbf{TL}_{\leq 2}
 \end{array}$$

**Definition 3.2.1.6.** The *Temperley-Lieb 2-ring* is, appealing to Fact 2.2.2.2, the free 2-ring on the monoidal datum  $\mathbb{M}_{\mathbf{TL}} = (1_{\mathbf{Cat}}, \mathbf{TL}_{\leq 2}, (1, 1), 2)$  internal to **Cat**.

**Terminology 3.2.1.7.** We refer to the category which is part of the data of TL as the *Temperley-Lieb category*.

**Notation 3.2.1.8.** We denote both the Temperley-Lieb 2-ring and Temperley-Lieb category by TL. We denote by  $\text{can}_{\text{TL}}$  the canonical functor

$$\text{TL}_{\leq 2} \longrightarrow \text{TL}.$$

**Remark 3.2.1.9.** The construction of the category TL can be thought of in two steps. First, we take the free strict monoidal category on  $\text{TL}_{\leq 2}$ , subject to the requirement that  $1 \otimes 1 = 2$ . Let us denote this category by  $\text{F}(\text{TL}_{\leq 2})$ . The objects of  $\text{F}(\text{TL}_{\leq 2})$  can, as with the objects of **Braids**, be thought of as the symbols

$$\underbrace{1 \otimes \cdots \otimes 1}_n$$

for  $n \geq 0$ . We again depict

$$\underbrace{1 \otimes \cdots \otimes 1}_n$$

as follows, for  $n \geq 1$ .

$$\bullet \quad \cdots \quad \bullet$$

We sometimes denote the symbol

$$\underbrace{1 \otimes \cdots \otimes 1}_n$$

simply by  $n$ .

The arrows of  $\text{F}(\text{TL}_{\leq 2})$  can be thought of as built from those of  $\text{TL}_{\leq 2}$  by horizontal concatenation. Thus, for instance, there is an arrow

$$1 \otimes 1 \otimes 1 \xrightarrow{\text{id}(1) \otimes \text{CupAndCap}} 1 \otimes 1 \otimes 1,$$

which we depict as follows.

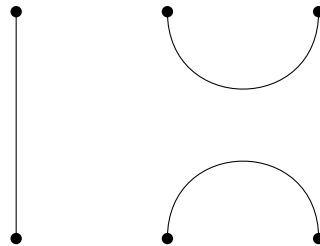

We think of the unit object of  $F(\mathbf{TL}_{\leq 2})$ , which we denote by  $0$ , as the ‘empty tangle’, or the ‘tangle with zero arcs’.

From this description, we see that the arrows of  $F(\mathbf{TL}_{\leq 2})$ , correspond exactly to the diagrammatic tangles, in the topological sense, used to define the Temperley-Lieb algebras  $\mathcal{T}_n$  for  $n \geq 0$  in §III of [13].

We then define  $\mathbf{TL}$  to be the free 2-ring on  $F(\mathbf{TL}_{\leq 2})$ , subject to the requirement that the multiplicative monoidal structure  $\mathbf{TL}$  coincides with the monoidal structure on  $F(\mathbf{TL}_{\leq 2})$  when we view the latter category as living inside  $\mathbf{TL}$ . The crucial aspect, for us, of  $\mathbf{TL}$  as compared to  $F(\mathbf{TL}_{\leq 2})$  is that we have a notion of addition of arrows of  $F(\mathbf{TL}_{\leq 2})$ , thought of as diagrammatic tangles, by means of the symmetric monoidal structure  $(\oplus, 0)$  of  $\mathbf{TL}$ . For instance, there is an arrow of  $\mathbf{TL}$  given by

$$\text{CupAndCap} \oplus \text{CupAndCap} \oplus (\text{id}(1) \otimes \text{CupAndCap}),$$

or

$$2 \cdot \text{CupAndCap} \oplus (\text{id}(1) \otimes \text{CupAndCap})$$

for short.

However, we shall not make use of a two-step construction of this kind, or any other construction or explicit description of  $\mathbf{TL}$  in our formal work. We shall appeal only to its universal property.

**Notation 3.2.1.10.** We depict composition in both  $\mathbf{TL}_{\leq 2}$  and  $\mathbf{TL}$  as vertical concatenation. For instance, we depict the arrow

$$2 \xrightarrow{\text{CupAndCap} \circ \text{CupAndCap}} 2$$

in either  $\mathbf{TL}_{\leq 2}$  or  $\mathbf{TL}$  as follows.

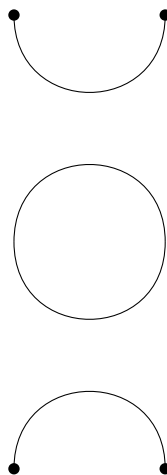

### 3.2.2. The Temperley-Lieb category with respect to a datum for smoothing of braids

**Definition 3.2.2.1.** A datum for smoothing of braids consists of the following data.

- (1) A 2-ring  $R$ . We shall also denote by  $R$  the category which is part of its data.
- (2) An arrow  $A$  of  $R$ .
- (3) An arrow  $B$  of  $R$ .

**Assumption 3.2.2.2.** Let  $\mathbb{S} = (R, A, B)$  be a datum for smoothing of braids.

**Notation 3.2.2.3.** Appealing to Fact 2.1.3.16, let

$$R \xrightarrow{i_1^{\cdot, \text{TL}(\mathbb{S})^{\text{pre}}, bi}} \text{TL}(\mathbb{S})^{\text{pre}} \xleftarrow{i_2^{\cdot, \text{TL}(\mathbb{S})^{\text{pre}}, bi}} \text{TL}$$

be a diagram in  $\text{Ring}(\text{Cat})$  which defines a binary coproduct.

**Terminology 3.2.2.4.** We refer to  $\text{TL}(\mathbb{S})^{\text{pre}}$  as the *pre-Temperley-Lieb category with respect to  $\mathbb{S}$* .

**Notation 3.2.2.5.** We denote the functor of 2-rings

$$\text{TL} \xrightarrow{i_2^{\cdot, \text{TL}(\mathbb{S})^{\text{pre}}, bi}} \text{TL}(\mathbb{S})^{\text{pre}}$$

by  $\text{can}_{\text{TL}(\mathbb{S})^{\text{pre}}}$ .

**Notation 3.2.2.6.** Let us denote the category which is part of the data of  $\text{TL}(\mathbb{S})^{\text{pre}}$  by  $\text{TL}(\mathbb{S})^{\text{pre}}$ .

**Notation 3.2.2.7.** Let

$$\text{TL}(\mathbb{S})^{\text{pre}} \xleftarrow{p_1^{\cdot, \text{TL}(\mathbb{S})^{\text{pre}}, bi}} \text{TL}(\mathbb{S})^{\text{pre}} \times \text{TL}(\mathbb{S})^{\text{pre}} \xrightarrow{p_2^{\cdot, \text{TL}(\mathbb{S})^{\text{pre}}, bi}} \text{TL}(\mathbb{S})^{\text{pre}}$$

be the diagram in  $\text{Cat}$  which is part of the data of  $\text{TL}(\mathbb{S})^{\text{pre}}$ , which defines a binary product.

**Notation 3.2.2.8.** Appealing to Fact 2.2.2.2, let us denote the free 2-ring on  $\mathcal{I}$  by  $F_{2\text{-Ring}}(\mathcal{I})$ .

**Notation 3.2.2.9.** Let  $f$  be an arrow of  $\text{TL}$ . We then also denote by  $f$  the canonical functor of 2-rings

$$F_{2\text{-Ring}}(\mathcal{I}) \longrightarrow \text{TL}(\mathbb{S})^{\text{pre}}$$

to which the functor

$$\mathcal{I} \xrightarrow{f} \mathrm{TL}(\mathbb{S})^{\mathrm{pre}}$$

gives rise by means of the universal property of  $\mathrm{F}_{2\text{-Ring}}(\mathcal{I})$ .

**Notation 3.2.2.10.** Let  $f$  and  $g$  be arrows of  $\mathrm{TL}$ . Let us denote by  $(f, g)$  the canonical functor of 2-rings

$$\mathrm{F}_{2\text{-Ring}}(\mathcal{I}) \longrightarrow \mathrm{TL}(\mathbb{S})^{\mathrm{pre}} \times \mathrm{TL}(\mathbb{S})^{\mathrm{pre}}$$

such that the following diagram in  $\mathrm{Ring}(\mathrm{Cat})$  commutes.

$$\begin{array}{ccccc} & & \mathrm{F}_{2\text{-Ring}}(\mathcal{I}) & & \\ & \swarrow & \downarrow (f, g) & \searrow & \\ & i_1^{\mathrm{TL}(\mathbb{S}), bi} \circ f & & & i_2^{\mathrm{TL}(\mathbb{S}), bi} \circ g \\ & & \mathrm{TL}(\mathbb{S})^{\mathrm{pre}} \times \mathrm{TL}(\mathbb{S})^{\mathrm{pre}} & & \\ & \swarrow & & \searrow & \\ \mathrm{TL}(\mathbb{S})^{\mathrm{pre}} & \xleftarrow{p_1^{\mathrm{TL}(\mathbb{S})^{\mathrm{pre}}, bi}} & & \xrightarrow{p_2^{\mathrm{TL}(\mathbb{S})^{\mathrm{pre}}, bi}} & \mathrm{TL}(\mathbb{S})^{\mathrm{pre}} \end{array}$$

We denote by  $f \otimes g$  the arrow of  $\mathrm{TL}(\mathbb{S})^{\mathrm{pre}}$  corresponding to the functor

$$\mathcal{I} \xrightarrow{\otimes_{\mathrm{TL}(\mathbb{S})} \circ (f, g)} \mathrm{TL}(\mathbb{S})^{\mathrm{pre}}.$$

**Remark 3.2.2.11.** In this way, we in particular have a notion of multiplication of arrows of  $\mathrm{TL}(\mathbb{S})^{\mathrm{pre}}$ , thought of as formal sums of diagrammatic tangles, by  $A$  and  $B$ . This, for us, is the crucial difference between  $\mathrm{TL}(\mathbb{S})^{\mathrm{pre}}$  and  $\mathrm{TL}$ .

**Notation 3.2.2.12.** Appealing to Fact 2.2.2.2, let us denote the free 2-ring on  $1_{\mathrm{Cat}}$  by  $\mathrm{F}_{2\text{-ring}}(1_{\mathrm{Cat}})$ .

**Notation 3.2.2.13.** Let us denote by

$$\mathrm{F}_{2\text{-ring}}(1_{\mathrm{Cat}}) \xrightarrow{2} \mathrm{TL}(\mathbb{S})^{\mathrm{pre}}$$

the canonical functor of 2-rings to which the functor

$$1_{\mathrm{Cat}} \xrightarrow{i_2^{\mathrm{TL}(\mathbb{S})^{\mathrm{pre}}, bi} \circ 2} \mathrm{TL}(\mathbb{S})^{\mathrm{pre}}$$

gives rise by means of the universal property of  $\mathrm{F}_{2\text{-ring}}(1_{\mathrm{Cat}})$ .

**Notation 3.2.2.14.** Let us denote the source and target of the arrow  $A$  of  $\mathbb{R}$  by  $a_0$  and  $a_1$  respectively, and the source and target of the arrow  $B$  of  $\mathbb{R}$  by  $b_0$  and  $b_1$  respectively.

**Notation 3.2.2.15.** Let us denote by

$$\partial\mathcal{I} \xrightarrow{((a_0 \otimes 2) \oplus (b_0 \otimes 2), (a_1 \otimes 2) \oplus (b_1 \otimes 2))} \mathrm{TL}(\mathbb{S})^{\mathrm{pre}}$$

the functor determined by the objects  $(a_0 \otimes 2) \oplus (b_0 \otimes 2)$  and  $(a_1 \otimes 2) \oplus (b_1 \otimes 2)$  of  $\mathrm{TL}(\mathbb{S})^{\mathrm{pre}}$ .

**Notation 3.2.2.16.** Appealing to Fact 2.2.2.2, let us denote the free 2-ring on  $\partial\mathcal{I}$  by  $F_{2\text{-ring}}(\partial\mathcal{I})$ .

**Notation 3.2.2.17.** Let us denote by

$$F_{2\text{-ring}}(\partial\mathcal{I}) \xrightarrow{((a_0 \otimes 2) \oplus (b_0 \otimes 2), (a_1 \otimes 2) \oplus (b_1 \otimes 2))} \mathrm{TL}(\mathbb{S})^{\mathrm{pre}}$$

the functor of 2-rings to which the functor

$$\partial\mathcal{I} \xrightarrow{((a_0 \otimes 2) \oplus (b_0 \otimes 2), (a_1 \otimes 2) \oplus (b_1 \otimes 2))} \mathrm{TL}(\mathbb{S})^{\mathrm{pre}}$$

gives rise by means of the universal property of  $F_{2\text{-ring}}(\partial\mathcal{I})$ .

**Notation 3.2.2.18.** Appealing to Fact 2.1.3.16, let

$$F_{2\text{-ring}}(\partial\mathcal{I}) \begin{array}{c} \xrightarrow{\quad\quad\quad} \\ \xrightarrow{\quad\quad\quad} \\ \quad\quad\quad (2, 2) \end{array} \mathrm{TL}(\mathbb{S})^{\mathrm{pre}} \xrightarrow{\mathrm{can}_{\mathrm{TL}(\mathbb{S})}} \mathrm{TL}(\mathbb{S})$$

be a diagram, in which the unlabelled arrow is

$$F_{2\text{-ring}}(\partial\mathcal{I}) \xrightarrow{((a_0 \otimes 2) \oplus (b_0 \otimes 2), (a_1 \otimes 2) \oplus (b_1 \otimes 2))} \mathrm{TL}(\mathbb{S})^{\mathrm{pre}},$$

in  $\mathrm{Ring}(\mathrm{Cat})$  which defines a coequaliser.

**Remark 3.2.2.19.** The idea of the construction of  $\mathrm{TL}(\mathbb{S})$  from  $\mathrm{TL}(\mathbb{S})^{\mathrm{pre}}$  is that we identify both of the objects  $(a_0 \otimes 2) \oplus (b_0 \otimes 2)$  and  $(a_1 \otimes 2) \oplus (b_1 \otimes 2)$  of  $\mathrm{TL}(\mathbb{S})^{\mathrm{pre}}$  with the object 2 of  $\mathrm{TL}(\mathbb{S})^{\mathrm{pre}}$ . This ensures that certain arrows of  $\mathrm{TL}(\mathbb{S})$  which we shall make crucial use of in §3.3 are endomorphisms of 2, which we shall require in order to exhibit  $\mathbb{M}_{\mathrm{Braids}}$  as a monoidal datum for  $\mathrm{TL}(\mathbb{S})$ .

Because of the way in which we will make use of  $\mathrm{TL}(\mathbb{S})$  in §3.3, we shall typically think of the arrows of  $\mathrm{TL}(\mathbb{S})$  as formal linear combinations of diagrammatic tangles, the coefficients of which are non-commutative polynomials in  $A$  and  $B$ , built out of  $\oplus$  and  $\otimes$ . There are, though, many arrows of  $\mathrm{TL}(\mathbb{S})$  which are not of this form.



**Remark 3.2.2.20.** In Remark 3.1.2.46, we observed that it is possible to view **Braids** as the coproduct of the braid groups  $\mathcal{B}_n$  for  $n \geq 0$ . It is not possible to view  $\mathrm{TL}(\mathbb{S})$  as built out the Temperley-Lieb algebras  $\mathcal{T}_n$  in this way. If, as discussed in Remark 2.1.3.18, we had chosen to construct  $\mathrm{TL}(\mathbb{S})$  as an enriched monoidal category rather than as a 2-ring, the Temperley-Lieb category we obtained would have been the coproduct  $\bigsqcup_{n \geq 0} \mathcal{T}_n$ , viewing  $\mathcal{T}_n$  as an enriched monoidal category with one object.

Nevertheless, supposing temporarily, for simplicity, that we assume our 2-rings to be commutative, let  $\mathbb{R}$  be the 2-ring which we can think of as follows. The set of objects of  $\mathbb{R}$  is  $\mathbb{N}$ , the set of natural numbers. For every natural number  $n$ , viewed as an object of  $\mathbb{R}$ , the set of endomorphisms of  $n$  can also be thought of as  $\mathbb{N}$ . There are no arrows of  $\mathbb{R}$  which are not endomorphisms. The ring operations on objects are those of  $\mathbb{N}$ . The ring operations on arrows are also those of  $\mathbb{N}$ , understood in the only possible way: if  $e$  is an endomorphism of a natural number  $m$ , and  $f$  is an endomorphism of a natural number  $n$ , then  $e + f$  is an endomorphism of  $m + n$ , and similarly for multiplication.

Let  $\mathbb{R}[A, B]$  be the 2-ring obtained by freely adding a pair of arrows  $A$  and  $B$  to  $\mathbb{R}$ . This construction is carried out formally in §3.2.4. Let  $\mathbb{S}$  be the datum for smoothing of braids given by  $(\mathbb{R}, A, B)$ . Then the arrows of  $\mathrm{TL}(\mathbb{S})$  are exactly the same as those of  $\bigsqcup_{n \geq 0} \mathcal{T}\mathcal{L}_n$ , if  $\mathcal{T}\mathcal{L}_n$  is taken to be an algebra over  $\mathbb{N}[A, B]$ . It is only on objects that the two categories differ.

### 3.2.3. Markov trace functors

**Definition 3.2.3.1.** Let  $\mathbb{R}$  be a 2-ring. A *Markov trace datum* with respect to  $\mathbb{R}$  consists of the following data.

- (1) A 2-ring  $\mathbb{T}^{\mathrm{pre}}$ .
- (2) An arrow

$$1_{\mathbb{T}^{\mathrm{pre}}} \xrightarrow{\gamma} 1_{\mathbb{T}^{\mathrm{pre}}}$$

of  $\mathbb{T}^{\mathrm{pre}}$ .

- (3) A functor of 2-rings

$$\mathbb{R} \xrightarrow{t} \mathbb{T}^{\mathrm{pre}}.$$

**Assumption 3.2.3.2.** Let  $\mathbb{R}$  be a 2-ring, and let  $\mathbb{T} = (\mathbb{T}^{\mathrm{pre}}, \gamma, t)$  be a Markov trace datum with respect to  $\mathbb{R}$ . Let us denote by  $\mathbb{T}^{\mathrm{pre}}$  the category which is part of the data of  $\mathbb{T}^{\mathrm{pre}}$ .

**Notation 3.2.3.3.** Let

$$1_{\text{Cat}} \sqcup 1_{\text{Cat}} \xrightarrow{1_{\mathbb{T}^{\text{pre}}} \sqcup 1_{\mathbb{T}^{\text{pre}}}} \mathbb{T}^{\text{pre}}$$

denote the canonical functor such that the following diagram in  $\text{Cat}$ , in which it is the unlabelled middle arrow, commutes.

$$\begin{array}{ccccc} 1_{\text{Cat}} & \xrightarrow{1} & 1_{\text{Cat}} \sqcup 1_{\text{Cat}} & \xleftarrow{2} & 1_{\text{Cat}} \\ & \searrow 1_{\mathbb{T}^{\text{pre}}} & \downarrow & \swarrow 1_{\mathbb{T}^{\text{pre}}} & \\ & & \mathbb{T}^{\text{pre}} & & \end{array}$$

**Proposition 3.2.3.4.** *The following diagram in  $\text{Cat}$  commutes.*

$$\begin{array}{ccc} \partial \mathcal{I} & \xrightarrow{(2,2)} & 1_{\text{Cat}} \sqcup 1_{\text{Cat}} \\ (0,1) \downarrow & & \downarrow 1_{\mathbb{T}^{\text{pre}}} \sqcup 1_{\mathbb{T}^{\text{pre}}} \\ \mathcal{I} & \xrightarrow{\gamma} & \mathbb{T}^{\text{pre}} \end{array}$$

*Proof.* We make the following observations.

(1) By definition of the functor

$$\partial \mathcal{I} \xrightarrow{(2,2)} 1_{\text{Cat}} \sqcup 1_{\text{Cat}},$$

the following diagram in  $\text{Cat}$  commutes.

$$\begin{array}{ccc} 1_{\text{Cat}} & \xrightarrow{0} & \partial \mathcal{I} \\ & \searrow 2 & \downarrow (2,2) \\ & & 1_{\text{Cat}} \sqcup 1_{\text{Cat}} \end{array}$$

(2) By definition of the functor

$$1_{\text{Cat}} \sqcup 1_{\text{Cat}} \xrightarrow{1_{\mathbb{T}^{\text{pre}}} \sqcup 1_{\mathbb{T}^{\text{pre}}}} \mathbb{T}^{\text{pre}},$$

the following diagram in  $\mathbf{Cat}$  commutes.

$$\begin{array}{ccc} 1_{\mathbf{Cat}} & \xrightarrow{2} & 1_{\mathbf{Cat}} \sqcup 1_{\mathbf{Cat}} \\ & \searrow 1_{\mathbb{T}^{\text{pre}}} & \downarrow 1_{\mathbb{T}^{\text{pre}}} \sqcup 1_{\mathbb{T}^{\text{pre}}} \\ & & \mathbb{T}^{\text{pre}} \end{array}$$

(3) We deduce from (1) and (2) that the following diagram in  $\mathbf{Cat}$  commutes.

$$\begin{array}{ccc} 1_{\mathbf{Cat}} & \xrightarrow{0} & \partial\mathcal{I} \\ & \searrow 1_{\mathbb{T}^{\text{pre}}} & \downarrow (1_{\mathbb{T}^{\text{pre}}} \sqcup 1_{\mathbb{T}^{\text{pre}}}) \circ (2, 2) \\ & & \mathbb{T}^{\text{pre}} \end{array}$$

(4) By definition of the functor

$$\partial\mathcal{I} \xrightarrow{(0, 1)} \mathcal{I}$$

the following diagram in  $\mathbf{Cat}$  commutes.

$$\begin{array}{ccc} 1_{\mathbf{Cat}} & \xrightarrow{0} & \partial\mathcal{I} \\ & \searrow 0 & \downarrow (0, 1) \\ & & \mathcal{I} \end{array}$$

(5) By definition of the arrow  $\gamma$  of  $\mathbb{T}^{\text{pre}}$ , the following diagram in  $\mathbf{Cat}$  commutes.

$$\begin{array}{ccc} 1_{\mathbf{Cat}} & \xrightarrow{0} & \mathcal{I} \\ & \searrow 1_{\mathbb{T}^{\text{pre}}} & \downarrow \gamma \\ & & \mathbb{T}^{\text{pre}} \end{array}$$

(6) We deduce from (4) and (5) that the following diagram in  $\mathbf{Cat}$  commutes.

$$\begin{array}{ccc}
1_{\text{Cat}} & \xrightarrow{0} & \partial\mathcal{I} \\
& \searrow 1_{\mathbb{T}^{\text{pre}}} & \downarrow \gamma \circ (0, 1) \\
& & \mathbb{T}^{\text{pre}}
\end{array}$$

(7) We deduce from (3) and (6) that the following diagram in  $\text{Cat}$  commutes.

$$\begin{array}{ccc}
1_{\text{Cat}} & \xrightarrow{0} & \partial\mathcal{I} \\
0 \downarrow & & \downarrow (1_{\mathbb{T}^{\text{pre}}} \sqcup 1_{\mathbb{T}^{\text{pre}}}) \circ (2, 2) \\
\partial\mathcal{I} & \xrightarrow{\gamma \circ (0, 1)} & \mathbb{T}^{\text{pre}}
\end{array}$$

(8) By an entirely analogous argument to that of (1) – (7), the following diagram in  $\text{Cat}$  commutes.

$$\begin{array}{ccc}
1_{\text{Cat}} & \xrightarrow{1} & \partial\mathcal{I} \\
1 \downarrow & & \downarrow (1_{\mathbb{T}^{\text{pre}}} \sqcup 1_{\mathbb{T}^{\text{pre}}}) \circ (2, 2) \\
\partial\mathcal{I} & \xrightarrow{\gamma \circ (0, 1)} & \mathbb{T}^{\text{pre}}
\end{array}$$

(9) We deduce from (7) and (8) that the following diagram in  $\text{Cat}$  commutes, as required.

$$\begin{array}{ccc}
\partial\mathcal{I} & \xrightarrow{(2, 2)} & 1_{\text{Cat}} \sqcup 1_{\text{Cat}} \\
(0, 1) \downarrow & & \downarrow 1_{\mathbb{T}^{\text{pre}}} \sqcup 1_{\mathbb{T}^{\text{pre}}} \\
\mathcal{I} & \xrightarrow{\gamma} & \mathbb{T}^{\text{pre}}
\end{array}$$

□

**Notation 3.2.3.5.** Appealing to Proposition 3.2.3.4, let

$$\text{TL}_{\leq 2} \xrightarrow{\text{Tr}_{\leq 2}} \mathbb{T}^{\text{pre}}$$

denote the canonical functor such that the following diagram in  $\mathbf{Cat}$  commutes.

$$\begin{array}{ccc}
 \partial\mathcal{I} & \xrightarrow{(2,2)} & 1_{\mathbf{Cat}} \sqcup 1_{\mathbf{Cat}} \\
 \downarrow (0,1) & & \downarrow r_0^{\mathbf{TL}_{\leq 2}} \\
 \mathcal{I} & \xrightarrow{r_1^{\mathbf{TL}_{\leq 2}}} & \mathbf{TL}_{\leq 2} \\
 & \searrow \text{Tr}_{\leq 2} & \downarrow \\
 & & \mathbf{T}^{\text{pre}}
 \end{array}
 \begin{array}{l}
 \nearrow 1_{\mathbf{T}^{\text{pre}}} \sqcup 1_{\mathbf{T}^{\text{pre}}} \\
 \nearrow \gamma
 \end{array}$$

**Notation 3.2.3.6.** Let us denote by

$$\mathbf{T}^{\text{pre}} \xleftarrow{p_1^{\mathbf{T}^{\text{pre}}, bi}} \mathbf{T}^{\text{pre}} \times \mathbf{T}^{\text{pre}} \xrightarrow{p_2^{\mathbf{T}^{\text{pre}}, bi}} \mathbf{T}^{\text{pre}}$$

the diagram which is part of the data of  $\mathbf{T}^{\text{pre}}$ , and which defines a binary product.

**Proposition 3.2.3.7.** *The following diagram in  $\mathbf{Cat}$  commutes.*

$$\begin{array}{ccc}
 1_{\mathbf{Cat}} & \xrightarrow{(1,1)} & \mathbf{TL}_{\leq 2} \times \mathbf{TL}_{\leq 2} \\
 \downarrow 2 & & \downarrow \text{Tr}_{\leq 2} \times \text{Tr}_{\leq 2} \\
 & & \mathbf{T}^{\text{pre}} \times \mathbf{T}^{\text{pre}} \\
 & & \downarrow \otimes_{\mathbf{T}^{\text{pre}}} \\
 \mathbf{TL}_{\leq 2} & \xrightarrow{\text{Tr}_{\leq 2}} & \mathbf{T}^{\text{pre}}
 \end{array}$$

*Proof.* We make the following observations.

(1) By definition of  $\text{Tr}_{\leq 2} \times \text{Tr}_{\leq 2}$ , the following diagram in  $\mathbf{Cat}$  commutes.

$$\begin{array}{ccc}
 \mathbf{TL}_{\leq 2} \times \mathbf{TL}_{\leq 2} & \xrightarrow{\text{Tr}_{\leq 2} \times \text{Tr}_{\leq 2}} & \mathbf{T}^{\text{pre}} \times \mathbf{T}^{\text{pre}} \\
 \downarrow p_1^{\mathbf{TL}_{\leq 2}, bi} & & \downarrow p_1^{\mathbf{T}^{\text{pre}}, bi} \\
 \mathbf{TL}_{\leq 2} & \xrightarrow{\text{Tr}_{\leq 2}} & \mathbf{T}^{\text{pre}}
 \end{array}$$

(2) By definition of the functor  $(1, 1)$ , the following diagram in  $\mathbf{Cat}$  commutes.

$$\begin{array}{ccc}
 1_{\mathbf{Cat}} & \xrightarrow{(1, 1)} & \mathbf{TL}_{\leq 2} \times \mathbf{TL}_{\leq 2} \\
 & \searrow 1 & \downarrow p_1^{\mathbf{TL}_{\leq 2}, bi} \\
 & & \mathbf{TL}_{\leq 2}
 \end{array}$$

(3) By definition of the functor  $1$ , the following diagram in  $\mathbf{Cat}$  commutes.

$$\begin{array}{ccc}
 1_{\mathbf{Cat}} & & \\
 \downarrow 1 & \searrow 1 & \\
 1_{\mathbf{Cat}} \sqcup 1_{\mathbf{Cat}} & \xrightarrow{r_0^{\mathbf{TL}_{\leq 2}}} & \mathbf{TL}_{\leq 2}
 \end{array}$$

(4) We deduce from (2) and (3) that the following diagram in  $\mathbf{Cat}$  commutes.

$$\begin{array}{ccc}
 1_{\mathbf{Cat}} & \xrightarrow{(1, 1)} & \mathbf{TL}_{\leq 2} \times \mathbf{TL}_{\leq 2} \\
 \downarrow i_1^{1_{\mathbf{Cat}}} & & \downarrow p_1^{\mathbf{TL}_{\leq 2}, bi} \\
 1_{\mathbf{Cat}} \sqcup 1_{\mathbf{Cat}} & \xrightarrow{r_0^{\mathbf{TL}_{\leq 2}}} & \mathbf{TL}_{\leq 2}
 \end{array}$$

(5) We deduce from (1) and (4) that the following diagram in  $\mathbf{Cat}$  commutes.

$$\begin{array}{ccc}
 1_{\mathbf{Cat}} & \xrightarrow{(\mathbf{Tr}_{\leq 2} \times \mathbf{Tr}_{\leq 2}) \circ (1, 1)} & \mathbf{T}^{\text{pre}} \times \mathbf{T}^{\text{pre}} \\
 \downarrow 1 & & \downarrow p_1^{\mathbf{T}^{\text{pre}}, bi} \\
 1_{\mathbf{Cat}} \sqcup 1_{\mathbf{Cat}} & \xrightarrow{\mathbf{Tr}_{\leq 2} \circ r_0^{\mathbf{TL}_{\leq 2}}} & \mathbf{T}^{\text{pre}}
 \end{array}$$

(6) By definition of  $\mathbf{Tr}_{\leq 2}$ , we have that the following diagram in  $\mathbf{Cat}$  commutes.

$$\begin{array}{ccc}
1_{\text{Cat}} \sqcup 1_{\text{Cat}} & \xrightarrow{r_0^{\text{TL}_{\leq 2}}} & \text{TL}_{\leq 2} \\
& \searrow & \downarrow \text{Tr}_{\leq 2} \\
1_{\text{Tpre}} \sqcup 1_{\text{Tpre}} & & \text{Tpre}
\end{array}$$

(7) We deduce from (5) and (6) that the following diagram in  $\text{Cat}$  commutes.

$$\begin{array}{ccc}
1_{\text{Cat}} & \xrightarrow{(\text{Tr}_{\leq 2} \times \text{Tr}_{\leq 2}) \circ (1, 1)} & \text{Tpre} \times \text{Tpre} \\
\downarrow 1 & & \downarrow p_1^{\text{Tpre}, bi} \\
1_{\text{Cat}} \sqcup 1_{\text{Cat}} & \xrightarrow{1_{\text{Tpre}} \sqcup 1_{\text{Tpre}}} & \text{Tpre}
\end{array}$$

(8) By definition of the functor  $1_{\text{Tpre}} \sqcup 1_{\text{Tpre}}$ , we have that the following diagram in  $\text{Cat}$  commutes.

$$\begin{array}{ccc}
1_{\text{Cat}} & \xrightarrow{i_1^{1_{\text{Cat}}, bi}} & 1_{\text{Cat}} \sqcup 1_{\text{Cat}} \\
& \searrow 1_{\text{Tpre}} & \downarrow 1_{\text{Tpre}} \sqcup 1_{\text{Tpre}} \\
& & \text{Tpre}
\end{array}$$

(9) We deduce from (7) and (8) that the following diagram in  $\text{Cat}$  commutes.

$$\begin{array}{ccc}
1_{\text{Cat}} & \xrightarrow{(\text{Tr}_{\leq 2} \times \text{Tr}_{\leq 2}) \circ (1, 1)} & \text{Tpre} \times \text{Tpre} \\
& \searrow 1_{\text{Tpre}} & \downarrow p_1^{\text{Tpre}, bi} \\
& & \text{Tpre}
\end{array}$$

(10) By an entirely analogous argument to that of (1) – (9), we have that the following diagram in  $\text{Cat}$  commutes.

$$\begin{array}{ccc}
1_{\text{Cat}} & \xrightarrow{(\text{Tr}_{\leq 2} \times \text{Tr}_{\leq 2}) \circ (1, 1)} & \text{Tpre} \times \text{Tpre} \\
& \searrow 1_{\text{Tpre}} & \downarrow p_2^{\text{Tpre}, bi} \\
& & \text{Tpre}
\end{array}$$

(11) We deduce from (9), (10), and the universal property of  $\mathbb{T}^{\text{pre}} \times \mathbb{T}^{\text{pre}}$ , that the following diagram in  $\mathbf{Cat}$  commutes.

$$\begin{array}{ccc}
 1_{\mathbf{Cat}} & \xrightarrow{(1,1)} & \mathbb{T}L_{\leq 2} \times \mathbb{T}L_{\leq 2} \\
 & \searrow & \downarrow \text{Tr}_{\leq 2} \times \text{Tr}_{\leq 2} \\
 1_{\mathbb{T}^{\text{pre}}} \times 1_{\mathbb{T}^{\text{pre}}} & & \mathbb{T}^{\text{pre}} \times \mathbb{T}^{\text{pre}}
 \end{array}$$

(12) We deduce from (11) that the following diagram in  $\mathbf{Cat}$  commutes.

$$\begin{array}{ccc}
 1_{\mathbf{Cat}} & \xrightarrow{(1,1)} & \mathbb{T}L_{\leq 2} \times \mathbb{T}L_{\leq 2} \\
 \downarrow & & \downarrow \text{Tr}_{\leq 2} \times \text{Tr}_{\leq 2} \\
 1_{\mathbb{T}^{\text{pre}}} \times 1_{\mathbb{T}^{\text{pre}}} & & \mathbb{T}^{\text{pre}} \times \mathbb{T}^{\text{pre}} \\
 \downarrow & & \downarrow \otimes_{\mathbb{T}^{\text{pre}}} \\
 \mathbb{T}^{\text{pre}} \times \mathbb{T}^{\text{pre}} & \xrightarrow{\otimes_{\mathbb{T}^{\text{pre}}}} & \mathbb{T}^{\text{pre}}
 \end{array}$$

(13) By requirement (2) in Definition 2.1.1.3 with respect to  $(\mathbb{T}^{\text{pre}})^{\text{mult}}$ , we have that the following diagram in  $\mathbf{Cat}$  commutes.

$$\begin{array}{ccc}
 1_{\mathbf{Cat}} & \xrightarrow{1_{\mathbb{T}^{\text{pre}}} \times 1_{\mathbb{T}^{\text{pre}}}} & \mathbb{T}^{\text{pre}} \times \mathbb{T}^{\text{pre}} \\
 & \searrow & \downarrow \otimes_{\mathbb{T}^{\text{pre}}} \\
 & & \mathbb{T}^{\text{pre}}
 \end{array}$$

(14) We deduce from (12) and (13) that the following diagram in  $\mathbf{Cat}$  commutes.

$$\begin{array}{ccc}
 1_{\mathbf{Cat}} & \xrightarrow{(1,1)} & \mathbb{T}L_{\leq 2} \times \mathbb{T}L_{\leq 2} \\
 & \searrow & \downarrow \text{Tr}_{\leq 2} \times \text{Tr}_{\leq 2} \\
 & & \mathbb{T}^{\text{pre}} \times \mathbb{T}^{\text{pre}} \\
 & & \downarrow \otimes_{\mathbb{T}^{\text{pre}}} \\
 & & \mathbb{T}^{\text{pre}}
 \end{array}$$



(15) By definition of the functor  $2$ , we have that the following diagram in  $\text{Cat}$  commutes.

$$\begin{array}{ccc}
 1_{\text{Cat}} & & \\
 \downarrow 2 & \searrow 2 & \\
 1_{\text{Cat}} \sqcup 1_{\text{Cat}} & \xrightarrow{r_0^{\text{TL}_{\leq 2}}} & \text{TL}_{\leq 2}
 \end{array}$$

(16) We deduce from (16) that the following diagram in  $\text{Cat}$  commutes.

$$\begin{array}{ccc}
 1_{\text{Cat}} & \xrightarrow{2} & \text{TL}_{\leq 2} \\
 \downarrow 2 & & \downarrow \text{Tr}_{\leq 2} \\
 1_{\text{Cat}} \sqcup 1_{\text{Cat}} & \xrightarrow{\text{Tr}_{\leq 2} \circ r_0^{\text{TL}_{\leq 2}}} & \text{T}^{\text{pre}}
 \end{array}$$

(17) We deduce from (16) and (6) that the following diagram in  $\text{Cat}$  commutes.

$$\begin{array}{ccc}
 1_{\text{Cat}} & \xrightarrow{2} & \text{TL}_{\leq 2} \\
 \downarrow 2 & & \downarrow \text{Tr}_{\leq 2} \\
 1_{\text{Cat}} \sqcup 1_{\text{Cat}} & \xrightarrow{1_{\text{T}^{\text{pre}}} \sqcup 1_{\text{T}^{\text{pre}}}} & \text{T}^{\text{pre}}
 \end{array}$$

(18) By definition of the functor  $1_{\text{T}^{\text{pre}}} \sqcup 1_{\text{T}^{\text{pre}}}$ , we have that the following diagram in  $\text{Cat}$  commutes.

$$\begin{array}{ccc}
 1_{\text{Cat}} & \xrightarrow{2} & 1_{\text{Cat}} \sqcup 1_{\text{Cat}} \\
 \searrow 1_{\text{T}^{\text{pre}}} & & \downarrow 1_{\text{T}^{\text{pre}}} \sqcup 1_{\text{T}^{\text{pre}}} \\
 & & \text{T}^{\text{pre}}
 \end{array}$$

(19) We deduce from (17) and (18) that the following diagram in  $\text{Cat}$  commutes.

$$\begin{array}{ccc}
1_{\text{Cat}} & \xrightarrow{2} & \text{TL}_{\leq 2} \\
& \searrow 1_{\mathbb{T}^{\text{pre}}} & \downarrow \text{Tr}_{\leq 2} \\
& & \mathbb{T}^{\text{pre}}
\end{array}$$

(20) We conclude from (14) and (19) that the following diagram in  $\text{Cat}$  commutes, as required.

$$\begin{array}{ccc}
1_{\text{Cat}} & \xrightarrow{(1,1)} & \text{TL}_{\leq 2} \times \text{TL}_{\leq 2} \\
\downarrow 2 & & \downarrow \text{Tr}_{\leq 2} \times \text{Tr}_{\leq 2} \\
\text{TL}_{\leq 2} & \xrightarrow{\text{Tr}_{\leq 2}} & \mathbb{T}^{\text{pre}} \times \mathbb{T}^{\text{pre}} \\
& & \downarrow \otimes_{\mathbb{T}^{\text{pre}}} \\
& & \mathbb{T}^{\text{pre}}
\end{array}$$

□

**Corollary 3.2.3.8.** *The functor*

$$\text{TL}_{\leq 2} \xrightarrow{\text{Tr}_{\leq 2}} \mathbb{T}^{\text{pre}}$$

*exhibits  $\mathbb{M}_{\text{TL}}$  as a monoidal datum for  $\mathbb{T}^{\text{pre}}$ .*

*Proof.* Follows immediately from Proposition 3.2.3.7. □

**Notation 3.2.3.9.** Appealing to Corollary 3.2.3.8, let

$$\text{TL} \xrightarrow{\text{Tr}} \mathbb{T}^{\text{pre}}$$

denote the canonical functor of 2-rings to which the functor

$$\text{TL}_{\leq 2} \xrightarrow{\text{Tr}} \mathbb{T}^{\text{pre}}$$

gives rise, by means of the universal property of  $\text{TL}$ .

**Remark 3.2.3.10.** The idea of the construction of  $\text{Tr}$  is as follows.

- (1) The objects 1 and 2 of  $\text{TL}_{\leq 2}$  are sent to the unit object  $1_{\mathbb{T}^{\text{pre}}}$  for the multiplicative structure of  $\mathbb{T}^{\text{pre}}$ .

(2) The arrow

$$2 \xrightarrow{\text{CupAndCap}} 2$$

of  $\text{TL}_{\leq 2}$  is sent to

$$1_{\mathbb{T}^{\text{pre}}} \xrightarrow{\gamma} 1_{\mathbb{T}^{\text{pre}}}.$$

(3) We extend freely to all of  $\text{TL}_{\leq 2}$ . Thus, for instance, the arrow

$$2 \xrightarrow{\text{CupAndCap} \circ \text{CupAndCap}} 2$$

of  $\text{TL}$  is sent to the arrow

$$1_{\mathbb{T}^{\text{pre}}} \xrightarrow{\gamma \circ \gamma} 1_{\mathbb{T}^{\text{pre}}},$$

of  $\mathbb{T}^{\text{pre}}$  which, appealing to Proposition 2.1.3.20, is equal to the arrow

$$1_{\mathbb{T}^{\text{pre}}} \xrightarrow{\gamma \otimes_{\mathbb{T}^{\text{pre}}} \gamma} 1_{\mathbb{T}^{\text{pre}}},$$

of  $\mathbb{T}^{\text{pre}}$ , or

$$1_{\mathbb{T}^{\text{pre}}} \xrightarrow{\gamma^2} 1_{\mathbb{T}^{\text{pre}}},$$

for short.

(4) We extend freely to all of  $\text{TL}$ . Thus, for instance, the arrow

$$(\text{CupAndCap} \otimes_{\text{TL}} id(1)) \oplus_{\text{TL}} (\text{CupAndCap} \circ \text{CupAndCap})$$

of  $\text{TL}$  is sent to the arrow

$$(\gamma \otimes_{\mathbb{T}^{\text{pre}}} id(1_{\mathbb{T}^{\text{pre}}})) \oplus_{\mathbb{T}^{\text{pre}}} \gamma^2,$$

or, in other words,

$$\gamma \oplus_{\mathbb{T}^{\text{pre}}} \gamma^2.$$

**Notation 3.2.3.11.** Let

$$\mathrm{TL}(\mathbb{S})^{\mathrm{pre}} \xrightarrow{\mathrm{Tr}^{\mathbb{S},\mathrm{pre}}} \mathbb{T}^{\mathrm{pre}}$$

denote the canonical 2-ring functor such that the following diagram in  $\mathrm{Ring}(\mathrm{Cat})$  commutes.

$$\begin{array}{ccccc} \mathbb{R} & \xrightarrow{i_1^{\cdot\mathrm{TL}(\mathbb{S})^{\mathrm{pre}},bi}} & \mathrm{TL}(\mathbb{S})^{\mathrm{pre}} & \xleftarrow{i_2^{\cdot\mathrm{TL}(\mathbb{S})^{\mathrm{pre}},bi}} & \mathrm{TL} \\ & \searrow t & \downarrow \mathrm{Tr}^{\mathbb{S},\mathrm{pre}} & \swarrow \mathrm{Tr} & \\ & & \mathbb{T}^{\mathrm{pre}} & & \end{array}$$

**Terminology 3.2.3.12.** We refer to

$$\mathrm{TL}(\mathbb{S})^{\mathrm{pre}} \xrightarrow{\mathrm{Tr}^{\mathbb{S},\mathrm{pre}}} \mathbb{T}^{\mathrm{pre}}$$

as the *pre-Markov trace functor* associated to  $\mathbb{T}$ .

**Remark 3.2.3.13.** The idea of the construction of  $\mathrm{Tr}^{\mathbb{S},\mathrm{pre}}$  is that we extend  $\mathrm{Tr}$  linearly. Thus, for instance, the arrow

$$(A \otimes_{\mathrm{TL}(\mathbb{S})} (id(1) \otimes_{\mathrm{TL}(\mathbb{S})} \mathrm{CupAndCap})) \oplus_{\mathrm{TL}(\mathbb{S})} (B \otimes_{\mathrm{TL}(\mathbb{S})} \mathrm{CupAndCap})$$

of  $\mathrm{TL}(\mathbb{S})$  is sent to

$$(t(A) \otimes_{\mathbb{T}^{\mathrm{pre}}} (id(1_{\mathbb{T}^{\mathrm{pre}}} \otimes_{\mathbb{T}^{\mathrm{pre}}} \gamma)) \oplus_{\mathbb{T}^{\mathrm{pre}}} (t(B) \otimes_{\mathrm{TL}(\mathbb{S})} \gamma),$$

or, in other words, to

$$(t(A) \oplus_{\mathbb{T}^{\mathrm{pre}}} t(B)) \otimes_{\mathbb{T}^{\mathrm{pre}}} \gamma.$$

**Notation 3.2.3.14.** Let us denote by

$$\mathrm{F}_{2\text{-ring}}(1_{\mathrm{Cat}}) \xrightarrow{1_{\mathbb{T}^{\mathrm{pre}}}} \mathbb{T}^{\mathrm{pre}}$$

the canonical functor of 2-rings to which the functor

$$1_{\mathrm{Cat}} \xrightarrow{1_{\mathbb{T}^{\mathrm{pre}}}} \mathbb{T}^{\mathrm{pre}}$$

gives rise, by means of the universal property of  $\mathrm{F}_{2\text{-ring}}(1_{\mathrm{Cat}})$ .

**Notation 3.2.3.15.** Let us denote by

$$\partial\mathcal{I} \xrightarrow{\mathrm{Tr}^{\mathbb{S},\mathrm{pre}}(a_0 \oplus b_0) \sqcup \mathrm{Tr}^{\mathbb{S},\mathrm{pre}}(a_1 \oplus b_1)} \mathbb{T}^{\mathrm{pre}}$$

the canonical functor determined by the pair of objects  $\mathrm{Tr}^{\mathbb{S},\mathrm{pre}}(a_0 \oplus b_0)$  and  $\mathrm{Tr}^{\mathbb{S},\mathrm{pre}}(a_1 \oplus b_1)$  of  $\mathbb{T}^{\mathrm{pre}}$ .

**Notation 3.2.3.16.** Let us denote by

$$\mathrm{F}_{2\text{-ring}}(\partial\mathcal{I}) \xrightarrow{\mathrm{Tr}^{\mathbb{S},\mathrm{pre}}(a_0 \oplus b_0) \sqcup \mathrm{Tr}^{\mathbb{S},\mathrm{pre}}(a_1 \oplus b_1)} \mathbb{T}^{\mathrm{pre}}$$

the canonical functor of 2-rings to which the functor

$$\partial\mathcal{I} \xrightarrow{\mathrm{Tr}^{\mathbb{S},\mathrm{pre}}(a_0 \oplus b_0) \sqcup \mathrm{Tr}^{\mathbb{S},\mathrm{pre}}(a_1 \oplus b_1)} \mathbb{T}^{\mathrm{pre}}$$

gives rise by means of the universal property of  $\mathrm{F}_{2\text{-ring}}(\partial\mathcal{I})$ .

**Notation 3.2.3.17.** Let us denote by

$$\partial\mathcal{I} \xrightarrow{(1_{\mathbb{T}^{\mathrm{pre}}}, 1_{\mathbb{T}^{\mathrm{pre}}})} \mathbb{T}^{\mathrm{pre}}$$

the functor determined by the pair  $(1_{\mathbb{T}^{\mathrm{pre}}}, 1_{\mathbb{T}^{\mathrm{pre}}})$  of objects of  $\mathbb{T}^{\mathrm{pre}}$ .

**Notation 3.2.3.18.** Let us denote by

$$\mathrm{F}_{2\text{-ring}}(\partial\mathcal{I}) \xrightarrow{(1_{\mathbb{T}^{\mathrm{pre}}}, 1_{\mathbb{T}^{\mathrm{pre}}})} \mathbb{T}^{\mathrm{pre}}$$

the canonical functor of 2-rings to which the functor

$$\partial\mathcal{I} \xrightarrow{(1_{\mathbb{T}^{\mathrm{pre}}}, 1_{\mathbb{T}^{\mathrm{pre}}})} \mathbb{T}^{\mathrm{pre}}$$

gives rise by means of the universal property of  $\mathrm{F}_{2\text{-ring}}(\partial\mathcal{I})$ .

**Notation 3.2.3.19.** Appealing to Fact 2.1.3.16, let

$$\mathrm{F}_{2\text{-ring}}(\partial\mathcal{I}) \begin{array}{c} \xrightarrow{\mathrm{Tr}^{\mathbb{S},\mathrm{pre}}(a_0 \oplus b_0) \sqcup \mathrm{Tr}^{\mathbb{S},\mathrm{pre}}(a_1 \oplus b_1)} \\ \xrightarrow{(1_{\mathbb{T}^{\mathrm{pre}}}, 1_{\mathbb{T}^{\mathrm{pre}}})} \end{array} \mathbb{T}^{\mathrm{pre}} \xrightarrow{\mathrm{can}_{\mathbb{T}}} \mathbb{T}$$

be a coequaliser diagram in  $\mathrm{Ring}(\mathrm{Cat})$ .

**Remark 3.2.3.20.** The idea of the construction of  $\mathbb{T}$  from  $\mathbb{T}^{\text{pre}}$  is that we identify both of the objects  $\text{Tr}^{\mathbb{S},\text{pre}}(a_0 \oplus a_1)$  and  $\text{Tr}^{\mathbb{S},\text{pre}}(b_0 \oplus b_1)$  of  $\mathbb{T}^{\text{pre}}$  with the object  $1_{\mathbb{T}^{\text{pre}}}$  of  $\mathbb{T}^{\text{pre}}$ . The purpose of this is to ensure that the functor of 2-rings

$$\text{TL}(\mathbb{S})^{\text{pre}} \xrightarrow{\text{Tr}^{\mathbb{S},\text{pre}}} \mathbb{T}^{\text{pre}}$$

extends to a functor from

$$\text{TL}(\mathbb{S}) \longrightarrow \mathbb{T},$$

in the manner we shall now describe.

**Proposition 3.2.3.21.** *The following diagram in  $\text{Cat}$  commutes.*

$$\begin{array}{ccc} 1_{\text{Cat}} & \xrightarrow{(a_0 \otimes 2) \oplus (b_0 \otimes 2)} & \text{TL}(\mathbb{S})^{\text{pre}} \\ \downarrow 2 & & \downarrow \text{can}_{\mathbb{T}} \circ \text{Tr}^{\mathbb{S},\text{pre}} \\ \text{TL}(\mathbb{S})^{\text{pre}} & \xrightarrow{\text{can}_{\mathbb{T}} \circ \text{Tr}^{\mathbb{S},\text{pre}}} & \mathbb{T} \end{array}$$

*Proof.* We make the following observations.

(1) Since  $\text{Tr}^{\mathbb{S},\text{pre}}$  is a functor of 2-rings, the following diagram in  $\text{Cat}$  commutes.

$$\begin{array}{ccc} 1_{\text{Cat}} & \xrightarrow{(a_0 \otimes 2) \oplus (b_0 \otimes 2)} & \text{TL}(\mathbb{S})^{\text{pre}} \\ & \searrow & \downarrow \text{Tr}^{\mathbb{S},\text{pre}} \\ (\text{Tr}^{\mathbb{S},\text{pre}}(a_0) \otimes \text{Tr}^{\mathbb{S},\text{pre}}(2)) \oplus (\text{Tr}^{\mathbb{S},\text{pre}}(b_0) \otimes \text{Tr}^{\mathbb{S},\text{pre}}(2)) & & \mathbb{T}^{\text{pre}} \end{array}$$

(2) By definition of  $\text{Tr}^{\mathbb{S},\text{pre}}$ , we have that  $\text{Tr}^{\mathbb{S},\text{pre}}(2)$  is equal to  $1_{\mathbb{T}^{\text{pre}}}$ . We deduce from (1) that the diagram

$$\begin{array}{ccc} 1_{\text{Cat}} & \xrightarrow{(a_0 \otimes 2) \oplus (b_0 \otimes 2)} & \text{TL}(\mathbb{S})^{\text{pre}} \\ & \searrow & \downarrow \text{Tr}^{\mathbb{S},\text{pre}} \\ (\text{Tr}^{\mathbb{S},\text{pre}}(a_0) \otimes 1_{\mathbb{T}^{\text{pre}}}) \oplus (\text{Tr}^{\mathbb{S},\text{pre}}(b_0) \otimes 1_{\mathbb{T}^{\text{pre}}}) & & \mathbb{T}^{\text{pre}} \end{array}$$

in  $\text{Cat}$  commutes, and hence that the following diagram in  $\text{Cat}$  commutes.

$$\begin{array}{ccc}
1_{\text{Cat}} & \xrightarrow{(a_0 \otimes 2) \oplus (b_0 \otimes 2)} & \text{TL}(\mathbb{S})^{\text{pre}} \\
& \searrow & \downarrow \text{Tr}^{\mathbb{S}, \text{pre}} \\
\text{Tr}^{\mathbb{S}, \text{pre}}(a_0) \oplus \text{Tr}^{\mathbb{S}, \text{pre}}(b_0) & & \text{T}^{\text{pre}}
\end{array}$$

(3) Appealing again to the fact that  $\text{Tr}^{\mathbb{S}, \text{pre}}$  is a functor of 2-rings, we deduce from (2) that the following diagram in  $\text{Cat}$  commutes.

$$\begin{array}{ccc}
1_{\text{Cat}} & \xrightarrow{(a_0 \otimes 2) \oplus (b_0 \otimes 2)} & \text{TL}(\mathbb{S})^{\text{pre}} \\
& \searrow & \downarrow \text{Tr}^{\mathbb{S}, \text{pre}} \\
\text{Tr}^{\mathbb{S}, \text{pre}}(a_0 \oplus b_0) & & \text{T}^{\text{pre}}
\end{array}$$

(4) By definition of  $\text{T}$ , we have that the following diagram in  $\text{Cat}$  commutes.

$$\begin{array}{ccc}
1_{\text{Cat}} & \xrightarrow{\text{Tr}^{\mathbb{S}, \text{pre}}(a_0 \oplus b_0)} & \text{T}^{\text{pre}} \\
& \searrow & \downarrow \text{can}_{\text{T}} \\
& & \text{T} \\
& \searrow \text{can}_{\text{T}} \circ 1_{\text{T}^{\text{pre}}} & \\
& & \text{T}
\end{array}$$

(5) Since  $\text{can}_{\text{T}}$  is a functor of 2-rings, we deduce from (4) that the following diagram in  $\text{Cat}$  commutes.

$$\begin{array}{ccc}
1_{\text{Cat}} & \xrightarrow{\text{Tr}^{\mathbb{S}, \text{pre}}(a_0 \oplus b_0)} & \text{T}^{\text{pre}} \\
& \searrow & \downarrow \text{can}_{\text{T}} \\
& & \text{T} \\
& \searrow 1_{\text{T}} & \\
& & \text{T}
\end{array}$$

(6) We deduce from (3) and (5) that the following diagram in  $\text{Cat}$  commutes.

$$\begin{array}{ccc}
1_{\text{Cat}} & \xrightarrow{(a_0 \otimes 2) \oplus (b_0 \otimes 2)} & \text{TL}(\mathbb{S})^{\text{pre}} \\
& \searrow 1_{\mathbb{T}} & \downarrow \text{Tr}^{\mathbb{S}, \text{pre}} \\
& & \mathbb{T}^{\text{pre}} \\
& & \downarrow \text{can}_{\mathbb{T}} \\
& & \mathbb{T}
\end{array}$$

(7) Appealing again to the fact that  $\text{Tr}^{\mathbb{S}, \text{pre}}(2)$  is equal to  $1_{\mathbb{T}^{\text{pre}}}$ , and to the fact that  $\text{can}_{\mathbb{T}}$  is a functor of 2-rings, we have that the following diagram in  $\text{Cat}$  commutes.

$$\begin{array}{ccc}
1_{\text{Cat}} & \xrightarrow{2} & \text{TL}(\mathbb{S})^{\text{pre}} \\
& \searrow 1_{\mathbb{T}} & \downarrow \text{can}_{\mathbb{T}} \circ \text{Tr}^{\mathbb{S}, \text{pre}} \\
& & \mathbb{T}
\end{array}$$

(8) We deduce from (6) and (7) that the following diagram in  $\text{Cat}$  commutes, as required.

$$\begin{array}{ccc}
1_{\text{Cat}} & \xrightarrow{(a_0 \otimes 2) \oplus (b_0 \otimes 2)} & \text{TL}(\mathbb{S})^{\text{pre}} \\
\downarrow 2 & & \downarrow \text{can}_{\mathbb{T}} \circ \text{Tr}^{\mathbb{S}, \text{pre}} \\
\text{TL}(\mathbb{S})^{\text{pre}} & \xrightarrow{\text{can}_{\mathbb{T}} \circ \text{Tr}^{\mathbb{S}, \text{pre}}} & \mathbb{T}
\end{array}$$

□

**Proposition 3.2.3.22.** *The following diagram in  $\text{Cat}$  commutes.*

$$\begin{array}{ccc}
1_{\text{Cat}} & \xrightarrow{(a_1 \otimes 2) \oplus (b_1 \otimes 2)} & \text{TL}(\mathbb{S})^{\text{pre}} \\
\downarrow 2 & & \downarrow \text{can}_{\mathbb{T}} \circ \text{Tr}^{\mathbb{S}, \text{pre}} \\
\text{TL}(\mathbb{S})^{\text{pre}} & \xrightarrow{\text{can}_{\mathbb{T}} \circ \text{Tr}^{\mathbb{S}, \text{pre}}} & \mathbb{T}
\end{array}$$

*Proof.* Entirely analogous to the proof of Proposition 3.2.3.21.

□



**Corollary 3.2.3.23.** *The following diagram in  $\text{Ring}(\text{Cat})$  commutes.*

$$\begin{array}{ccc}
 F_{2\text{-ring}}(\partial\mathcal{I}) & \xrightarrow{((a_0 \otimes 2) \oplus (b_0 \otimes 2)) \sqcup ((a_1 \otimes 2) \oplus (b_1 \otimes 2))} & \text{TL}(\mathbb{S})^{\text{pre}} \\
 (2, 2) \downarrow & & \downarrow \text{can}_{\mathbb{T}} \circ \text{Tr}^{\mathbb{S}, \text{pre}} \\
 \text{TL}(\mathbb{S})^{\text{pre}} & \xrightarrow{\text{can}_{\mathbb{T}} \circ \text{Tr}^{\mathbb{S}, \text{pre}}} & \mathbb{T}
 \end{array}$$

*Proof.* It follows immediately from Proposition 3.2.3.21 and Proposition 3.2.3.22 that the following diagram in  $\text{Cat}$  commutes.

$$\begin{array}{ccc}
 \partial\mathcal{I} & \xrightarrow{((a_0 \otimes 2) \oplus (b_0 \otimes 2)) \sqcup ((a_1 \otimes 2) \oplus (b_1 \otimes 2))} & \text{TL}(\mathbb{S})^{\text{pre}} \\
 (2, 2) \downarrow & & \downarrow \text{can}_{\mathbb{T}} \circ \text{Tr}^{\mathbb{S}, \text{pre}} \\
 \text{TL}(\mathbb{S})^{\text{pre}} & \xrightarrow{\text{can}_{\mathbb{T}} \circ \text{Tr}^{\mathbb{S}, \text{pre}}} & \mathbb{T}
 \end{array}$$

Appealing to the universal property of  $F_{2\text{-ring}}(\partial\mathcal{I})$ , we deduce that the following diagram in  $\text{Ring}(\text{Cat})$  commutes, as required.

$$\begin{array}{ccc}
 F_{2\text{-ring}}(\partial\mathcal{I}) & \xrightarrow{((a_0 \otimes 2) \oplus (b_0 \otimes 2)) \sqcup ((a_1 \otimes 2) \oplus (b_1 \otimes 2))} & \text{TL}(\mathbb{S})^{\text{pre}} \\
 (2, 2) \downarrow & & \downarrow \text{can}_{\mathbb{T}} \circ \text{Tr}^{\mathbb{S}, \text{pre}} \\
 \text{TL}(\mathbb{S})^{\text{pre}} & \xrightarrow{\text{can}_{\mathbb{T}} \circ \text{Tr}^{\mathbb{S}, \text{pre}}} & \mathbb{T}
 \end{array}$$

□

**Notation 3.2.3.24.** Appealing to Corollary , let

$$\text{TL}(\mathbb{S}) \xrightarrow{\text{Tr}^{\mathbb{S}}} \mathbb{T}$$

denote the canonical functor of 2-rings such that the following diagram in  $\text{Ring}(\text{Cat})$  commutes.

$$\begin{array}{ccc}
 \text{TL}(\mathbb{S})^{\text{pre}} & \xrightarrow{\text{can}_{\text{TL}(\mathbb{S})}} & \text{TL}(\mathbb{S}) \\
 & \searrow \text{Tr}^{\mathbb{S}, \text{pre}} & \downarrow \text{Tr}^{\mathbb{S}} \\
 & & \mathbb{T}
 \end{array}$$

**Terminology 3.2.3.25.** We refer to  $\text{Tr}^{\mathbb{S}}$  as the *Markov trace functor* with respect to  $\mathbb{T}$ .

**Remark 3.2.3.26.** Let  $\mathbb{R}$  and  $\mathbb{R}[A, B]$  be the 2-rings of Remark 3.2.2.20, and let  $\mathbb{S}$  be the datum for smoothing of braids defined of Remark 3.2.2.20. Let  $\mathbb{R}[A, B, \gamma]$  be the 2-ring constructed from  $\mathbb{R}[A, B]$  by formally adding an endomorphism  $\gamma$  of the multiplicative unit  $1_{\mathbb{R}}$ . This construction is carried out formally in §3.2.5. The arrows of  $\mathbb{R}[A, B, \gamma]$  are exactly those of the coproduct  $\bigsqcup_{n \geq 0} \mathbb{N}[A, B, \gamma]$  in  $\text{Cat}$  of one copy of  $\mathbb{N}[A, B, \gamma]$  for each natural number.

Let  $\mathbb{T}$  be the Markov trace datum given by  $(\mathbb{R}[A, B, \gamma], \gamma, \text{can}_{\mathbb{R}[A, B, \gamma]})$ , where

$$\mathbb{R}[A, B] \xrightarrow{\text{can}_{\mathbb{R}[A, B, \gamma]}} \mathbb{R}[A, B, \gamma]$$

is the canonical functor of 2-rings. Then the Markov trace functor

$$\text{TL}(\mathbb{S}) \xrightarrow{\text{Tr}^{\mathbb{S}}} \mathbb{T}$$

with respect to  $\mathbb{T}$  almost agrees, on arrows, with the usual Markov trace morphisms

$$\mathcal{TL}_n \longrightarrow \mathbb{N}[A, B, \gamma]$$

discussed for instance in the remark after Proposition 3.6 in [13], albeit for a quotient of  $\mathbb{N}[A, B, \gamma]$ . In the literature,  $\gamma$  is usually assumed to be invertible. Our Markov trace functor is obtained exactly from the usual Markov trace morphisms

$$\mathcal{TL}_n \longrightarrow \mathbb{N}[A, B, \gamma, \gamma^{-1}]$$

if all uses of  $\gamma^{-1}$  are replaced by uses of  $\gamma$ .

### 3.2.4. Constructing a datum for smoothing of braids given a 2-ring

**Notation 3.2.4.1.** Appealing to Fact 2.2.2.2, let  $\mathbb{F}_{2\text{-ring}}[A, B]$  denote the free 2-ring on  $\mathcal{I} \sqcup \mathcal{I}$ . We denote the canonical functor

$$\mathcal{I} \sqcup \mathcal{I} \longrightarrow \mathbb{F}_{2\text{-ring}}[A, B]$$

by  $\text{can}_{\mathbb{F}_{2\text{-ring}}[A, B]}$ .

**Notation 3.2.4.2.** We shall also denote by  $\mathbb{R}[A, B]$  the category which is part of the data of  $\mathbb{R}[A, B]$ .

**Notation 3.2.4.3.** Appealing to Fact 2.1.3.16, let

$$\mathbb{R} \xrightarrow{i_1^{\mathbb{R}[A,B],bi}} \mathbb{R}[A, B] \xleftarrow{i_2^{\mathbb{R}[A,B],bi}} \mathbb{F}_{2\text{-ring}}[A, B]$$

be a binary coproduct in  $\text{Ring}(\text{Cat})$ .

**Notation 3.2.4.4.** We denote by  $A$  the arrow of  $\mathbb{R}[A, B]$  corresponding to the functor

$$\mathcal{I} \xrightarrow{i_2^{\mathbb{R}[A,B],bi} \circ \text{can}_{\mathbb{F}_{2\text{-ring}}[A,B]} \circ i_1^{\mathcal{I},bi}} \mathbb{R}[A, B]$$

**Notation 3.2.4.5.** We denote by  $B$  the arrow of  $\mathbb{R}[A, B]$  corresponding to the functor

$$\mathcal{I} \xrightarrow{i_2^{\mathbb{R}[A,B],bi} \circ \text{can}_{\mathbb{F}_{2\text{-ring}}[A,B]} \circ i_2^{\mathcal{I},bi}} \mathbb{R}[A, B]$$

**Remark 3.2.4.6.** The idea of the construction of  $\mathbb{R}[A, B]$  is as follows.

- (1) We add an arrow  $A$  to  $\mathbb{R}$ , along with a pair of objects which are its source and target.
- (2) We add an arrow  $B$  to  $\mathbb{R}$ , along with a pair of objects which are its source and target.
- (3) We add exactly those objects and arrows to  $\mathbb{R}$  which are needed to have a 2-ring. The arrows added can be thought of as all non-commutative polynomials, with coefficients in  $\mathbb{R}$ , in the variables  $A$  and  $B$ . The objects added can be thought of as all non-commutative polynomials, with coefficients in  $\mathbb{R}$ , in four variables, corresponding to the four objects added to  $\mathbb{R}$ , namely the source and target of  $A$  and the source and target of  $B$ .

**Remark 3.2.4.7.** We have that  $(\mathbb{R}[A, B], A, B)$  defines a datum for smoothing of braids. In fact, this datum is universal amongst data for smoothing of braids constructed from  $\mathbb{R}$ . We shall not, however, need this universal property, and shall omit its precise statement and a proof.

### 3.2.5. Constructing a Markov trace datum given a 2-ring

**Notation 3.2.5.1.** Let

$$1_{\text{Cat}} \sqcup 1_{\text{Cat}} \xrightarrow{p} 1_{\text{Cat}}$$

be the canonical functor.

**Notation 3.2.5.2.** Let

$$\begin{array}{ccc}
 1_{\text{Cat}} \sqcup 1_{\text{Cat}} & \xrightarrow{p} & 1_{\text{Cat}} \\
 \downarrow 0 \sqcup 1 & & \downarrow r_0^{\mathcal{F}[\gamma]} \\
 \mathcal{I} & \xrightarrow{r_1^{\mathcal{F}[\gamma]}} & \mathcal{F}[\gamma]
 \end{array}$$

be a co-cartesian square in  $\text{Cat}$ .

**Notation 3.2.5.3.** We denote by  $\gamma$  the arrow of  $\mathcal{F}[\gamma]$  corresponding to the functor

$$\mathcal{I} \xrightarrow{r_1^{\mathcal{F}[\gamma]}} \mathcal{F}[\gamma].$$

**Remark 3.2.5.4.** The definition of  $\mathcal{F}[\gamma]$  can be thought of as follows. We begin with a category consisting of exactly one object, which we denote by 1, and no non-identity arrows. We then proceed as follows.

(1) We add an arrow

$$1 \longrightarrow 1,$$

which we denote by  $\gamma$ .

(2) We then add exactly those further arrows

$$1 \longrightarrow 1$$

that we need to have a category, namely arbitrary finite compositions of  $\gamma$  with itself.

**Notation 3.2.5.5.** Appealing to Fact 2.2.2.2, let  $F_{2\text{-ring}}[\gamma]$  denote the free 2-ring on  $\mathcal{F}[\gamma]$ . We denote the canonical functor

$$\mathcal{F}[\gamma] \longrightarrow F_{2\text{-ring}}[\gamma]$$

by  $\text{can}_{F_{2\text{-ring}}[\gamma]}$ .

**Notation 3.2.5.6.** Appealing to Fact 2.2.2.2, we denote by  $F_{2\text{-ring}}(1_{\text{Cat}})$  the free 2-ring on  $1_{\text{Cat}}$ .

**Notation 3.2.5.7.** Let

$$\mathbf{F}_{2\text{-Ring}}(1_{\text{Cat}}) \xrightarrow{1_{\mathbf{R}}} \mathbf{R}$$

be the canonical functor of 2-rings to which the functor

$$1_{\text{Cat}} \xrightarrow{1_{\mathbf{R}}} \mathbf{R}$$

gives rise by means of the universal property of  $\mathbf{F}_{2\text{-Ring}}(1_{\text{Cat}})$ .

**Notation 3.2.5.8.** Let

$$\mathbf{F}_{2\text{-Ring}}(1_{\text{Cat}}) \xrightarrow{g} \mathbf{F}_{2\text{-ring}}[\gamma]$$

be the canonical functor to which the functor

$$1_{\text{Cat}} \xrightarrow{\text{can}_{\mathbf{F}_{2\text{-ring}}[\gamma]} \circ r_0^{\mathcal{F}[\gamma]}} \mathbf{F}_{2\text{-ring}}[\gamma]$$

gives rise by means of the universal property of  $\mathbf{F}_{2\text{-Ring}}(1_{\text{Cat}})$ .

**Notation 3.2.5.9.** Appealing to Fact 2.1.3.16, let

$$\begin{array}{ccc} \mathbf{F}_{2\text{-Ring}}(1_{\text{Cat}}) & \xrightarrow{g} & \mathbf{F}_{2\text{-ring}}[\gamma] \\ \downarrow 1_{\mathbf{R}} & & \downarrow r_0^{\mathbf{R}[\gamma]} \\ \mathbf{R} & \xrightarrow{r_1^{\mathbf{R}[\gamma]}} & \mathbf{R}[\gamma] \end{array}$$

be a co-cartesian square in  $\text{Ring}(\text{Cat})$ .

**Notation 3.2.5.10.** Let

$$\mathbf{F}_{2\text{-Ring}}(1_{\text{Cat}}) \xrightarrow{1_{\mathbf{R}}} \mathbf{R}$$

be the canonical functor of 2-rings to which the functor

$$1_{\text{Cat}} \xrightarrow{1_{\mathbf{R}}} \mathbf{R}$$

gives rise by means of the universal property of  $\mathbf{F}_{2\text{-Ring}}(1_{\text{Cat}})$ .

**Notation 3.2.5.11.** Let

$$\mathbf{F}_{2\text{-Ring}}(1_{\text{Cat}}) \xrightarrow{g} \mathbf{F}_{2\text{-ring}}[\gamma]$$

be the canonical functor to which the functor

$$1_{\text{Cat}} \xrightarrow{\text{can}_{\mathbb{F}_2\text{-ring}[\gamma]} \circ r_0^{\mathcal{F}[\gamma]}} \mathbb{F}_2\text{-ring}[\gamma]$$

gives rise by means of the universal property of  $\mathbb{F}_2\text{-Ring}(1_{\text{Cat}})$ .

**Notation 3.2.5.12.** Appealing to Fact 2.1.3.16, let

$$\begin{array}{ccc} \mathbb{F}_2\text{-Ring}(1_{\text{Cat}}) & \xrightarrow{g} & \mathbb{F}_2\text{-ring}[\gamma] \\ 1_{\mathbb{R}} \downarrow & & \downarrow r_0^{\mathbb{R}[\gamma]} \\ \mathbb{R} & \xrightarrow{r_1^{\mathbb{R}[\gamma]}} & \mathbb{R}[\gamma] \end{array}$$

be a co-cartesian square in  $\text{Ring}(\text{Cat})$ .

**Notation 3.2.5.13.** We denote by  $\gamma$  the arrow of  $\mathbb{R}[\gamma]$  corresponding to the functor

$$\mathcal{I} \xrightarrow{r_0^{\mathbb{R}[\gamma]} \circ \text{can}_{\mathbb{F}_2\text{-ring}[\gamma]} \circ \gamma} \mathbb{R}[\gamma]$$

**Remark 3.2.5.14.** The idea of the construction of  $\mathbb{R}[\gamma]$  is that we identify the single object of  $\mathcal{F}[\gamma]$ , viewed as an object of  $\mathbb{F}_2\text{-ring}[\gamma]$  via the functor  $\text{can}_{\mathbb{F}_2\text{-ring}[\gamma]}$ , with the unit  $1_{\mathbb{R}}$  of  $\mathbb{R}^{\text{mult}}$ . Thus  $\gamma$  becomes an endomorphism of  $1_{\mathbb{R}}$ . We now express this formally.

**Proposition 3.2.5.15.** *The following diagram in  $\text{Cat}$  commutes.*

$$\begin{array}{ccc} 1_{\text{Cat}} & \xrightarrow{0} & \mathcal{I} \\ & \searrow 1_{\mathbb{R}[\gamma]} & \downarrow \gamma \\ & & \mathbb{R}[\gamma] \end{array}$$

*Proof.* We make the following observations.

(1) By definition of the functor

$$1_{\text{Cat}} \sqcup 1_{\text{Cat}} \xrightarrow{0 \sqcup 1} \mathcal{I},$$

the following diagram in  $\text{Cat}$  commutes.

$$\begin{array}{ccc}
1_{\text{Cat}} & & \\
i_1^{1_{\text{Cat}}, bi} \downarrow & \searrow 0 & \\
1_{\text{Cat}} \sqcup 1_{\text{Cat}} & \xrightarrow{0 \sqcup 1} & \mathcal{I}
\end{array}$$

(2) By definition of  $\mathcal{F}[\gamma]$ , the following diagram in  $\text{Cat}$  commutes.

$$\begin{array}{ccc}
1_{\text{Cat}} \sqcup 1_{\text{Cat}} & \xrightarrow{p} & 1_{\text{Cat}} \\
0 \sqcup 1 \downarrow & & \downarrow r_0^{\mathcal{F}[\gamma]} \\
\mathcal{I} & \xrightarrow{r_1^{\mathcal{F}[\gamma]}} & \mathcal{F}[\gamma]
\end{array}$$

(3) We deduce from (1) and (2) that the following diagram in  $\text{Cat}$  commutes.

$$\begin{array}{ccc}
1_{\text{Cat}} & \xrightarrow{0} & \mathcal{I} \\
p \circ i_1^{1_{\text{Cat}}, bi} \downarrow & & \downarrow r_1^{\mathcal{F}[\gamma]} \\
1_{\text{Cat}} & \xrightarrow{r_0^{\mathcal{F}[\gamma]}} & \mathcal{F}[\gamma]
\end{array}$$

(4) Appealing to the universal property of  $1_{\text{Cat}}$ , we have that the functor

$$1_{\text{Cat}} \xrightarrow{p \circ i_1^{1_{\text{Cat}}, bi}} 1_{\text{Cat}}$$

is equal to

$$1_{\text{Cat}} \xrightarrow{id} 1_{\text{Cat}}.$$

(5) By definition, we have that the functor

$$\mathcal{I} \xrightarrow{r_1^{\mathcal{F}[\gamma]}} \mathcal{F}[\gamma]$$

corresponds to the arrow  $\gamma$  of  $\mathcal{F}[\gamma]$ .

(6) We deduce from (3) – (5) that the following diagram in  $\mathbf{Cat}$  commutes.

$$\begin{array}{ccc} 1_{\mathbf{Cat}} & \xrightarrow{0} & \mathcal{I} \\ & \searrow r_0^{\mathcal{F}[\gamma]} & \downarrow \gamma \\ & & \mathcal{F}[\gamma] \end{array}$$

(7) We deduce from (6) that the following diagram in  $\mathbf{Cat}$  commutes.

$$\begin{array}{ccc} 1_{\mathbf{Cat}} & \xrightarrow{0} & \mathcal{I} \\ & \searrow r_0^{\mathcal{F}[\gamma]} & \downarrow \text{can}_{\mathbf{F}_{2\text{-ring}}[\gamma]} \circ \gamma \\ \text{can}_{\mathbf{F}_{2\text{-ring}}[\gamma]} \circ r_0^{\mathcal{F}[\gamma]} & & \mathbf{F}_{2\text{-ring}}[\gamma] \end{array}$$

(8) By definition of the functor

$$\mathbf{F}_{2\text{-ring}}(1_{\mathbf{Cat}}) \xrightarrow{g} \mathbf{F}_{2\text{-ring}}[\gamma],$$

the following diagram in  $\mathbf{Cat}$  commutes.

$$\begin{array}{ccc} 1_{\mathbf{Cat}} & \xrightarrow{r_0^{\mathcal{F}[\gamma]}} & \mathcal{I} \\ \text{can}_{1_{\mathbf{Cat}}} \downarrow & & \downarrow \text{can}_{\mathbf{F}_{2\text{-ring}}[\gamma]} \\ \mathbf{F}_{2\text{-ring}}(1_{\mathbf{Cat}}) & \xrightarrow{g} & \mathbf{F}_{2\text{-ring}}[\gamma] \end{array}$$

(9) We deduce from (7) and (8) that the following diagram in  $\mathbf{Cat}$  commutes.

$$\begin{array}{ccc} 1_{\mathbf{Cat}} & \xrightarrow{0} & \mathcal{I} \\ & \searrow g \circ \text{can}_{1_{\mathbf{Cat}}} & \downarrow \text{can}_{\mathbf{F}_{2\text{-ring}}[\gamma]} \circ \gamma \\ & & \mathbf{F}_{2\text{-ring}}[\gamma] \end{array}$$

(10) We deduce from (9) that the following diagram in  $\mathbf{Cat}$  commutes.



$$\begin{array}{ccc}
1_{\text{Cat}} & \xrightarrow{0} & \mathcal{I} \\
& \searrow & \downarrow r_0^{\text{R}[\gamma]} \circ \text{can}_{\text{F}_2\text{-ring}[\gamma]} \circ \gamma \\
& & \text{R}[\gamma]
\end{array}$$

$r_0^{\text{R}[\gamma]} \circ g \circ \text{can}_{1_{\text{Cat}}}$

(11) By definition of the arrow  $\gamma$  of  $\text{F}_2\text{-ring}[\gamma]$ , we deduce from (10) that the following diagram in  $\text{Cat}$  commutes.

$$\begin{array}{ccc}
1_{\text{Cat}} & \xrightarrow{0} & \mathcal{I} \\
& \searrow & \downarrow \gamma \\
& & \text{R}[\gamma]
\end{array}$$

$r_0^{\text{R}[\gamma]} \circ g \circ \text{can}_{1_{\text{Cat}}}$

(12) By definition of  $\text{R}[\gamma]$ , the following diagram in  $\text{Cat}$  commutes.

$$\begin{array}{ccc}
\text{F}_2\text{-Ring}(1_{\text{Cat}}) & \xrightarrow{g} & \text{F}_2\text{-ring}[\gamma] \\
1_{\text{R}} \downarrow & & \downarrow r_0^{\text{R}[\gamma]} \\
\text{R} & \xrightarrow{r_1^{\text{R}[\gamma]}} & \text{R}[\gamma]
\end{array}$$

(13) We deduce from (11) and (12) that the following diagram in  $\text{Cat}$  commutes.

$$\begin{array}{ccc}
1_{\text{Cat}} & \xrightarrow{0} & \mathcal{I} \\
& \searrow & \downarrow \gamma \\
& & \text{R}[\gamma]
\end{array}$$

$r_1^{\text{R}[\gamma]} \circ 1_{\text{R}} \circ \text{can}_{1_{\text{Cat}}}$

(14) By definition of the functor

$$\text{F}_2\text{-ring}(1_{\text{Cat}}) \xrightarrow{1_{\text{R}}} \text{R},$$

the following diagram in  $\text{Cat}$  commutes.

$$\begin{array}{ccc}
1_{\text{Cat}} & \xrightarrow{\text{can}_{1_{\text{Cat}}}} & \mathbf{F}_{2\text{-ring}}(1_{\text{Cat}}) \\
& \searrow 1_{\mathbf{R}} & \downarrow 1_{\mathbf{R}} \\
& & \mathbf{R}
\end{array}$$

(15) By definition of a functor of 2-rings, the following diagram in  $\text{Cat}$  commutes.

$$\begin{array}{ccc}
1_{\text{Cat}} & \xrightarrow{1_{\mathbf{R}}} & \mathbf{R} \\
& \searrow 1_{\mathbf{R}[\gamma]} & \downarrow r_1^{\mathbf{R}[\gamma]} \\
& & \mathbf{R}[\gamma]
\end{array}$$

,

(16) We deduce from (13) – (15) that the following diagram in  $\text{Cat}$  commutes, as required.

$$\begin{array}{ccc}
1_{\text{Cat}} & \xrightarrow{0} & \mathcal{I} \\
& \searrow 1_{\mathbf{R}[\gamma]} & \downarrow \gamma \\
& & \mathbf{R}[\gamma]
\end{array}$$

□

**Proposition 3.2.5.16.** *The following diagram in  $\text{Cat}$  commutes.*

$$\begin{array}{ccc}
1_{\text{Cat}} & \xrightarrow{1} & \mathcal{I} \\
& \searrow 1_{\mathbf{R}[\gamma]} & \downarrow \gamma \\
& & \mathbf{R}[\gamma]
\end{array}$$

*Proof.* Entirely analogous to the proof of Proposition 3.2.5.15. □

**Corollary 3.2.5.17.** *We have that  $(\mathbf{R}[\gamma], \gamma, r_1^{\mathbf{R}[\gamma]})$  defines a Markov trace datum with respect to  $\mathbf{R}$ .*

*Proof.* Follows immediately from Proposition 3.2.5.15 and Proposition 3.2.5.16. □

**Remark 3.2.5.18.** In fact,  $(\mathbb{R}[\gamma], \gamma, r_1^{\mathbb{R}[\gamma]})$  is universal amongst Markov trace data with respect to  $\mathbb{R}$ . We shall not, however, need this universal property, and shall omit its precise statement and a proof.

### 3.3. The Kauffman bracket invariant

Given a datum  $\mathbb{S}$  for smoothing of braids, we construct in a canonical way a strict monoidal functor  $\text{Smoothing}$  from  $\mathbf{Braids}$  to  $\text{TL}(\mathbb{S})$  which, on arrows, we think of as ‘smoothing’ a braid to a formal linear sum of diagrammatic tangles in the usual way. Given a Markov trace datum  $\mathbb{T}$ , we combine this functor with the Markov trace functor with respect to  $\mathbb{T}$  constructed in §3.2.3, to define a strict monoidal functor from  $\mathbf{Braids}$  to a 2-ring  $\mathbb{T}$  which is constructed from the data of  $\mathbb{T}$ .

On arrows, we think of this functor as taking the Kauffman bracket of a braid. We then demonstrate that this strict monoidal functor gives rise to a functor from  $\mathbf{Braids}/\mathbf{R}$ -moves to  $\mathbb{T}$ . On arrows, we think of the construction of this last functor as a demonstration that the Kauffman bracket is a braid invariant.

#### 3.3.1. Smoothing functor

**Notation 3.3.1.1.** Let  $\mathbb{S} = (R, A, B)$  be a datum for smoothing of braids. We shall also denote the category which is part of the data of  $R$  by  $R$ .

**Notation 3.3.1.2.** Let us denote the source and target of  $A$  by  $a_0$  and  $a_1$  respectively. Let us denote the source and target of  $B$  by  $b_0$  and  $b_1$  respectively.

**Notation 3.3.1.3.** Throughout this chapter, we shall view the objects and arrows of  $\text{TL}_{\leq 2}$  as objects and arrows of  $\text{TL}$  via the functor

$$\text{TL}_{\leq 2} \xrightarrow{\text{can}_{\text{TL}}} \text{TL}.$$

In addition, we shall view the objects and arrows of  $\text{TL}$  as objects and arrows of  $\text{TL}(\mathbb{S})^{\text{pre}}$  via the functor

$$\text{TL} \xrightarrow{\text{can}_{\text{TL}(\mathbb{S})^{\text{pre}}}} \text{TL}(\mathbb{S})^{\text{pre}}.$$

Finally, we shall view the objects and arrows of  $\text{TL}(\mathbb{S})^{\text{pre}}$  as objects and arrows of  $\text{TL}(\mathbb{S})$  via the functor

$$\text{TL}(\mathbb{S})^{\text{pre}} \xrightarrow{\text{can}_{\text{TL}(\mathbb{S})}} \text{TL}(\mathbb{S}).$$

Viewing the object  $1$  of  $\text{TL}_{\leq 2}$  as an object of  $\text{TL}$ ,  $\text{TL}(\mathbb{S})^{\text{pre}}$ , or  $\text{TL}(\mathbb{S})$  in this way, we shall denote, for any integer  $n \geq 1$ , the object

$$\underbrace{1 \otimes_{\text{TL}} \cdots \otimes_{\text{TL}} 1}_n$$

of  $\text{TL}$  by  $n$ , and the object

$$\underbrace{1 \otimes_{\text{TL}(\mathbb{S})} \cdots \otimes_{\text{TL}(\mathbb{S})} 1}_n$$

of  $\text{TL}(\mathbb{S})$  by  $n$ .

**Notation 3.3.1.4.** Let

$$\mathcal{I} \sqcup \mathcal{I} \xrightarrow{s_{arr}} \text{TL}(\mathbb{S})$$

denote the canonical functor such that the diagrams

$$(A \otimes_{\text{TL}(\mathbb{S})} id(2)) \oplus_{\text{TL}(\mathbb{S})} (B \otimes_{\text{TL}(\mathbb{S})} \text{CupAndCap})$$

$$\begin{array}{ccc} \mathcal{I} & \xrightarrow{i_1^{\mathcal{I}, bi}} & \mathcal{I} \sqcup \mathcal{I} \\ & \searrow & \downarrow s_{arr} \\ & & \text{TL}(\mathbb{S}) \end{array}$$

and

$$(A \otimes_{\text{TL}(\mathbb{S})} \text{CupAndCap}) \oplus_{\text{TL}(\mathbb{S})} (B \otimes_{\text{TL}(\mathbb{S})} id(2))$$

$$\begin{array}{ccc} \mathcal{I} & \xrightarrow{i_2^{\mathcal{I}, bi}} & \mathcal{I} \sqcup \mathcal{I} \\ & \searrow & \downarrow s_{arr} \\ & & \text{TL}(\mathbb{S}) \end{array}$$

in  $\text{Cat}$  commute.

**Notation 3.3.1.5.** Let

$$1_{\text{Cat}} \sqcup 1_{\text{Cat}} \xrightarrow{s_{ob}} \text{TL}(\mathbb{S})$$

denote the canonical functor such that the following diagram in  $\text{Cat}$  commutes.

$$\begin{array}{ccccc} 1_{\text{Cat}} & \xrightarrow{1} & 1_{\text{Cat}} \sqcup 1_{\text{Cat}} & \xleftarrow{2} & 1_{\text{Cat}} \\ & \searrow 2 & \downarrow s_{ob} & \swarrow 2 & \\ & & \text{TL}(\mathbb{S}) & & \end{array}$$

**Proposition 3.3.1.6.** *The following diagram in  $\text{Cat}$  commutes.*

$$\begin{array}{ccc} 1_{\text{Cat}} & \xrightarrow{0} & \mathcal{I} \\ & \searrow 2 & \downarrow i_1^{\mathcal{I}, bi} \\ & & \mathcal{I} \sqcup \mathcal{I} \\ & & \downarrow s_{arr} \\ & & \text{TL}(\mathbb{S}) \end{array}$$

*Proof.* We make the following observations.

(1) By definition of  $s_{arr}$ , we have that the following diagram in  $\text{Cat}$  commutes.

$$\begin{array}{ccc}
 \mathcal{I} & \xrightarrow{i_1^{\mathcal{I},bi}} & \mathcal{I} \sqcup \mathcal{I} \\
 & \searrow & \downarrow s_{arr} \\
 (A \otimes_{\text{TL}(\mathbb{S})} id(2)) \oplus_{\text{TL}(\mathbb{S})} (B \otimes_{\text{TL}(\mathbb{S})} \text{CupAndCap}) & & \text{TL}(\mathbb{S})
 \end{array}$$

(2) By definition of  $A$ ,  $B$ ,  $id(2)$ , and  $\text{CupAndCap}$ , we have that the following diagram in  $\text{Cat}$ , in which the unlabelled arrow is

$$(A \otimes_{\text{TL}(\mathbb{S})} id(2)) \oplus_{\text{TL}(\mathbb{S})} (B \otimes_{\text{TL}(\mathbb{S})} \text{CupAndCap}),$$

commutes.

$$\begin{array}{ccc}
 1_{\text{Cat}} & \xrightarrow{0} & \mathcal{I} \\
 & \searrow & \downarrow \\
 (a_0 \otimes_{\text{TL}(\mathbb{S})} 2) \oplus_{\text{TL}(\mathbb{S})} (b_0 \otimes_{\text{TL}(\mathbb{S})} 2) & & \text{TL}(\mathbb{S})
 \end{array}$$

(3) By definition of  $\text{TL}(\mathbb{S})$ , the object

$$(a_0 \otimes_{\text{TL}(\mathbb{S})} 2) \oplus_{\text{TL}(\mathbb{S})} (b_0 \otimes_{\text{TL}(\mathbb{S})} 2)$$

of  $\text{TL}(\mathbb{S})$  is equal to the object  $2$  of  $\text{TL}(\mathbb{S})$ .

(4) We conclude from (1) – (3) that the following diagram in  $\text{Cat}$  commutes, as required.

$$\begin{array}{ccc}
 1_{\text{Cat}} & \xrightarrow{0} & \mathcal{I} \\
 & \searrow & \downarrow i_1^{\mathcal{I},bi} \\
 & & \mathcal{I} \sqcup \mathcal{I} \\
 & \searrow 2 & \downarrow s_{arr} \\
 & & \text{TL}(\mathbb{S})
 \end{array}$$

□

**Proposition 3.3.1.7.** *The following diagram in  $\mathbf{Cat}$  commutes.*

$$\begin{array}{ccc}
 1_{\mathbf{Cat}} & \xrightarrow{1} & \mathcal{I} \\
 & \searrow 2 & \downarrow i_1^{\mathcal{I},bi} \\
 & & \mathcal{I} \sqcup \mathcal{I} \\
 & & \downarrow s_{arr} \\
 & & \mathbf{TL}(\mathbb{S})
 \end{array}$$

*Proof.* Entirely analogous to the proof of Proposition 3.3.1.6. □

**Proposition 3.3.1.8.** *The following diagram in  $\mathbf{Cat}$  commutes.*

$$\begin{array}{ccc}
 1_{\mathbf{Cat}} & \xrightarrow{0} & \mathcal{I} \\
 & \searrow 2 & \downarrow i_2^{\mathcal{I},bi} \\
 & & \mathcal{I} \sqcup \mathcal{I} \\
 & & \downarrow s_{arr} \\
 & & \mathbf{TL}(\mathbb{S})
 \end{array}$$

*Proof.* Entirely analogous to the proof of Proposition 3.3.1.6. □

**Proposition 3.3.1.9.** *The following diagram in  $\mathbf{Cat}$  commutes.*

$$\begin{array}{ccc}
 1_{\mathbf{Cat}} & \xrightarrow{1} & \mathcal{I} \\
 & \searrow 2 & \downarrow i_2^{\mathcal{I},bi} \\
 & & \mathcal{I} \sqcup \mathcal{I} \\
 & & \downarrow s_{arr} \\
 & & \mathbf{TL}(\mathbb{S})
 \end{array}$$

*Proof.* Entirely analogous to the proof of Proposition 3.3.1.6. □

**Proposition 3.3.1.10.** *The following diagram in  $\mathbf{Cat}$  commutes.*

$$\begin{array}{ccc}
\partial\mathcal{I} \sqcup \partial\mathcal{I} & \xrightarrow{(2,2) \sqcup (2,2)} & 1_{\text{Cat}} \sqcup 1_{\text{Cat}} \\
(0,1) \sqcup (0,1) \downarrow & & \downarrow s_{ob} \\
\mathcal{I} \sqcup \mathcal{I} & \xrightarrow{s_{arr}} & \text{TL}(\mathbb{S})
\end{array}$$

*Proof.* We make the following observations.

(1) By definition of the functor

$$\partial\mathcal{I} \sqcup \partial\mathcal{I} \xrightarrow{(2,2) \sqcup (2,2)} 1_{\text{Cat}} \sqcup 1_{\text{Cat}},$$

the following diagram in  $\text{Cat}$ , in which this functor is the unlabelled middle arrow, commutes.

$$\begin{array}{ccccc}
\partial\mathcal{I} & \xrightarrow{i_1^{\partial\mathcal{I},bi}} & \partial\mathcal{I} \sqcup \partial\mathcal{I} & \xleftarrow{i_2^{\partial\mathcal{I},bi}} & \partial\mathcal{I} \\
& \searrow (2,2) & \downarrow & \swarrow (2,2) & \\
& & 1_{\text{Cat}} \sqcup 1_{\text{Cat}} & & 
\end{array}$$

(2) We deduce from (1) that the following diagram in  $\text{Cat}$ , in which the unlabelled middle arrow is  $s_{ob} \circ (2,2)$ , commutes.

$$\begin{array}{ccccc}
\partial\mathcal{I} & \xrightarrow{i_1^{\partial\mathcal{I},bi}} & \partial\mathcal{I} \sqcup \partial\mathcal{I} & \xleftarrow{i_2^{\partial\mathcal{I},bi}} & \partial\mathcal{I} \\
& \searrow s_{ob} \circ (2,2) & \downarrow & \swarrow s_{ob} \circ (2,2) & \\
& & 1_{\text{Cat}} \sqcup 1_{\text{Cat}} & & 
\end{array}$$

(3) We deduce from (2) and the definition of  $s_{ob}$  that the following diagram in  $\text{Cat}$  commutes.

$$\begin{array}{ccccc}
\partial\mathcal{I} & \xrightarrow{i_1^{\partial\mathcal{I},bi}} & \partial\mathcal{I} \sqcup \partial\mathcal{I} & \xleftarrow{i_2^{\partial\mathcal{I},bi}} & \partial\mathcal{I} \\
& \searrow (2,2) & \downarrow & \swarrow (2,2) & \\
& & 1_{\text{Cat}} \sqcup 1_{\text{Cat}} & & 
\end{array}$$



(4) By definition of the functor

$$\partial\mathcal{I} \sqcup \partial\mathcal{I} \xrightarrow{(0,1) \sqcup (0,1)} \mathcal{I} \sqcup \mathcal{I},$$

the following diagram in  $\mathbf{Cat}$ , in which this functor is the unlabelled middle arrow, commutes.

$$\begin{array}{ccccc} \partial\mathcal{I} & \xrightarrow{i_1^{\partial\mathcal{I},bi}} & \partial\mathcal{I} \sqcup \partial\mathcal{I} & \xleftarrow{i_2^{\partial\mathcal{I},bi}} & \partial\mathcal{I} \\ & \searrow i_1^{\mathcal{I},bi} \circ (0,1) & \downarrow & \swarrow i_2^{\mathcal{I},bi} \circ (0,1) & \\ & & \mathcal{I} \sqcup \mathcal{I} & & \end{array}$$

(5) We deduce from (4) that the following diagram in  $\mathbf{Cat}$ , in which the unlabelled middle arrow is  $s_{arr} \circ ((0,1) \sqcup (0,1))$ , commutes.

$$\begin{array}{ccccc} \partial\mathcal{I} & \xrightarrow{i_1^{\partial\mathcal{I},bi}} & \partial\mathcal{I} \sqcup \partial\mathcal{I} & \xleftarrow{i_2^{\partial\mathcal{I},bi}} & \partial\mathcal{I} \\ & \searrow s_{arr} \circ i_1^{\mathcal{I},bi} \circ (0,1) & \downarrow & \swarrow s_{arr} \circ i_2^{\mathcal{I},bi} \circ (0,1) & \\ & & \mathcal{I} \sqcup \mathcal{I} & & \end{array}$$

(6) We deduce from Proposition 3.3.1.6 and Proposition 3.3.1.6 that the following diagram in  $\mathbf{Cat}$  commutes.

$$\begin{array}{ccc} \partial\mathcal{I} & \xrightarrow{(0,1)} & \mathcal{I} \sqcup \mathcal{I} \\ & \searrow (2,2) & \downarrow s_{arr} \circ i_1^{\mathcal{I},bi} \\ & & \mathbf{TL}(\mathbb{S}) \end{array}$$

(7) We deduce from Proposition 3.3.1.6 and Proposition 3.3.1.6 that the following diagram in  $\mathbf{Cat}$  commutes.

$$\begin{array}{ccc} \partial\mathcal{I} & \xrightarrow{(0,1)} & \mathcal{I} \sqcup \mathcal{I} \\ & \searrow (2,2) & \downarrow s_{arr} \circ i_2^{\mathcal{I},bi} \\ & & \mathbf{TL}(\mathbb{S}) \end{array}$$

(8) We deduce from (5) – (7) that the following diagram in  $\text{Cat}$ , in which the unlabelled middle arrow is  $s_{arr} \circ ((0, 1) \sqcup (0, 1))$ , commutes.

$$\begin{array}{ccccc}
 \partial\mathcal{I} & \xrightarrow{i_1^{\cdot\partial\mathcal{I},bi}} & \partial\mathcal{I} \sqcup \partial\mathcal{I} & \xleftarrow{i_2^{\cdot\partial\mathcal{I},bi}} & \partial\mathcal{I} \\
 & \searrow (2,2) & \downarrow & \swarrow (2,2) & \\
 & & \mathcal{I} \sqcup \mathcal{I} & & 
 \end{array}$$

(9) We deduce from (2) and (8) that the following diagram in  $\text{Cat}$  commutes, as required.

$$\begin{array}{ccc}
 \partial\mathcal{I} \sqcup \partial\mathcal{I} & \xrightarrow{(2,2) \sqcup (2,2)} & 1_{\text{Cat}} \sqcup 1_{\text{Cat}} \\
 (0,1) \sqcup (0,1) \downarrow & & \downarrow s_{ob} \\
 \mathcal{I} \sqcup \mathcal{I} & \xrightarrow{s_{arr}} & \text{TL}(\mathbb{S})
 \end{array}$$

□

**Notation 3.3.1.11.** Appealing to Proposition 3.3.1.10, let us denote by

$$\text{Braids}_{\leq 2} \xrightarrow{\text{Smoothing}} \text{TL}(\mathbb{S})$$

the canonical functor such that the following diagram in  $\text{Cat}$  commutes.

$$\begin{array}{ccc}
 \partial\mathcal{I} \sqcup \partial\mathcal{I} & \xrightarrow{(2,2) \sqcup (2,2)} & 1_{\text{Cat}} \sqcup 1_{\text{Cat}} \\
 (0,1) \sqcup (0,1) \downarrow & & \downarrow r_0^{\text{Braids}_{\leq 2}} \\
 \mathcal{I} \sqcup \mathcal{I} & \xrightarrow{r_1^{\text{Braids}_{\leq 2}}} & \text{Braids}_{\leq 2} \\
 & & \downarrow \text{Smoothing} \\
 & & \text{TL}(\mathbb{S})
 \end{array}$$

$s_{arr}$  (curved arrow from  $\mathcal{I} \sqcup \mathcal{I}$  to  $\text{TL}(\mathbb{S})$ )  
 $s_{ob}$  (curved arrow from  $1_{\text{Cat}} \sqcup 1_{\text{Cat}}$  to  $\text{TL}(\mathbb{S})$ )

**Proposition 3.3.1.12.** *The following diagram in  $\mathbf{Cat}$  commutes.*

$$\begin{array}{ccc}
 1_{\mathbf{Cat}} & \xrightarrow{(1, 1)} & \mathbf{Braids}_{\leq 2} \times \mathbf{Braids}_{\leq 2} \\
 \downarrow 2 & & \downarrow \text{Smoothing} \times \text{Smoothing} \\
 & & \mathbf{TL}(\mathbb{S}) \times \mathbf{TL}(\mathbb{S}) \\
 & & \downarrow \otimes_{\mathbf{TL}(\mathbb{S})} \\
 \mathbf{Braids}_{\leq 2} & \xrightarrow{\text{Smoothing}} & \mathbf{TL}(\mathbb{S})
 \end{array}$$

*Proof.* We make the following observations.

(1) By definition of  $\text{Smoothing} \times \text{Smoothing}$ , the following diagram in  $\mathbf{Cat}$  commutes.

$$\begin{array}{ccc}
 \mathbf{Braids}_{\leq 2} \times \mathbf{Braids}_{\leq 2} & \xrightarrow{\text{Smoothing} \times \text{Smoothing}} & \mathbf{TL}(\mathbb{S}) \times \mathbf{TL}(\mathbb{S}) \\
 \downarrow p_1^{\mathbf{Braids}_{\leq 2}, bi} & & \downarrow p_1^{\mathbf{TL}(\mathbb{S}), bi} \\
 \mathbf{Braids}_{\leq 2} & \xrightarrow{\text{Smoothing}} & \mathbf{TL}(\mathbb{S})
 \end{array}$$

(2) By definition of the functor  $(1, 1)$ , the following diagram in  $\mathbf{Cat}$  commutes.

$$\begin{array}{ccc}
 1_{\mathbf{Cat}} & \xrightarrow{(1, 1)} & \mathbf{Braids}_{\leq 2} \times \mathbf{Braids}_{\leq 2} \\
 & \searrow 1 & \downarrow p_1^{\mathbf{Braids}_{\leq 2}, bi} \\
 & & \mathbf{Braids}_{\leq 2}
 \end{array}$$

(3) By definition of the functor  $1$ , the following diagram in  $\mathbf{Cat}$  commutes.

$$\begin{array}{ccc}
 1_{\mathbf{Cat}} & & \\
 \downarrow i_1^{\mathbf{1}_{\mathbf{Cat}}, bi} & \searrow 1 & \\
 1_{\mathbf{Cat}} \sqcup 1_{\mathbf{Cat}} & \xrightarrow{r_0^{\mathbf{Braids}_{\leq 2}}} & \mathbf{Braids}_{\leq 2}
 \end{array}$$

(4) We deduce from (2) and (3) that the following diagram in  $\mathbf{Cat}$  commutes.

$$\begin{array}{ccc}
 1_{\mathbf{Cat}} & \xrightarrow{(1, 1)} & \mathbf{Braids}_{\leq 2} \times \mathbf{Braids}_{\leq 2} \\
 \downarrow i_1^{1_{\mathbf{Cat}}} & & \downarrow p_1^{\mathbf{Braids}_{\leq 2}, bi} \\
 1_{\mathbf{Cat}} \sqcup 1_{\mathbf{Cat}} & \xrightarrow{r_0^{\mathbf{Braids}_{\leq 2}}} & \mathbf{Braids}_{\leq 2}
 \end{array}$$

(5) We deduce from (1) and (4) that the following diagram in  $\mathbf{Cat}$  commutes.

$$\begin{array}{ccc}
 1_{\mathbf{Cat}} & \xrightarrow{(\mathbf{Smoothing} \times \mathbf{Smoothing}) \circ (1, 1)} & \mathbf{TL}(\mathbb{S}) \times \mathbf{TL}(\mathbb{S}) \\
 \downarrow i_1^{1_{\mathbf{Cat}}, bi} & & \downarrow p_1^{\mathbf{TL}(\mathbb{S}), bi} \\
 1_{\mathbf{Cat}} \sqcup 1_{\mathbf{Cat}} & \xrightarrow{\mathbf{Smoothing} \circ r_0^{\mathbf{Braids}_{\leq 2}}} & \mathbf{TL}(\mathbb{S})
 \end{array}$$

(6) By definition of  $\mathbf{Smoothing}$ , we have that the following diagram in  $\mathbf{Cat}$  commutes.

$$\begin{array}{ccc}
 1_{\mathbf{Cat}} \sqcup 1_{\mathbf{Cat}} & \xrightarrow{r_0^{\mathbf{Braids}_{\leq 2}}} & \mathbf{Braids}_{\leq 2} \\
 & \searrow s_{ob} & \downarrow \mathbf{Smoothing} \\
 & & \mathbf{TL}(\mathbb{S})
 \end{array}$$

(7) We deduce from (5) and (6) that the following diagram in  $\mathbf{Cat}$  commutes.

$$\begin{array}{ccc}
 1_{\mathbf{Cat}} & \xrightarrow{(\mathbf{Smoothing} \times \mathbf{Smoothing}) \circ (1, 1)} & \mathbf{TL}(\mathbb{S}) \times \mathbf{TL}(\mathbb{S}) \\
 \downarrow i_1^{1_{\mathbf{Cat}}, bi} & & \downarrow p_1^{\mathbf{TL}(\mathbb{S}), bi} \\
 1_{\mathbf{Cat}} \sqcup 1_{\mathbf{Cat}} & \xrightarrow{s_{ob}} & \mathbf{TL}(\mathbb{S})
 \end{array}$$

(8) By definition of the functor

$$1_{\mathbf{Cat}} \sqcup 1_{\mathbf{Cat}} \xrightarrow{s_{ob}} \mathbf{TL}(\mathbb{S}),$$

we have that the following diagram in  $\mathbf{Cat}$  commutes.

$$\begin{array}{ccc}
1_{\text{Cat}} & \xrightarrow{i_1^{1_{\text{Cat}}, bi}} & 1_{\text{Cat}} \sqcup 1_{\text{Cat}} \\
& \searrow 1 & \downarrow s_{ob} \\
& & \text{TL}(\mathbb{S})
\end{array}$$

(9) We deduce from (7) and (8) that the following diagram in  $\text{Cat}$  commutes.

$$\begin{array}{ccc}
1_{\text{Cat}} & \xrightarrow{(\text{Smoothing} \times \text{Smoothing}) \circ (1, 1)} & \text{TL}(\mathbb{S}) \times \text{TL}(\mathbb{S}) \\
& \searrow 1 & \downarrow p_1^{\text{TL}(\mathbb{S}), bi} \\
& & \text{TL}(\mathbb{S})
\end{array}$$

(10) By an entirely analogous argument to that of (1) – (9), we have that the following diagram in  $\text{Cat}$  commutes.

$$\begin{array}{ccc}
1_{\text{Cat}} & \xrightarrow{(\text{Smoothing} \times \text{Smoothing}) \circ (1, 1)} & \text{TL}(\mathbb{S}) \times \text{TL}(\mathbb{S}) \\
& \searrow 1 & \downarrow p_2^{\text{TL}(\mathbb{S}), bi} \\
& & \text{TL}(\mathbb{S})
\end{array}$$

(11) We deduce from (9), (10), and the universal property of  $\text{TL}(\mathbb{S}) \times \text{TL}(\mathbb{S})$  that the following diagram in  $\text{Cat}$  commutes.

$$\begin{array}{ccc}
1_{\text{Cat}} & \xrightarrow{(1, 1)} & \text{Braids}_{\leq 2} \times \text{Braids}_{\leq 2} \\
& \searrow (1, 1) & \downarrow \text{Smoothing} \times \text{Smoothing} \\
& & \text{TL}(\mathbb{S}) \times \text{TL}(\mathbb{S})
\end{array}$$

(12) Appealing first to the universal property of  $\text{TL} \times \text{TL}$  and then to the universal property of  $\text{TL}(\mathbb{S}) \times \text{TL}(\mathbb{S})$ , it is an immediate consequence of the definition of the functor

$$1_{\text{Cat}} \xrightarrow{(1, 1)} \text{TL}(\mathbb{S}) \times \text{TL}(\mathbb{S})$$

that the following diagram in  $\mathbf{Cat}$  commutes.

$$\begin{array}{ccc}
 1_{\mathbf{Cat}} & \xrightarrow{(1,1)} & \mathbf{TL}_{\leq 2} \times \mathbf{TL}_{\leq 2} \\
 & \searrow & \downarrow \text{can}_{\mathbf{TL}} \times \text{can}_{\mathbf{TL}} \\
 & & \mathbf{TL} \times \mathbf{TL} \\
 & \searrow (1,1) & \downarrow \text{can}_{\mathbf{TL}(\mathbb{S})} \times \text{can}_{\mathbf{TL}(\mathbb{S})} \\
 & & \mathbf{TL}(\mathbb{S}) \times \mathbf{TL}(\mathbb{S})
 \end{array}$$

(13) Appealing to the universal property of  $\mathbf{TL}$ , we have that the following diagram in  $\mathbf{Cat}$  commutes.

$$\begin{array}{ccc}
 1_{\mathbf{Cat}} & \xrightarrow{(1,1)} & \mathbf{TL}_{\leq 2} \times \mathbf{TL}_{\leq 2} \\
 \downarrow 2 & & \downarrow \text{can}_{\mathbf{TL}} \times \text{can}_{\mathbf{TL}} \\
 & & \mathbf{TL} \times \mathbf{TL} \\
 & & \downarrow \otimes_{\mathbf{TL}} \\
 \mathbf{TL}_{\leq 2} & \xrightarrow{\text{can}_{\mathbf{TL}}} & \mathbf{TL}
 \end{array}$$

(14) Since  $\text{can}_{\mathbf{TL}(\mathbb{S})}$  is a functor of 2-rings, the following diagram in  $\mathbf{Cat}$  commutes.

$$\begin{array}{ccc}
 \mathbf{TL} \times \mathbf{TL} & \xrightarrow{\text{can}_{\mathbf{TL}(\mathbb{S})} \times \text{can}_{\mathbf{TL}(\mathbb{S})}} & \mathbf{TL}(\mathbb{S}) \times \mathbf{TL}(\mathbb{S}) \\
 \downarrow \otimes_{\mathbf{TL}} & & \downarrow \otimes_{\mathbf{TL}(\mathbb{S})} \\
 \mathbf{TL} & \xrightarrow{\text{can}_{\mathbf{TL}(\mathbb{S})}} & \mathbf{TL}(\mathbb{S})
 \end{array}$$

(15) By definition of the functor

$$1_{\mathbf{Cat}} \xrightarrow{2} \mathbf{TL}(\mathbb{S}),$$

we have that the following diagram in  $\mathbf{Cat}$  commutes.

$$\begin{array}{ccc}
1_{\text{Cat}} & & \\
\downarrow 2 & \searrow 2 & \\
\text{TL}_{\leq 2} & \xrightarrow{\text{can}_{\text{TL}(\mathbb{S})} \circ \text{can}_{\text{TL}}} & \text{TL}(\mathbb{S})
\end{array}$$

(16) We deduce from (11) – (15) that the following diagram in  $\text{Cat}$  commutes.

$$\begin{array}{ccc}
1_{\text{Cat}} & \xrightarrow{(1,1)} & \text{Braids}_{\leq 2} \times \text{Braids}_{\leq 2} \\
& \searrow 2 & \downarrow \text{Smoothing} \times \text{Smoothing} \\
& & \text{TL}(\mathbb{S}) \times \text{TL}(\mathbb{S}) \\
& & \downarrow \otimes_{\text{TL}} \\
& & \text{TL}(\mathbb{S})
\end{array}$$

(17) By definition of the functor

$$1_{\text{Cat}} \xrightarrow{2} \text{Braids}_{\leq 2},$$

the following diagram in  $\text{Cat}$  commutes.

$$\begin{array}{ccc}
1_{\text{Cat}} & & \\
\downarrow i_2^{1_{\text{Cat}}, bi} & \searrow 2 & \\
1_{\text{Cat}} \sqcup 1_{\text{Cat}} & \xrightarrow[r_0^{\text{Braids}_{\leq 2}}]{} & \text{Braids}_{\leq 2}
\end{array}$$

(18) We deduce from (17) that the following diagram in  $\text{Cat}$  commutes.

$$\begin{array}{ccc}
1_{\text{Cat}} & \xrightarrow{2} & \text{Braids}_{\leq 2} \\
\downarrow i_2^{1_{\text{Cat}}, bi} & & \downarrow \text{Smoothing} \\
1_{\text{Cat}} \sqcup 1_{\text{Cat}} & \xrightarrow[\text{Smoothing} \circ r_0^{\text{Braids}_{\leq 2}}]{} & \text{TL}(\mathbb{S})
\end{array}$$

(19) We deduce from (6) and (18) that the following diagram in  $\mathbf{Cat}$  commutes.

$$\begin{array}{ccc}
 1_{\mathbf{Cat}} & \xrightarrow{2} & \mathbf{Braids}_{\leq 2} \\
 \downarrow i_2^{1_{\mathbf{Cat}}, bi} & & \downarrow \text{Smoothing} \\
 1_{\mathbf{Cat}} \sqcup 1_{\mathbf{Cat}} & \xrightarrow{s_{ob}} & \mathbf{TL}(\mathbb{S})
 \end{array}$$

(20) By definition of the functor

$$1_{\mathbf{Cat}} \sqcup 1_{\mathbf{Cat}} \xrightarrow{s_{ob}} \mathbf{TL}(\mathbb{S}),$$

the following diagram in  $\mathbf{Cat}$  commutes.

$$\begin{array}{ccc}
 1_{\mathbf{Cat}} & \xrightarrow{i_2^{1_{\mathbf{Cat}}, bi}} & 1_{\mathbf{Cat}} \sqcup 1_{\mathbf{Cat}} \\
 \searrow 2 & & \downarrow s_{ob} \\
 & & \mathbf{TL}(\mathbb{S})
 \end{array}$$

(21) We deduce from (19) and (20) that the following diagram in  $\mathbf{Cat}$  commutes.

$$\begin{array}{ccc}
 1_{\mathbf{Cat}} & \xrightarrow{2} & \mathbf{Braids}_{\leq 2} \\
 \searrow 2 & & \downarrow \text{Smoothing} \\
 & & \mathbf{TL}(\mathbb{S})
 \end{array}$$

(22) We conclude from (16) and (21) that the following diagram in  $\mathbf{Cat}$  commutes, as required.

$$\begin{array}{ccc}
 1_{\mathbf{Cat}} & \xrightarrow{(1, 1)} & \mathbf{Braids}_{\leq 2} \times \mathbf{Braids}_{\leq 2} \\
 \downarrow 2 & & \downarrow \text{Smoothing} \times \text{Smoothing} \\
 & & \mathbf{TL}(\mathbb{S}) \times \mathbf{TL}(\mathbb{S}) \\
 & & \downarrow \otimes_{\mathbf{TL}(\mathbb{S})} \\
 \mathbf{Braids}_{\leq 2} & \xrightarrow{\text{Smoothing}} & \mathbf{TL}(\mathbb{S})
 \end{array}$$



□

**Corollary 3.3.1.13.** *The functor*

$$\text{Braids}_{\leq 2} \xrightarrow{\text{Smoothing}} \text{TL}(\mathbb{S})^{\text{mult}}$$

*exhibits  $\mathbb{M}_{\text{Braids}}$  as a monoidal datum for  $\text{TL}(\mathbb{S})^{\text{mult}}$ .*

*Proof.* Follows immediately from Proposition 3.3.1.12.

□

**Notation 3.3.1.14.** Appealing to Corollary 3.3.1.13, let

$$\text{Braids} \xrightarrow{\text{Smoothing}} \text{TL}(\mathbb{S})^{\text{mult}}$$

denote the canonical strict monoidal functor to which the functor

$$\text{Braids}_{\leq 2} \xrightarrow{\text{Smoothing}} \text{TL}(\mathbb{S})$$

gives rise, by means of the universal property of **Braids**.

**Remark 3.3.1.15.** The idea of the construction of **Smoothing** is as follows.

- (1) The objects 1 and 2 of  $\text{Braids}_{\leq 2}$  are sent to the objects of  $\text{TL}_{\leq 2}$  of the same denotation, viewed as objects of **TL** via the functor

$$\text{TL}_{\leq 2} \xrightarrow{\text{can}_{\text{TL}}} \text{TL}.$$

- (2) The arrow

$$2 \xrightarrow{\text{UnderCrossing}} 2$$

of  $\text{Braids}_{\leq 2}$

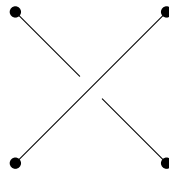

is sent to the arrow

$$2 \xrightarrow{(A \otimes_{\text{TL}(\mathbb{S})} \text{id}(2)) \oplus_{\text{TL}(\mathbb{S})} (B \otimes_{\text{TL}(\mathbb{S})} \text{CupAndCap})} 2$$

of  $\text{TL}(\mathbb{S})$ , namely a formal linear combination of the diagrammatic tangles  $id(2)$

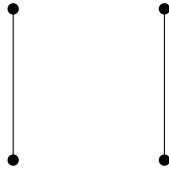

and CupAndCap.

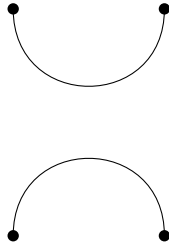

(3) The arrow

$$2 \xrightarrow{\text{OverCrossing}} 2$$

of  $\text{Braids}_{\leq 2}$

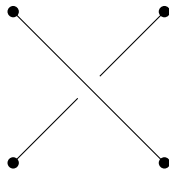

is sent to the arrow

$$2 \xrightarrow{(A \otimes_{\text{TL}(\mathbb{S})} \text{CupAndCap}) \oplus_{\text{TL}(\mathbb{S})} (B \otimes_{\text{TL}(\mathbb{S})} id(2))} 2$$

of  $\text{TL}(\mathbb{S})$ , namely the same formal linear combination of the diagrammatic tangles  $id(2)$

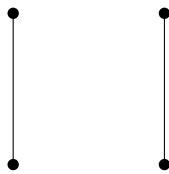

and CupAndCap

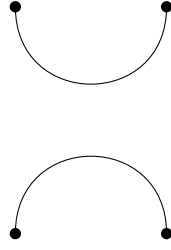

as in (2), but with the opposite choice of coefficients.

(4) We extend freely to all of  $\mathbf{Braids}_{\leq 2}$ . Thus, for instance, the arrow

$$2 \xrightarrow{\text{OverCrossing} \circ \text{UnderCrossing}} 2$$

of  $\mathbf{Braids}_{\leq 2}$

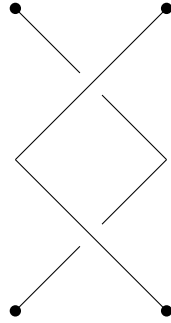

is sent, denoting  $\oplus_{\mathbf{TL}(\mathbb{S})}$  and  $\otimes_{\mathbf{TL}(\mathbb{S})}$  simply by  $\oplus$  and  $\otimes$  respectively, to the arrow

$$\begin{aligned} & \left( (A \otimes \text{CupAndCap}) \oplus (B \otimes \text{id}(2)) \right) \circ \left( (A \otimes \text{id}(2)) \oplus (B \otimes \text{CupAndCap}) \right) \\ &= \left( (A \otimes \text{CupAndCap}) \circ (A \otimes \text{id}(2)) \right) \oplus \left( (B \otimes \text{id}(2)) \circ (B \otimes \text{CupAndCap}) \right) \\ &= \left( (A \circ A) \otimes (\text{CupAndCap} \circ \text{id}(2)) \right) \oplus \left( (B \circ B) \otimes (\text{id}(2) \circ \text{CupAndCap}) \right) \\ &= ((A \circ A) \otimes \text{CupAndCap}) \oplus ((B \circ B) \otimes \text{CupAndCap}) \\ &= ((A \circ A) \oplus (B \circ B)) \otimes \text{CupAndCap} \end{aligned}$$

of  $\mathbf{TL}(\mathbb{S})$ . The first equality is a consequence of the functoriality of  $\oplus$ . The second is a consequence of the functoriality of  $\otimes$ . The fourth is a consequence of requirement (4) in the definition of a 2-ring, in Definition 2.1.3.2.

(5) We extend freely to all of Braids. Thus, for instance, the arrow

$$3 \xrightarrow{(id(1) \otimes_{\text{Braids}} \text{OverCrossing}) \circ (\text{UnderCrossing} \otimes_{\text{Braids}} id(1))} 3$$

of Braids

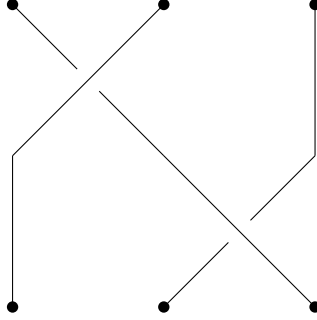

is sent, denoting  $\oplus_{\text{TL}(\mathbb{S})}$  and  $\otimes_{\text{TL}(\mathbb{S})}$  simply by  $\oplus$  and  $\otimes$  respectively, to the arrow

$$\begin{aligned} & \left( (A \otimes (id(1) \otimes_{\text{TL}} \text{CupAndCap})) \oplus (B \otimes id(3)) \right) \circ \left( (A \otimes id(3)) \oplus (B \otimes (\text{CupAndCap} \otimes_{\text{TL}} id(1))) \right) \\ &= \left( (A \otimes (id(1) \otimes_{\text{TL}} \text{CupAndCap})) \circ (A \otimes id(3)) \right) \oplus \left( (B \otimes id(3)) \circ (B \otimes (\text{CupAndCap} \otimes_{\text{TL}} id(1))) \right) \\ &= \left( (A \circ A) \otimes ((id(1) \otimes_{\text{TL}} \text{CupAndCap}) \circ id(3)) \right) \oplus \left( (B \circ B) \otimes (id(3) \circ (\text{CupAndCap} \otimes_{\text{TL}} id(1))) \right) \\ &= \left( (A \circ A) \otimes (id(1) \otimes_{\text{TL}} \text{CupAndCap}) \right) \oplus \left( (B \circ B) \otimes (\text{CupAndCap} \otimes_{\text{TL}} id(1)) \right) \end{aligned}$$

of  $\text{TL}(\mathbb{S})$ .

### 3.3.2. The Kauffman bracket

**Notation 3.3.2.1.** Let  $F_{\text{Mon}}(\mathcal{I})$  denote the free strict monoidal category on  $\mathcal{I}$ .

**Remark 3.3.2.2.** Let  $F_{2\text{-ring}}(\mathcal{I})$  denote the free 2-ring on  $\mathcal{I}$ . Appealing to Fact 2.2.3.4, we have that  $F_{2\text{-ring}}(\mathcal{I})$  can be viewed as the free 2-ring on  $F_{\text{Mon}}(\mathcal{I})$ .

**Notation 3.3.2.3.** Let

$$F_{2\text{-ring}}(\mathcal{I}) \xrightarrow{\text{Tr}^{\mathbb{S}} \circ \text{Smoothing} \circ \text{R2}_{\text{one}}(\text{one half})} \mathbb{T}$$

be the functor of 2-rings to which, by means of the universal property of  $F_{2\text{-ring}}(\mathcal{I})$  as the free 2-ring on  $F_{\text{Mon}}(\mathcal{I})$ , the strict monoidal functor

$$\mathcal{F}(\mathcal{I}) \xrightarrow{\text{Tr}^{\mathcal{S}} \circ \text{Smoothing} \circ \text{R2}_{\text{one}}(\text{one half})} \mathbb{T}^{\text{mult}}$$

gives rise.

**Notation 3.3.2.4.** Let

$$\mathbb{F}_{2\text{-ring}}(\mathcal{I}) \xrightarrow{\text{R2}_{\text{one}}(\text{other half})} \mathbb{T}$$

be the functor of 2-rings to which, by means of the universal property of  $\mathbb{F}_{2\text{-ring}}(\mathcal{I})$  as the free 2-ring on  $\mathbb{F}_{\text{Mon}}(\mathcal{I})$ , the strict monoidal functor

$$\mathcal{F}(\mathcal{I}) \xrightarrow{\text{Tr}^{\mathcal{S}} \circ \text{Smoothing} \circ \text{R2}_{\text{one}}(\text{other half})} \mathbb{T}^{\text{mult}}$$

gives rise.

**Notation 3.3.2.5.** Appealing to Fact 2.1.3.16, let

$$\mathbb{F}_{2\text{-ring}}(\mathcal{I}) \begin{array}{c} \xrightarrow{\text{Tr}^{\mathcal{S}} \circ \text{Smoothing} \circ \text{R2}_{\text{one}}(\text{one half})} \\ \xrightarrow{\hspace{10em}} \\ \xrightarrow{\text{Tr}^{\mathcal{S}} \circ \text{Smoothing} \circ \text{R2}_{\text{one}}(\text{other half})} \end{array} \mathbb{T} \xrightarrow{q_{\text{inv}}} \mathbb{T}_{\text{inv}}$$

be a coequaliser diagram in  $\text{Ring}(\text{Cat})$ .

**Notation 3.3.2.6.** Let us denote by

$$\text{Braids} \xrightarrow{\text{K}} \mathbb{T}_{\text{inv}}^{\text{mult}}$$

the strict monoidal functor  $q_{\text{inv}} \circ \text{Tr}^{\mathcal{S}} \circ \text{Smoothing}$ .

**Terminology 3.3.2.7.** We refer to

$$\text{Braids} \xrightarrow{\text{K}} \mathbb{T}_{\text{inv}}^{\text{mult}}$$

as the *Kauffman bracket*.

**Proposition 3.3.2.8.** *The following diagram in  $\text{Mon}(\text{Cat})$  commutes.*

$$\begin{array}{ccc} \mathbb{F}_{\text{Mon}}(\mathcal{I}) & \xrightarrow{\text{R2}_{\text{one}}(\text{one half})} & \text{Braids} \\ \downarrow \text{R2}_{\text{one}}(\text{other half}) & & \downarrow \text{K} \\ \text{Braids} & \xrightarrow{\text{K}} & \mathbb{T}_{\text{inv}}^{\text{mult}} \end{array}$$

*Proof.* Follows immediately from the definition of  $T_{\text{inv}}$ , the definition of the functor of 2-rings

$$F_{2\text{-ring}}(\mathcal{I}) \xrightarrow{\text{Tr}^{\mathbb{S}} \circ \text{Smoothing} \circ R_{2\text{one}}(\text{one half})} \mathbb{T}$$

and the definition of the functor of 2-rings

$$F_{2\text{-ring}}(\mathcal{I}) \xrightarrow{R_{2\text{one}}(\text{other half})} \mathbb{T}.$$

□

**Notation 3.3.2.9.** Appealing to Proposition 3.3.2.8 and the universal property of  $\text{Braids}/R_{2\text{one}}$ , let us denote by

$$\text{Braids}/R_{2\text{one}} \xrightarrow{K/R_{2\text{one}}} T_{\text{inv}}^{\text{mult}}$$

the canonical strict monoidal functor such that the following diagram in  $\text{Mon}(\text{Cat})$  commutes.

$$\begin{array}{ccc} \text{Braids} & \xrightarrow{q_{R_{2\text{one}}}} & \text{Braids}/R_{2\text{one}} \\ & \searrow K & \downarrow K/R_{2\text{one}} \\ & & T_{\text{inv}}^{\text{mult}} \end{array}$$

**Proposition 3.3.2.10.** *The following diagram in  $\text{Mon}(\text{Cat})$  commutes.*

$$\begin{array}{ccc} F_{\text{Mon}}(\mathcal{I}) & \xrightarrow{q_{R_{2\text{one}}} \circ R_{2\text{two}}(\text{one half})} & \text{Braids}/R_{2\text{one}} \\ \downarrow q_{R_{2\text{one}}} \circ R_{2\text{two}}(\text{other half}) & & \downarrow K/R_{2\text{one}} \\ \text{Braids}/R_{2\text{one}} & \xrightarrow{K/R_{2\text{one}}} & T_{\text{inv}}^{\text{mult}} \end{array}$$

*Proof.* We make the following observations.

- (1) Appealing to the functoriality of  $\text{Smoothing}$  and the functoriality of  $\text{Tr}^{\mathbb{S}}$ , the following diagram in  $\text{Cat}$ , in which the unlabelled arrow is

$$\mathcal{I} \xrightarrow{\text{Tr}^{\mathbb{S}}(\text{Smoothing}(\text{OverCrossing})) \circ \text{Tr}^{\mathbb{S}}(\text{Smoothing}(\text{UnderCrossing}))} \mathbb{T},$$

commutes.

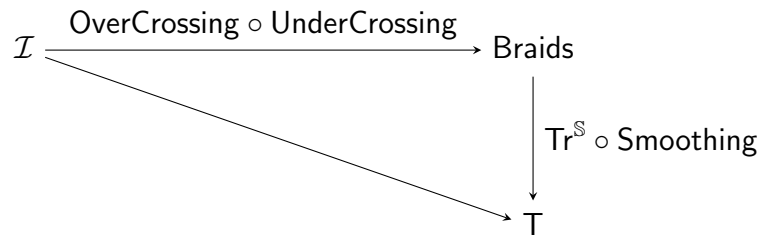

(2) By definition of **Smoothing**, the functor

$$\mathcal{I} \xrightarrow{\text{Tr}^{\mathbb{S}}(\text{Smoothing}(\text{UnderCrossing}))} \mathbb{T}$$

corresponds to an arrow

$$1_{\mathbb{T}} \longrightarrow 1_{\mathbb{T}}$$

of  $\mathbb{T}$ , and the functor

$$\mathcal{I} \xrightarrow{\text{Tr}^{\mathbb{S}}(\text{Smoothing}(\text{OverCrossing}))} \mathbb{T}$$

corresponds to an arrow

$$1_{\mathbb{T}} \longrightarrow 1_{\mathbb{T}}$$

of  $\mathbb{T}$ .

(3) We deduce from (1), (2), and Corollary ?? that the following diagram in **Cat**, in which the unlabelled arrow is

$$\mathcal{I} \xrightarrow{\text{Tr}^{\mathbb{S}}(\text{Smoothing}(\text{UnderCrossing})) \circ \text{Tr}^{\mathbb{S}}(\text{Smoothing}(\text{OverCrossing}))} \mathbb{T},$$

commutes.

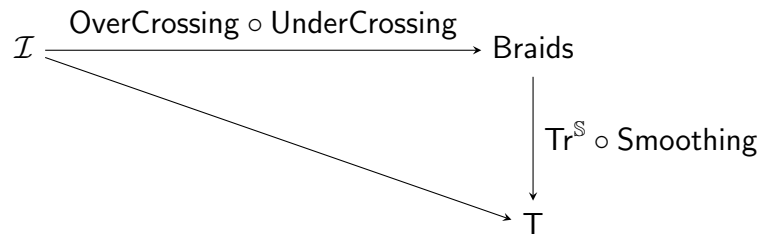

(4) Appealing to the functoriality of  $\text{Smoothing}$  and the functoriality of  $\text{Tr}^{\mathbb{S}}$ , the following diagram in  $\text{Cat}$ , in which the unlabelled arrow is

$$\mathcal{I} \xrightarrow{\text{Tr}^{\mathbb{S}}(\text{Smoothing}(\text{UnderCrossing})) \circ \text{Tr}^{\mathbb{S}}(\text{Smoothing}(\text{OverCrossing}))} \mathbb{T},$$

commutes.

$$\begin{array}{ccc} \mathcal{I} & & \\ \text{UnderCrossing} \circ \text{OverCrossing} \downarrow & \searrow & \\ \text{Braids} & \xrightarrow{\text{Tr}^{\mathbb{S}} \circ \text{Smoothing}} & \mathbb{T} \end{array}$$

(5) We deduce from (3) and (4) that the following diagram in  $\text{Cat}$  commutes.

$$\begin{array}{ccc} \mathcal{I} & \xrightarrow{\text{OverCrossing} \circ \text{UnderCrossing}} & \text{Braids} \\ \text{UnderCrossing} \circ \text{OverCrossing} \downarrow & & \downarrow \text{Tr}^{\mathbb{S}} \circ \text{Smoothing} \\ \text{Braids} & \xrightarrow{\text{Tr}^{\mathbb{S}} \circ \text{Smoothing}} & \mathbb{T} \end{array}$$

(6) By definition of the functors  $\text{R2}_{\text{one}}(\text{one half})$  and  $\text{R2}_{\text{two}}(\text{one half})$ , and appealing to the universal property of  $\text{F}_{\text{Mon}}(\mathcal{I})$ , we deduce from (5) that the following diagram in  $\text{Ring}(\text{Cat})$  commutes.

$$\begin{array}{ccc} \text{F}_{\text{Mon}}(\mathcal{I}) & \xrightarrow{\text{R2}_{\text{two}}(\text{one half})} & \text{Braids} \\ \text{R2}_{\text{one}}(\text{one half}) \downarrow & & \downarrow \text{Tr}^{\mathbb{S}} \circ \text{Smoothing} \\ \text{Braids} & \xrightarrow{\text{Tr}^{\mathbb{S}} \circ \text{Smoothing}} & \mathbb{T}^{\text{mult}} \end{array}$$

(7) By Proposition ??, the following diagram in  $\text{Mon}(\text{Cat})$  commutes.



$$\begin{array}{ccc}
F_{\text{Mon}}(\mathcal{I}) & \xrightarrow{R2_{\text{one}}(\text{one half})} & \text{Braids} \\
\downarrow R2_{\text{one}}(\text{other half}) & & \downarrow q_{\text{inv}} \circ \text{Tr}^{\mathbb{S}} \circ \text{Smoothing} \\
\text{Braids} & \xrightarrow{q_{\text{inv}} \circ \text{Tr}^{\mathbb{S}} \circ \text{Smoothing}} & T_{\text{inv}}^{\text{mult}}
\end{array}$$

(8) We deduce from (6), (7), and the definition of  $K$ , that the following diagram in  $\text{Mon}(\text{Cat})$  commutes.

$$\begin{array}{ccc}
F_{\text{Mon}}(\mathcal{I}) & \xrightarrow{R2_{\text{two}}(\text{one half})} & \text{Braids} \\
\downarrow R2_{\text{one}}(\text{other half}) & & \downarrow K \\
\text{Braids} & \xrightarrow{K} & T_{\text{inv}}^{\text{mult}}
\end{array}$$

(9) By definition, the strict monoidal functors  $R2_{\text{one}}(\text{other half})$  and  $R2_{\text{two}}(\text{other half})$  are equal.

(10) We deduce from (8) and (9) that the following diagram in  $\text{Mon}(\text{Cat})$  commutes.

$$\begin{array}{ccc}
F_{\text{Mon}}(\mathcal{I}) & \xrightarrow{R2_{\text{two}}(\text{one half})} & \text{Braids} \\
\downarrow R2_{\text{two}}(\text{other half}) & & \downarrow K \\
\text{Braids} & \xrightarrow{K} & T_{\text{inv}}^{\text{mult}}
\end{array}$$

(11) By definition of  $K/R2_{\text{one}}$ , the following diagram in  $\text{Mon}(\text{Cat})$  commutes.

$$\begin{array}{ccc}
\text{Braids} & \xrightarrow{q_{R2_{\text{one}}}} & \text{Braids}/R2_{\text{one}} \\
\searrow K & & \downarrow K/R2_{\text{one}} \\
& & T_{\text{inv}}
\end{array}$$

(12) We deduce from (10) and (11) that the following diagram in  $\text{Mon}(\text{Cat})$  commutes, as required.

$$\begin{array}{ccc}
F_{\text{Mon}}(\mathcal{I}) & \xrightarrow{q_{R2_{\text{one}}} \circ R2_{\text{two}}(\text{one half})} & \text{Braids}/R2_{\text{one}} \\
\downarrow q_{R2_{\text{one}}} \circ R2_{\text{two}}(\text{other half}) & & \downarrow K/R2_{\text{one}} \\
\text{Braids}/R2_{\text{one}} & \xrightarrow{K/R2_{\text{one}}} & T_{\text{inv}}^{\text{mult}}
\end{array}$$

□

**Notation 3.3.2.11.** Appealing to Proposition 3.3.2.10 and the universal property of  $\text{Braids}/R2_{\text{both}}$ , let us denote by

$$\text{Braids}/R2_{\text{both}} \xrightarrow{K/R2_{\text{both}}} T_{\text{inv}}^{\text{mult}}$$

the canonical strict monoidal functor such that the following diagram in  $\text{Mon}(\text{Cat})$  commutes.

$$\begin{array}{ccc}
\text{Braids}/R2_{\text{one}} & \xrightarrow{q_{R2_{\text{two}}}} & \text{Braids}/R2_{\text{both}} \\
\searrow K/R2_{\text{one}} & & \downarrow K/R2_{\text{both}} \\
& & T_{\text{inv}}^{\text{mult}}
\end{array}$$

**Proposition 3.3.2.12.** *The following diagram in  $\text{Mon}(\text{Cat})$  commutes.*

$$\begin{array}{ccc}
F_{\text{Mon}}(\mathcal{I}) & \xrightarrow{q_{R2_{\text{both}}} \circ R3_{\text{one}}(\text{one half})} & \text{Braids}/R2_{\text{both}} \\
\downarrow q_{R2_{\text{both}}} \circ R3_{\text{one}}(\text{other half}) & & \downarrow K/R2_{\text{both}} \\
\text{Braids}/R2_{\text{both}} & \xrightarrow{K/R2_{\text{one}}} & T_{\text{inv}}^{\text{mult}}
\end{array}$$

*Proof.* Similar to the proof of Proposition 3.3.2.10. The key point is that, by Proposition 2.1.3.20, and the fact  $\text{Tr}^{\text{S}}$  and **Smoothing** are strict monoidal functors, we have

$$K/R2_{\text{both}}(\text{OverCrossing} \otimes id(1)) = K/R2_{\text{both}}(id(1) \otimes \text{OverCrossing}).$$

□

**Notation 3.3.2.13.** Appealing to Proposition 3.3.2.12 and the universal property of  $\text{Braids}/R$ -moves, let us denote by

$$\text{Braids/R-moves} \xrightarrow{\text{K/R-moves}} \mathbb{T}_{\text{inv}}^{\text{mult}}$$

the canonical strict monoidal functor such that the following diagram in  $\text{Mon}(\text{Cat})$  commutes.

$$\begin{array}{ccc} \text{Braids/R2}_{\text{both}} & \xrightarrow{q_{\text{R-moves}}} & \text{Braids/R-moves} \\ & \searrow \text{K/R2}_{\text{both}} & \downarrow \text{K/R-moves} \\ & & \mathbb{T}_{\text{inv}}^{\text{mult}} \end{array}$$

**Terminology 3.3.2.14.** We refer to the functor

$$\text{Braids/R-moves} \xrightarrow{\text{K/R-moves}} \mathbb{T}_{\text{inv}}^{\text{mult}}$$

as the *Kauffman bracket invariant* of braids.

**Remark 3.3.2.15.** The idea of the construction of K/R-moves is as follows.

- (1) We define the Kauffman bracket of a braid, namely the strict monoidal functor

$$\text{Braids} \xrightarrow{\text{K}} \mathbb{T}^{\text{mult}},$$

to be the Markov trace of its smoothing to a diagrammatic tangle.

- (2) We modify  $\mathbb{T}$  to ensure that  $\text{K}$  is invariant under  $\text{R2}_{\text{one}}$ , by forcing the Kauffman bracket of two halves of  $\text{R2}_{\text{one}}$  to become equal. We denote the 2-ring that we obtain from  $\mathbb{T}$  in this way by  $\mathbb{T}_{\text{inv}}$ .
- (3) Making use of a cyclicity property of  $\text{Tr}^{\mathbb{S}}$ , we demonstrate that the Kauffman bracket to  $\mathbb{T}_{\text{inv}}$  is invariant under both  $\text{R2}_{\text{two}}$  and  $\text{R3}_{\text{one}}$ . Taking into consideration Remark 3.1.2.45, we thus have that the Kauffman bracket to  $\mathbb{T}_{\text{inv}}$  is invariant all the Reidemeister moves  $\text{R2}_{\text{one}}$ ,  $\text{R2}_{\text{two}}$ ,  $\text{R3}_{\text{one}}$ ,  $\text{R3}_{\text{two}}$ ,  $\dots$ ,  $\text{R3}_{\text{six}}$ . In other words, it is an invariant of braids.

**Remark 3.3.2.16.** We make the following observations.

$$\begin{aligned}
& \text{Tr}^{\mathbb{S}} \circ \text{Smoothing} \circ (\text{UnderCrossing} \circ \text{OverCrossing}) \\
&= \text{Tr}^{\mathbb{S}} \left( (A \otimes \text{id}(2)) \oplus (B \otimes \text{CupAndCap}) \right) \circ \text{Tr}^{\mathbb{S}} \left( (A \otimes \text{CupAndCap}) \oplus (B \otimes \text{id}(2)) \right) \\
&= \left( (A \otimes \text{id}(1_{\mathbb{T}})) \oplus (B \otimes \gamma) \right) \circ \left( (A \otimes \gamma) \oplus (B \otimes \text{id}(1_{\mathbb{T}})) \right) \\
&= \left( (A \otimes \text{id}(1_{\mathbb{T}})) \oplus (B \otimes \gamma) \right) \otimes \left( (A \otimes \gamma) \oplus (B \otimes \text{id}(1_{\mathbb{T}})) \right) \\
&= \left( A \oplus (B \otimes \gamma) \right) \otimes \left( (A \otimes \gamma) \oplus B \right) \\
&= \left( A \otimes ((A \otimes \gamma) \oplus B) \right) \oplus \left( (B \otimes \gamma) \otimes ((A \otimes \gamma) \oplus B) \right) \\
&= (A \otimes A \otimes \gamma) \oplus (A \otimes B) \oplus (B \otimes \gamma \otimes A \otimes \gamma) \oplus (B \otimes \gamma \otimes B) \\
&= (A \otimes A \otimes \gamma) \oplus (A \otimes B \otimes \gamma \otimes \gamma) \oplus (A \otimes B) \oplus (B \otimes B \otimes \gamma)
\end{aligned}$$

The first equality holds by the definition of **UnderCrossing** and **OverCrossing**, the functoriality of **Smoothing**, and the functoriality and definition of  $\text{Tr}^{\mathbb{S}}$ . The second equality holds by definition of  $\text{Tr}^{\mathbb{S}}$  and the fact that  $\text{Tr}^{\mathbb{S}}$  is a functor of 2-rings. The third equality holds by Corollary ???. The fourth equality holds by definition of  $1_{\mathbb{T}}$  as the unit for the multiplicative structure of  $\mathbb{T}$ . The fifth and sixth equalities hold because  $\mathbb{T}$  is a 2-ring. The final equality holds by Corollary ???.

Let

$$\text{F}_{2\text{-ring}}(\mathcal{I}) \xrightarrow{(A \otimes A \otimes \gamma) \oplus (A \otimes B \otimes \gamma \otimes \gamma) \oplus (A \otimes B) \oplus (B \otimes B \otimes \gamma)} \mathbb{T}$$

denote the functor of 2-rings to which the functor

$$\mathcal{I} \xrightarrow{(A \otimes A \otimes \gamma) \oplus (A \otimes B \otimes \gamma \otimes \gamma) \oplus (A \otimes B) \oplus (B \otimes B \otimes \gamma)} \mathbb{T}$$

gives rise. Let

$$\text{F}_{2\text{-ring}}(\mathcal{I}) \xrightarrow{1_{\mathbb{T}}} \mathbb{T}$$

denote the functor of 2-rings to which the functor

$$\mathcal{I} \xrightarrow{1_{\mathbb{T}}} \mathbb{T}$$

gives rise. Then, by the above calculation and the definition of  $\mathbb{T}_{\text{inv}}$ , the following diagram in  $\text{Ring}(\text{Cat})$  defines a coequaliser.

$$\begin{array}{ccc}
\text{F}_{2\text{-ring}}(\mathcal{I}) & \xrightarrow{(A \otimes A \otimes \gamma) \oplus (A \otimes B \otimes \gamma \otimes \gamma) \oplus (A \otimes B) \oplus (B \otimes B \otimes \gamma)} & \mathbb{T} \\
& \xrightarrow{id(1_{\mathbb{T}})} & \mathbb{T} \xrightarrow{q_{\text{inv}}} \mathbb{T}_{\text{inv}}
\end{array}$$

**Remark 3.3.2.17.** We make the following observations.

$$\begin{aligned}
& \text{Smoothing} \circ (\text{UnderCrossing} \circ \text{OverCrossing}) \\
&= \left( (A \otimes \text{id}(2)) \oplus (B \otimes \text{CupAndCap}) \right) \circ \left( (A \otimes \text{CupAndCap}) \oplus (B \otimes \text{id}(2)) \right) \\
&= \left( (A \otimes \text{id}(2)) \circ (A \otimes \text{CupAndCap}) \right) \oplus \left( (B \otimes \text{CupAndCap}) \circ (B \otimes \text{id}(2)) \right) \\
&= \left( (A \circ A) \otimes (\text{id}(2) \circ \text{CupAndCap}) \right) \oplus \left( (B \circ B) \otimes (\text{CupAndCap} \circ \text{id}(2)) \right) \\
&= ((A \circ A) \otimes \text{CupAndCap}) \oplus ((B \circ B) \otimes \text{CupAndCap}) \\
&= ((A \circ A) \oplus (B \circ B)) \otimes \text{CupAndCap}
\end{aligned}$$

The first equality holds by the definition of **UnderCrossing** and **OverCrossing**, and the functoriality of **Smoothing**. The second holds by the functoriality of  $\oplus$ . The third holds by the functoriality of  $\otimes$ . The fifth holds because  $\text{TL}(\mathbb{S})$  is a 2-ring.

By the functoriality and definition of  $\text{Tr}^{\mathbb{S}}$ , we deduce that

$$\text{Tr}^{\mathbb{S}} \circ \text{Smoothing} \circ (\text{UnderCrossing} \circ \text{OverCrossing})$$

is equal to

$$((A \circ A) \oplus (B \circ B)) \otimes \gamma,$$

and thus, appealing to Corollary ??, to

$$((A \otimes A) \oplus (B \otimes B)) \otimes \gamma.$$

Hence, and by definition of  $\mathbb{T}_{\text{inv}}$ , the following diagram in  $\text{Ring}(\text{Cat})$  defines a co-equaliser.

$$\begin{array}{ccc}
& ((A \otimes A) \oplus (B \otimes B)) \otimes \gamma & \\
\text{F}_{2\text{-ring}}(\mathcal{I}) & \xrightarrow{\quad\quad\quad} & \mathbb{T} \xrightarrow{q_{\text{inv}}} \mathbb{T}_{\text{inv}} \\
& \xrightarrow{\quad id(1_{\mathbb{T}}) \quad} &
\end{array}$$

**Remark 3.3.2.18.** Let  $\mathbb{R}$  and  $\mathbb{R}[A, B]$  be the 2-rings of Remark 3.2.2.20. Let  $\mathbb{S}$  be the smoothing datum of Remark 3.2.2.20. Let  $\mathbb{R}[\gamma]$  be the 2-ring of Remark 3.2.3.26. Let  $\mathbb{T}$  be the Markov trace datum of Remark 3.2.3.26. Let

$$\text{Braids/R-moves} \xrightarrow{\text{K/R-moves}} \mathbb{T}$$

be the Kauffman bracket invariant with respect to  $\mathbb{S}$  and  $\mathbb{T}$ . Then, on arrows,  $\mathbb{K}$  is then exactly the usual Kauffman bracket of a braid. Indeed, if we restrict  $\mathbb{K}$  to the group of endomorphisms of the object  $n$  of **Braids**, then it recovers exactly the morphism of groups

$$\mathcal{B}_n \longrightarrow \mathbb{N}[A, B, \gamma]$$

defining the usual Kauffman bracket, where  $\mathcal{B}_n$  is the braid group on  $n$  strands.

## 3.4. Examples

### 3.4.1. Hopf link

**Notation 3.4.1.1.** Throughout this section, we shall view the objects and arrows of  $\mathbf{Braids}_{\leq 2}$  as objects and arrows of  $\mathbf{Braids}$  via the functor

$$\mathbf{Braids}_{\leq 2} \xrightarrow{\text{can}_{\mathbf{Braids}}} \mathbf{Braids}.$$

Viewing the object 1 of  $\mathbf{Braids}_{\leq 2}$  as an object of  $\mathbf{Braids}$  in this way, we shall denote, for any integer  $n \geq 1$ , the object

$$\underbrace{1 \otimes_{\mathbf{Braids}} \cdots \otimes_{\mathbf{Braids}} 1}_n$$

of  $\mathbf{Braids}$  by  $n$ .

Given a datum for smoothing of braids  $\mathbb{S} = (\mathbf{R}, A, B)$ , we shall similarly view the objects and arrows of  $\mathbf{TL}_{\leq 2}$  as objects and arrows of  $\mathbf{TL}$  via the functor

$$\mathbf{TL}_{\leq 2} \xrightarrow{\text{can}_{\mathbf{TL}}} \mathbf{TL}.$$

In addition, we shall view the objects and arrows of  $\mathbf{TL}$  as objects and arrows of  $\mathbf{TL}(\mathbb{S})^{\text{pre}}$  via the functor

$$\mathbf{TL} \xrightarrow{\text{can}_{\mathbf{TL}(\mathbb{S})^{\text{pre}}}} \mathbf{TL}(\mathbb{S})^{\text{pre}}.$$

Finally, we shall view the objects and arrows of  $\mathbf{TL}(\mathbb{S})^{\text{pre}}$  as objects and arrows of  $\mathbf{TL}(\mathbb{S})$  via the functor

$$\mathbf{TL}(\mathbb{S})^{\text{pre}} \xrightarrow{\text{can}_{\mathbf{TL}(\mathbb{S})}} \mathbf{TL}(\mathbb{S}).$$

Viewing the object 1 of  $\mathbf{TL}_{\leq 2}$  as an object of  $\mathbf{TL}$ ,  $\mathbf{TL}(\mathbb{S})^{\text{pre}}$ , or  $\mathbf{TL}(\mathbb{S})$  in this way, we shall denote, for any integer  $n \geq 1$ , the object

$$\underbrace{1 \otimes_{\mathbf{TL}} \cdots \otimes_{\mathbf{TL}} 1}_n$$

of  $\mathbf{TL}$  by  $n$ , and the object

$$\underbrace{1 \otimes_{\mathbf{TL}(\mathbb{S})} \cdots \otimes_{\mathbf{TL}(\mathbb{S})} 1}_n$$

of  $\mathbf{TL}(\mathbb{S})$  by  $n$ .

**Notation 3.4.1.2.** In the following examples, we are denoting  $\oplus_{\mathbf{TL}(\mathbb{S})}$  and  $\otimes_{\mathbf{TL}(\mathbb{S})}$  simply by  $\oplus$  and  $\otimes$  respectively.

**Notation 3.4.1.3.** Let us denote the arrow

$$2 \xrightarrow{\text{OverCrossing}} 2$$

of Braids

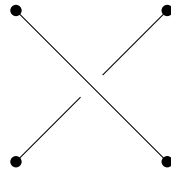

by  $\sigma$ .

**Notation 3.4.1.4.** Let us denote the arrow

$$2 \xrightarrow{\text{UnderCrossing}} 2$$

of Braids

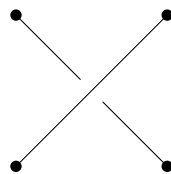

by  $\sigma^{-1}$ .

**Notation 3.4.1.5.** Let us denote the arrow

$$2 \xrightarrow{\text{CupAndCap}} 2$$

of  $\text{TL}(\mathbb{S})$

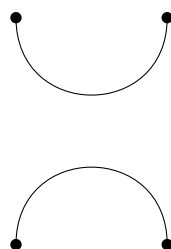

by  $\tau$ .

**Notation 3.4.1.6.** We denote the arrow

$$2 \xrightarrow{\sigma \circ \sigma} 2$$

of Braids

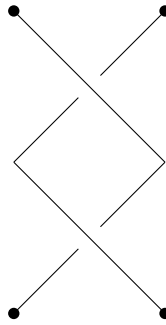

by Hopf.

**Example 3.4.1.7.** Let  $\mathbb{S} = (R, A, B)$  be a datum for smoothing of braids. Let  $\mathbb{T} = (\mathbb{T}^{\text{pre}}, \gamma, t)$  be a Markov trace datum with respect to  $R$ . We make the following observations.

(1) By functoriality, the arrow

$$2 \xrightarrow{\text{Smoothing}(\text{Hopf})} 2$$

of  $\text{TL}(\mathbb{S})$  is equal to

$$2 \xrightarrow{\text{Smoothing}(\sigma) \circ \text{Smoothing}(\sigma)} 2.$$

(2) By definition of **Smoothing**, the arrow

$$2 \xrightarrow{\text{Smoothing}(\sigma)} 2$$

is equal to

$$2 \xrightarrow{(A \otimes \text{CupAndCap}) \oplus (B \otimes \text{id}(2))} 2.$$



(3) We have that

$$\begin{aligned}
& \left( (A \otimes \text{CupAndCap}) \oplus (B \otimes id(2)) \right) \circ \left( (A \otimes \text{CupAndCap}) \oplus (B \otimes id(2)) \right) \\
&= \left( (A \otimes \text{CupAndCap}) \circ (A \otimes \text{CupAndCap}) \right) \oplus \left( (B \otimes id(2)) \circ (B \otimes id(2)) \right) \\
&= \left( (A \circ A) \otimes (\text{CupAndCap} \circ \text{CupAndCap}) \right) \oplus \left( (B \circ B) \otimes (id(2) \circ id(2)) \right) \\
&= \left( (A \circ A) \otimes (\text{CupAndCap} \circ \text{CupAndCap}) \right) \oplus \left( (B \circ B) \otimes id(2) \right)
\end{aligned}$$

of  $\text{TL}(\mathbb{S})$ .

(4) We deduce from (1) – (3) that the arrow

$$2 \xrightarrow{\text{Smoothing}(\text{Hopf})} 2$$

of  $\text{TL}$  is equal to

$$2 \xrightarrow{\left( (A \circ A) \otimes (\text{CupAndCap} \circ \text{CupAndCap}) \right) \oplus \left( (B \circ B) \otimes id(2) \right)} 2.$$

(5) The Markov trace of  $\text{Smoothing}(\text{Hopf})$  is, denoting  $t(A)$ ,  $t(B)$ ,  $\otimes_{\text{Tr}^{\text{pre}}}$  and  $\oplus_{\text{Tr}^{\text{pre}}}$  simply by  $A$ ,  $B$ ,  $\otimes$  and  $\oplus$  respectively,

$$\begin{aligned}
& \text{Tr}^{\mathbb{S}} \circ \text{Smoothing}(\text{Hopf}) \\
&= \text{Tr}^{\mathbb{S}} \left( \left( (A \circ A) \otimes (\text{CupAndCap} \circ \text{CupAndCap}) \right) \oplus \left( (B \circ B) \otimes id(2) \right) \right) \\
&= \left( (A \circ A) \otimes (\gamma \circ \gamma) \right) \oplus (B \circ B) \\
&= \left( (A \otimes A) \otimes (\gamma \otimes \gamma) \right) \oplus (B \otimes B)
\end{aligned}$$

Or, simply

$$\text{Tr}^{\mathbb{S}} \circ \text{Smoothing}(\text{Hopf}) = A^2 \gamma^2 \oplus B^2.$$

**Notation 3.4.1.8.** We denote the arrow

$$2 \xrightarrow{\sigma \circ \sigma \circ \sigma} 2$$

of Braids

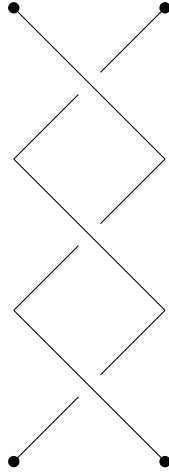

by Trefoil.

**Example 3.4.1.9.** Let  $\mathbb{S} = (\mathbb{R}, A, B)$  be a datum for smoothing of braids. Let  $\mathbb{T} = (\mathbb{T}^{\text{pre}}, \gamma, t)$  be a Markov trace datum with respect to  $\mathbb{R}$ . We make the following observations.

(1) By functoriality, the arrow

$$2 \xrightarrow{\text{Smoothing}(\text{Trefoil})} 2$$

of  $\text{TL}(\mathbb{S})$  is equal to

$$2 \xrightarrow{\text{Smoothing}(\sigma) \circ \text{Smoothing}(\sigma) \circ \text{Smoothing}(\sigma)} 2.$$

(2) By definition of **Smoothing**, the arrow

$$2 \xrightarrow{\text{Smoothing}(\sigma)} 2$$

is equal to

$$2 \xrightarrow{(A \otimes \text{CupAndCap}) \oplus (B \otimes \text{id}(2))} 2.$$

(3) From Example 3.4.1.7 we have that

$$2 \xrightarrow{\text{Smoothing}(\sigma) \circ \text{Smoothing}(\sigma)} 2$$

of TL is equal to

$$2 \xrightarrow{((A \circ A) \otimes (\text{CupAndCap} \circ \text{CupAndCap})) \oplus ((B \circ B) \otimes \text{id}(2))} 2.$$

(4) We have that

$$\begin{aligned} & \left( (A \otimes \text{CupAndCap}) \oplus (B \otimes \text{id}(2)) \right) \\ & \circ \left( ((A \circ A) \otimes (\text{CupAndCap} \circ \text{CupAndCap})) \oplus ((B \circ B) \otimes \text{id}(2)) \right) \\ &= \left( (A \otimes \text{CupAndCap}) \circ ((A \circ A) \otimes (\text{CupAndCap} \circ \text{CupAndCap})) \right) \\ &= \oplus \left( (B \otimes \text{id}(2)) \circ ((B \circ B) \otimes \text{id}(2)) \right) \\ &= \left( (A \circ (A \circ A)) \otimes (\text{CupAndCap} \circ (\text{CupAndCap} \circ \text{CupAndCap})) \right) \\ &= \oplus \left( (B \circ (B \circ B)) \otimes (\text{id}(2) \circ \text{id}(2)) \right) \\ &= \left( (A \circ A \circ A) \otimes (\text{CupAndCap} \circ \text{CupAndCap} \circ \text{CupAndCap}) \right) \oplus \left( (B \circ B \circ B) \otimes \text{id}(2) \right) \end{aligned}$$

of TL(S).

(5) We deduce from (1) – (4) that the arrow

$$2 \xrightarrow{\text{Smoothing(Trefoil)}} 2$$

of TL is equal to

$$2 \xrightarrow{((A \circ A \circ A) \otimes (\text{CupAndCap} \circ \text{CupAndCap} \circ \text{CupAndCap})) \oplus ((B \circ B \circ B) \otimes \text{id}(2))} 2.$$

(6) The Markov trace of Smooting(Trefoil) is, denoting  $t(A)$ ,  $t(B)$ ,  $\otimes_{\text{Tpre}}$  and  $\oplus_{\text{Tpre}}$  simply by  $A$ ,  $B$ ,  $\otimes$  and  $\oplus$  respectively,

$$\begin{aligned} & \text{Tr}^{\mathbb{S}} \circ \text{Smooting(Trefoil)} \\ &= \text{Tr}^{\mathbb{S}} \left( ((A \circ A \circ A) \otimes (\text{CupAndCap} \circ \text{CupAndCap} \circ \text{CupAndCap})) \oplus ((B \circ B \circ B) \otimes \text{id}(2)) \right) \\ &= ((A \circ A \circ A) \otimes (\gamma \circ \gamma \circ \gamma)) \oplus (B \circ B \circ B) \\ &= ((A \otimes A \otimes A) \otimes (\gamma \otimes \gamma \otimes \gamma)) \oplus (B \otimes B \otimes B) \end{aligned}$$



(2) By definition of **Smoothing**, the arrow

$$3 \xrightarrow{\text{Smoothing}(\sigma^{-1} \otimes_{\text{Braids}} id(1))} 3$$

is equal to

$$3 \xrightarrow{(A \otimes id(3)) \oplus (B \otimes (\text{CupAndCap} \otimes_{\text{TL}} id(1)))} 3.$$

(3) By definition of **Smoothing**, the arrow

$$3 \xrightarrow{\text{Smoothing}(id(1) \otimes_{\text{Braids}} \sigma)} 3$$

is equal to

$$3 \xrightarrow{(A \otimes (id(1) \otimes_{\text{TL}} \text{CupAndCap})) \oplus (B \otimes id(3))} 3.$$

(4) We have that

$$\begin{aligned} & \left( (A \otimes id(3)) \oplus (B \otimes (\text{CupAndCap} \otimes_{\text{TL}} id(1))) \right) \circ \left( (A \otimes (id(1) \otimes_{\text{TL}} \text{CupAndCap})) \oplus (B \otimes id(3)) \right) \\ & \circ \left( (A \otimes id(3)) \oplus (B \otimes (\text{CupAndCap} \otimes_{\text{TL}} id(1))) \right) \circ \left( (A \otimes (id(1) \otimes_{\text{TL}} \text{CupAndCap})) \oplus (B \otimes id(3)) \right) \\ = & \left( (A \otimes id(3)) \circ (A \otimes (id(1) \otimes_{\text{TL}} \text{CupAndCap})) \circ (A \otimes id(3)) \circ (A \otimes (id(1) \otimes_{\text{TL}} \text{CupAndCap})) \right) \\ & \oplus \left( (B \otimes (\text{CupAndCap} \otimes_{\text{TL}} id(1))) \circ (B \otimes id(3)) \circ (B \otimes (\text{CupAndCap} \otimes_{\text{TL}} id(1))) \circ (B \otimes id(3)) \right) \\ = & \left( ((A \circ A \circ A \circ A) \otimes id(3) \circ (id(1) \otimes_{\text{TL}} \text{CupAndCap}) \circ id(3) \circ (id(1) \otimes_{\text{TL}} \text{CupAndCap})) \right) \\ & \oplus \left( ((B \circ B \circ B \circ B) \otimes (\text{CupAndCap} \otimes_{\text{TL}} id(1)) \circ id(3) \circ (\text{CupAndCap} \otimes_{\text{TL}} id(1)) \circ id(3)) \right) \\ = & \left( (A \circ A \circ A \circ A) \otimes (id(1) \otimes_{\text{TL}} (\text{CupAndCap} \circ \text{CupAndCap})) \right) \\ & \oplus \left( (B \circ B \circ B \circ B) \otimes ((\text{CupAndCap} \circ \text{CupAndCap}) \otimes_{\text{TL}} id(1)) \right) \end{aligned}$$

of  $\text{TL}(\mathbb{S})$ .

(5) We deduce from (1) – (4) that the arrow

$$3 \xrightarrow{\text{Smoothing(FigureEight)}} 3$$

of TL is equal to

$$3 \xrightarrow{\left( (A \circ A \circ A \circ A) \otimes (id(1) \otimes_{\text{TL}} (\text{CupAndCap} \circ \text{CupAndCap})) \right) \oplus \left( (B \circ B \circ B \circ B) \otimes ((\text{CupAndCap} \circ \text{CupAndCap}) \otimes_{\text{TL}} id(1)) \right)} 3.$$

(6) The Markov trace of Smooting(FigureEight) is, denoting  $t(A)$ ,  $t(B)$ ,  $\otimes_{\text{TL}}$  and  $\oplus_{\text{TL}}$  simply by  $A$ ,  $B$ ,  $\otimes$  and  $\oplus$  respectively,

$$\begin{aligned} & \text{Tr}^{\mathcal{S}} \circ \text{Smooting(FigureEight)} \\ &= \text{Tr}^{\mathcal{S}} \left( \left( (A \circ A \circ A \circ A) \otimes (id(1) \otimes_{\text{TL}} (\text{CupAndCap} \circ \text{CupAndCap})) \right) \oplus \left( (B \circ B \circ B \circ B) \otimes ((\text{CupAndCap} \circ \text{CupAndCap}) \otimes_{\text{TL}} id(1)) \right) \right) \\ &= ((A \circ A \circ A \circ A) \otimes (\gamma \circ \gamma)) \oplus ((B \circ B \circ B \circ B) \otimes (\gamma \circ \gamma)) \\ &= ((A \otimes A \otimes A \otimes A) \otimes (\gamma \otimes \gamma)) \oplus ((B \otimes B \otimes B \otimes B) \otimes (\gamma \otimes \gamma)) \end{aligned}$$

Or, simply

$$\text{Tr}^{\mathcal{S}} \circ \text{Smooting(FigureEight)} = A^4 \gamma^2 \oplus B^4 \gamma^2.$$

**Notation 3.4.1.12.** We denote the arrow

$$3 \xrightarrow{(\sigma \otimes_{\text{Braids}} id(1)) \circ (id(1) \otimes_{\text{Braids}} \sigma^{-1}) \circ (id(1) \otimes_{\text{Braids}} \sigma^{-1}) \circ (\sigma \otimes_{\text{Braids}} id(1))} 3$$

of Braids

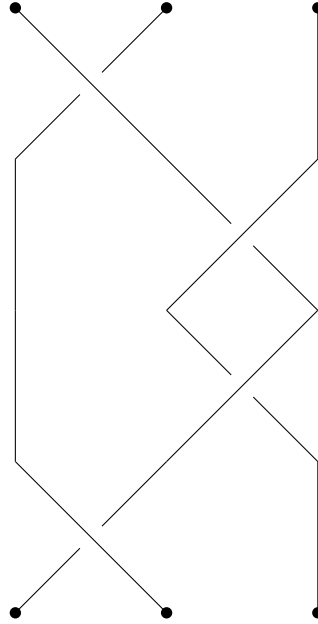

by Twohopf.

**Example 3.4.1.13.** Let  $\mathbb{S} = (\mathbb{R}, A, B)$  be a datum for smoothing of braids. Let  $\mathbb{T} = (\mathbb{T}^{\text{pre}}, \gamma, t)$  be a Markov trace datum with respect to  $\mathbb{R}$ . We make the following observations.

(1) By functoriality, the arrow

$$3 \xrightarrow{\text{Smoothing}(\text{Twohopf})} 3$$

of  $\text{TL}(\mathbb{S})$  is equal to

$$3 \xrightarrow{\text{Smoothing}(\sigma \otimes_{\text{Braids}} id(1)) \circ \text{Smoothing}(id(1) \otimes_{\text{Braids}} \sigma^{-1}) \circ \text{Smoothing}(id(1) \otimes_{\text{Braids}} \sigma^{-1}) \circ \text{Smoothing}(\sigma \otimes_{\text{Braids}} id(1))} 3.$$

(2) By definition of **Smoothing**, the arrow

$$3 \xrightarrow{\text{Smoothing}(\sigma \otimes_{\text{Braids}} id(1))} 3$$

is equal to

$$3 \xrightarrow{(A \otimes (\text{CupAndCap} \otimes_{\text{TL}} id(1))) \oplus (B \otimes id(3))} 3.$$

(3) By definition of **Smoothing**, the arrow

$$3 \xrightarrow{\text{Smoothing}(id(1) \otimes_{\text{Braids}} \sigma^{-1})} 3$$

is equal to

$$3 \xrightarrow{(A \otimes id(3)) \oplus (B \otimes (id(1) \otimes_{\text{TL}} \text{CupAndCap}))} 3.$$

(4) We have that

$$\begin{aligned} & \left( (A \otimes (\text{CupAndCap} \otimes_{\text{TL}} id(1))) \oplus (B \otimes id(3)) \right) \circ \left( (A \otimes id(3)) \oplus (B \otimes (id(1) \otimes_{\text{TL}} \text{CupAndCap})) \right) \\ & \circ \left( (A \otimes id(3)) \oplus (B \otimes (id(1) \otimes_{\text{TL}} \text{CupAndCap})) \right) \circ \left( (A \otimes (\text{CupAndCap} \otimes_{\text{TL}} id(1))) \oplus (B \otimes id(3)) \right) \\ = & \left( (A \otimes (\text{CupAndCap} \otimes_{\text{TL}} id(1))) \circ (A \otimes id(3)) \circ (A \otimes id(3)) \circ (A \otimes (\text{CupAndCap} \otimes_{\text{TL}} id(1))) \right) \\ & \oplus \left( (B \otimes id(3)) \circ (B \otimes (id(1) \otimes_{\text{TL}} \text{CupAndCap})) \circ (B \otimes (id(1) \otimes_{\text{TL}} \text{CupAndCap})) \circ (B \otimes id(3)) \right) \\ = & \left( (A \circ A \circ A \circ A) \otimes ((\text{CupAndCap} \otimes_{\text{TL}} id(1)) \circ id(3) \circ id(3) \circ (\text{CupAndCap} \otimes_{\text{TL}} id(1))) \right) \\ & \oplus \left( (B \circ B \circ B \circ B) \otimes (id(3) \circ ((id(1) \otimes_{\text{TL}} \text{CupAndCap}) \circ (id(1) \otimes_{\text{TL}} \text{CupAndCap}) \circ id(3)) \right) \\ = & \left( (A \circ A \circ A \circ A) \otimes ((\text{CupAndCap} \circ \text{CupAndCap}) \otimes_{\text{TL}} id(1)) \right) \\ & \oplus \left( (B \circ B \circ B \circ B) \otimes ((id(1) \otimes_{\text{TL}} (\text{CupAndCap} \circ \text{CupAndCap})) \right) \end{aligned}$$

of  $\text{TL}(\mathbb{S})$ .

(5) We deduce from (1) – (4) that the arrow

$$3 \xrightarrow{\text{Smoothing}(\text{Twohopf})} 3$$

of  $\text{TL}$  is equal to

$$3 \xrightarrow{\left( (A \circ A \circ A \circ A) \otimes ((\text{CupAndCap} \circ \text{CupAndCap}) \otimes_{\text{TL}} id(1)) \right) \oplus \left( (B \circ B \circ B \circ B) \otimes ((id(1) \otimes_{\text{TL}} (\text{CupAndCap} \circ \text{CupAndCap})) \right)} 3.$$



(6) The Markov trace of **Smoothing(Twohopf)** is, denoting  $t(A)$ ,  $t(B)$ ,  $\otimes_{\mathbb{T}^{\text{pre}}}$  and  $\oplus_{\mathbb{T}^{\text{pre}}}$  simply by  $A$ ,  $B$ ,  $\otimes$  and  $\oplus$  respectively,

$$\begin{aligned} & \text{Tr}^{\mathbb{S}} \circ \text{Smoothing}(\text{Twohopf}) \\ &= \text{Tr}^{\mathbb{S}} \left( \left( (A \circ A \circ A \circ A) \otimes ((\text{CupAndCap} \circ \text{CupAndCap}) \otimes_{\text{TL}} \text{id}(1)) \right) \right) \\ & \quad \oplus \left( (B \circ B \circ B \circ B) \otimes (\text{id}(1) \otimes_{\text{TL}} (\text{CupAndCap} \circ \text{CupAndCap})) \right) \\ &= ((A \circ A \circ A \circ A) \otimes (\gamma \circ \gamma)) \oplus ((B \circ B \circ B \circ B) \otimes ((\gamma \circ \gamma))) \\ &= ((A \otimes A \otimes A \otimes A) \otimes (\gamma \otimes \gamma)) \oplus ((B \otimes B \otimes B \otimes B) \otimes ((\gamma \otimes \gamma))) \end{aligned}$$

Or, simply

$$\text{Tr}^{\mathbb{S}} \circ \text{Smoothing}(\text{Twohopf}) = A^4 \gamma^2 \oplus B^4 \gamma^2.$$

**Notation 3.4.1.14.** We denote the arrow

$$4 \xrightarrow{(\sigma \otimes_{\text{Braids}} \text{id}(2)) \circ (\sigma \otimes_{\text{Braids}} \text{id}(2)) \circ (\text{id}(2) \otimes_{\text{Braids}} \sigma) \circ (\text{id}(2) \otimes_{\text{Braids}} \sigma)} 4$$

of Braids

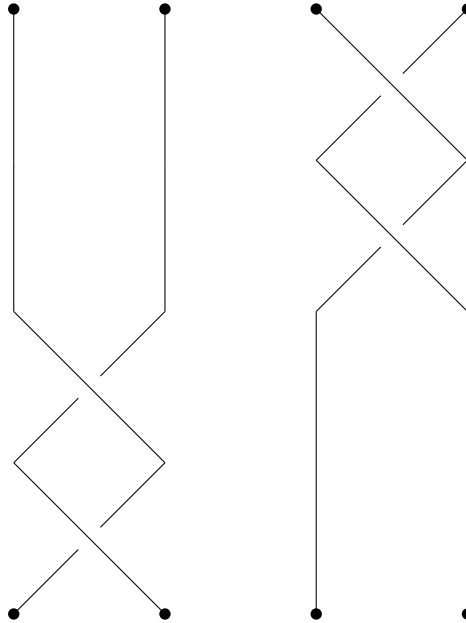

by  $\text{Hopf} \sqcup \text{Hopf}$ .

**Example 3.4.1.15.** Let  $\mathbb{S} = (\mathbb{R}, A, B)$  be a datum for smoothing of braids. Let  $\mathbb{T} = (\mathbb{T}^{\text{pre}}, \gamma, t)$  be a Markov trace datum with respect to  $\mathbb{R}$ . We make the following observations.

(1) By functoriality, the arrow

$$4 \xrightarrow{\text{Smoothing}(\text{Hopf} \sqcup \text{Hopf})} 4$$

of  $\text{TL}(\mathbb{S})$  is equal to

$$4 \xrightarrow{\begin{array}{c} \text{Smoothing}(\sigma \otimes_{\text{Braids}} id(2)) \circ \text{Smoothing}(\sigma \otimes_{\text{Braids}} id(2)) \\ \circ \text{Smoothing}(id(2) \otimes_{\text{Braids}} \sigma) \circ \text{Smoothing}(id(2) \otimes_{\text{Braids}} \sigma) \end{array}} 4.$$

(2) By definition of **Smoothing**, the arrow

$$4 \xrightarrow{\text{Smoothing}(\sigma \otimes_{\text{Braids}} id(2))} 4$$

is equal to

$$4 \xrightarrow{\left( A \otimes (\text{CupAndCap} \otimes_{\text{TL}} id(2)) \right) \oplus (B \otimes id(4))} 4.$$

(3) By definition of **Smoothing**, the arrow

$$4 \xrightarrow{\text{Smoothing}(id(2) \otimes_{\text{Braids}} \sigma)} 4$$

is equal to

$$4 \xrightarrow{\left( A \otimes (id(2) \otimes_{\text{TL}} \text{CupAndCap}) \right) \oplus (B \otimes id(4))} 4.$$

(4) We have that

$$\begin{aligned}
& \left( (A \otimes (\text{CupAndCap} \otimes_{\text{TL}} id(2))) \oplus (B \otimes id(4)) \right) \circ \left( (A \otimes (\text{CupAndCap} \otimes_{\text{TL}} id(2))) \oplus (B \otimes id(4)) \right) \\
& \circ \left( (A \otimes (id(2) \otimes_{\text{TL}} \text{CupAndCap})) \oplus (B \otimes id(4)) \right) \circ \left( (A \otimes (id(2) \otimes_{\text{TL}} \text{CupAndCap})) \oplus (B \otimes id(4)) \right) \\
& = \left( (A \otimes (\text{CupAndCap} \otimes_{\text{TL}} id(2))) \circ (A \otimes (\text{CupAndCap} \otimes_{\text{TL}} id(2))) \right. \\
& \quad \left. \circ (A \otimes (id(2) \otimes_{\text{TL}} \text{CupAndCap})) \circ (A \otimes (id(2) \otimes_{\text{TL}} \text{CupAndCap})) \right) \\
& \quad \oplus \left( (B \otimes id(4)) \circ (B \otimes id(4)) \circ (B \otimes id(4)) \circ (B \otimes id(4)) \right) \\
& = \left( (A \circ A \circ A \circ A) \otimes \left( (\text{CupAndCap} \otimes_{\text{TL}} id(2)) \circ (\text{CupAndCap} \otimes_{\text{TL}} id(2)) \right. \right. \\
& \quad \left. \left. \circ (id(2) \otimes_{\text{TL}} \text{CupAndCap}) \circ (id(2) \otimes_{\text{TL}} \text{CupAndCap}) \right) \right) \\
& \quad \oplus \left( (B \circ B \circ B \circ B) \otimes (id(4) \circ id(4) \circ id(4) \circ id(4)) \right) \\
& = \left( (A \circ A \circ A \circ A) \otimes \left( ((\text{CupAndCap} \circ \text{CupAndCap}) \otimes_{\text{TL}} id(2)) \right. \right. \\
& \quad \left. \left. \circ (id(2) \otimes_{\text{TL}} (\text{CupAndCap} \circ \text{CupAndCap})) \right) \right) \\
& \quad \oplus \left( (B \circ B \circ B \circ B) \otimes id(4) \right)
\end{aligned}$$

of  $\text{TL}(\mathbb{S})$ .

(5) We deduce from (1) – (4) that the arrow

$$4 \xrightarrow{\text{Smoothing}(\text{Hopf} \sqcup \text{Hopf})} 4$$

of  $\text{TL}$  is equal to

$$\begin{aligned}
& \left( (A \circ A \circ A \circ A) \otimes \left( ((\text{CupAndCap} \circ \text{CupAndCap}) \otimes_{\text{TL}} id(2)) \right. \right. \\
& \quad \left. \left. \circ (id(2) \otimes_{\text{TL}} (\text{CupAndCap} \circ \text{CupAndCap})) \right) \right) \\
& \quad \oplus \left( (B \circ B \circ B \circ B) \otimes id(4) \right) \\
& 4 \xrightarrow{\hspace{15em}} 4.
\end{aligned}$$

(6) The Markov trace of  $\text{Smoothing}(\text{Hopf} \sqcup \text{Hopf})$  is, denoting  $t(A)$ ,  $t(B)$ ,  $\otimes_{\text{TL}^{\text{pre}}}$  and

$\oplus_{\mathbb{T}^{\text{pre}}}$  simply by  $A$ ,  $B$ ,  $\otimes$  and  $\oplus$  respectively,

$$\begin{aligned}
& \text{Tr}^{\mathbb{S}} \circ \text{Smoothing}(\text{Hopf} \sqcup \text{Hopf}) \\
&= \text{Tr}^{\mathbb{S}} \left( \left( (A \circ A \circ A \circ A) \otimes \left( ((\text{CupAndCap} \circ \text{CupAndCap}) \otimes_{\text{TL}} \text{id}(2)) \right. \right. \right. \\
&\quad \left. \left. \left. \circ (\text{id}(2) \otimes_{\text{TL}} (\text{CupAndCap} \circ \text{CupAndCap})) \right) \right) \right) \\
&\quad \left. \oplus ((B \circ B \circ B \circ B) \otimes \text{id}(4)) \right) \\
&= ((A \circ A \circ A \circ A) \otimes (\gamma \circ \gamma \circ \gamma \circ \gamma)) \oplus ((B \circ B \circ B \circ B)) \\
&= ((A \otimes A \otimes A \otimes A) \otimes (\gamma \otimes \gamma \otimes \gamma \otimes \gamma)) \oplus ((B \otimes B \otimes B \otimes B))
\end{aligned}$$

Or, simply

$$\text{Tr}^{\mathbb{S}} \circ \text{Smoothing}(\text{Hopf} \sqcup \text{Hopf}) = A^4 \gamma^4 \oplus B^4.$$



---

---

## CHAPTER 4

---

A KAUFFMAN BRACKET INVARIANT  
FOR 2-BRAIDS IN A 2-CATEGORICAL  
FRAMEWORK

## 4.1. 2-categories of 2-braids

We define a cubical 2-category  $2\text{-Braids}$  in two steps. On objects and 1-arrows,  $2\text{-Braids}$  is identical to  $\text{Braids}$ . We think of the 2-arrows of  $2\text{-Braids}$  as *2-braids*, which for us are planes, possibly broken, joining four braids which we depict as drawn on two of the pairs of opposite faces of a cube.

The first step is to define a cubical 2-category  $2\text{-Braids}^{\text{double}}$  as the free strict monoidal cubical 2-category on a monoidal datum  $\mathbb{M}_{2\text{-Braids}^{\text{double}}}$ . The 2-arrows of  $2\text{-Braids}^{\text{double}}$  correspond to those 2-braids without triple plane crossings, namely with only double plane crossings.

To obtain  $2\text{-Braids}$  from  $2\text{-Braids}^{\text{double}}$ , we glue in 2-arrows which we think of as triple plane crossings. Formally, we express this glueing by means of a colimit  $\text{Mon}(2\text{-Cat})$ .

The analogues in diagrammatic 2-knot theory of the Reidemeister moves are known as *Roseman moves*. First investigated by Homma and Nagase in the papers [6] and [7], the fact that these moves detect isotopy of 2-knots was discussed by Roseman in [15].

We formulate those Roseman moves which are relevant for defining isotopy of 2-braids, namely the bubble, saddle, triple, and tetrahedral moves, in terms of 2-arrows of  $2\text{-Braids}$ . We define a strict monoidal cubical 2-category  $2\text{-Braids}/\text{R-moves}$  by taking a colimit in  $\text{Mon}(2\text{-Cat})$  which identifies the two sides of each of these moves.

On objects and 1-arrows,  $2\text{-Braids}/\text{R-moves}$  is identical to  $\text{Braids}/\text{R-moves}$ . We think of the arrows of  $2\text{-Braids}/\text{R-moves}$  as 2-braids up to isotopy. We view our work in this section as carrying out an algebraisation of the theory of 2-braids in a topological sense. This algebraisation involves identifying 2-braids which can be considered to generate all others, in the same sense as `OverCrossing` and `UnderCrossing` generate all braids. This is a subtler matter than for braids. The generators involving two planes are *not*, for instance, double crossings in the sense of 2-knot theory, but rather fragments (we often think of them as quarters) of these. Partly as a consequence of this, there are 2-arrows of  $2\text{-Braids}$  which are *not* invertible. In other words,  $2\text{-Braids}$  is *not* a cubical 2-groupoid.

Though the pictures which we draw of our 2-braid generators are only, for us, informal notation, we consider them as a vital an aspect of our work as the formal development. Indeed, we feel that the algebraisation we have arrived at marries what appears to be natural and fundamental from an algebraic point of view, and what appears to be natural and fundamental from a topological point of view.

We are not aware that any algebraisation of the topological theory of 2-braids has previously been suggested. Despite the importance to which we attach a natural topological interpretation of our 2-braids, we do not regard our algebraisation as standing or falling on whether *any* 2-braid in one's preferred topological sense can be captured in our framework, so long as the theory of 2-braids *defined* by  $2\text{-Braids}/\text{R-moves}$  is rich and interesting, as we feel it is.

In defining  $2\text{-Braids}/\text{R-moves}$ , we have not investigated in depth which of the Roseman moves become identities as a consequence of forcing some of the other Roseman moves to become identities, in the manner we discussed in §3.1. We consider this to be an interesting problem, which we plan to explore in future work.

In the light of Remark 3.1.2.45, it is natural to ask if **2-Braids** can be viewed as the free braided monoidal cubical 2-category on  $1_{2\text{-Cat}}$ . We feel this to be plausible, but have not yet looked into it.

### 4.1.1. The 2-category of 2-braids

**Notation 4.1.1.1.** Throughout this section, we view  $\mathbf{Braids}_{\leq 2}$  and  $\mathbf{Braids}$  as having been constructed as a cubical 2-category, by carrying out exactly the same construction as in §3.1.1, but in  $2\text{-Cat}$  rather than  $\mathbf{Cat}$ .

**Notation 4.1.1.2.** Throughout this section, we shall view the objects and 1-arrows of  $\mathbf{Braids}_{\leq 2}$  as objects and 1-arrows of  $\mathbf{Braids}$  via the functor

$$\mathbf{Braids}_{\leq 2} \xrightarrow{\text{can}_{\mathbf{Braids}}} \mathbf{Braids}.$$

Viewing the object 1 of  $\mathbf{Braids}_{\leq 2}$  as an object of  $\mathbf{Braids}$  in this way, we shall denote, for any integer  $n \geq 1$ , the object

$$\underbrace{1 \otimes_{\mathbf{Braids}} \cdots \otimes_{\mathbf{Braids}} 1}_n$$

of  $\mathbf{Braids}$  by  $n$ .

**Notation 4.1.1.3.** Let us denote the 1-arrow

$$2 \xrightarrow{\text{OverCrossing}} 2$$

of  $\mathbf{Braids}_{\leq 2}$

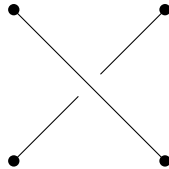

by  $\sigma$ .

**Notation 4.1.1.4.** Let us denote the 1-arrow

$$2 \xrightarrow{\text{UnderCrossing}} 2$$

of  $\mathbf{Braids}_{\leq 2}$

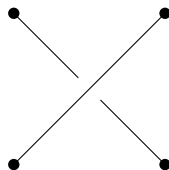



by  $\sigma^{-1}$ .

**Notation 4.1.1.5.** Let us denote by  $\partial(\text{LowerOverRightOver})$  the functor

$$\partial\mathcal{S} \longrightarrow \text{Braids}_{\leq 2}$$

corresponding to the following square in  $\text{Braids}_{\leq 2}$ .

$$\begin{array}{ccc} 2 & \xrightarrow{id} & 2 \\ id \downarrow & & \downarrow \sigma \\ 2 & \xrightarrow{\sigma} & 2 \end{array}$$

**Notation 4.1.1.6.** Let us denote by  $\partial(\text{UpperOverRightUnder})$  the functor

$$\partial\mathcal{S} \longrightarrow \text{Braids}_{\leq 2}$$

corresponding to the following square in  $\text{Braids}_{\leq 2}$ .

$$\begin{array}{ccc} 2 & \xrightarrow{\sigma} & 2 \\ id \downarrow & & \downarrow \sigma^{-1} \\ 2 & \xrightarrow{id} & 2 \end{array}$$

**Notation 4.1.1.7.** Let us denote by  $\partial(\text{LowerUnderRightUnder})$  the functor

$$\partial\mathcal{S} \longrightarrow \text{Braids}_{\leq 2}$$

corresponding to the following square in  $\text{Braids}_{\leq 2}$ .

$$\begin{array}{ccc} 2 & \xrightarrow{id} & 2 \\ id \downarrow & & \downarrow \sigma^{-1} \\ 2 & \xrightarrow{\sigma^{-1}} & 2 \end{array}$$

**Notation 4.1.1.8.** Let us denote by  $\partial(\text{UpperUnderRightOver})$  the functor

$$\partial\mathcal{S} \longrightarrow \text{Braids}_{\leq 2}$$

corresponding to the following square in  $\mathbf{Braids}_{\leq 2}$ .

$$\begin{array}{ccc} 2 & \xrightarrow{\sigma^{-1}} & 2 \\ id \downarrow & & \downarrow \sigma \\ 2 & \xrightarrow{id} & 2 \end{array}$$

**Notation 4.1.1.9.** Let us denote by  $\partial(\text{LowerOverLeftUnder})$  the functor

$$\partial\mathcal{S} \longrightarrow \mathbf{Braids}_{\leq 2}$$

corresponding to the following square in  $\mathbf{Braids}_{\leq 2}$ .

$$\begin{array}{ccc} 2 & \xrightarrow{id} & 2 \\ \sigma^{-1} \downarrow & & \downarrow id \\ 2 & \xrightarrow{\sigma} & 2 \end{array}$$

**Notation 4.1.1.10.** Let us denote by  $\partial(\text{UpperOverLeftOver})$  the functor

$$\partial\mathcal{S} \longrightarrow \mathbf{Braids}_{\leq 2}$$

corresponding to the following square in  $\mathbf{Braids}_{\leq 2}$ .

$$\begin{array}{ccc} 2 & \xrightarrow{\sigma} & 2 \\ \sigma \downarrow & & \downarrow id \\ 2 & \xrightarrow{id} & 2 \end{array}$$

**Notation 4.1.1.11.** Let us denote by  $\partial(\text{LowerUnderLeftOver})$  the functor

$$\partial\mathcal{S} \longrightarrow \mathbf{Braids}_{\leq 2}$$

corresponding to the following square in  $\mathbf{Braids}_{\leq 2}$ .

$$\begin{array}{ccc} 2 & \xrightarrow{id} & 2 \\ \sigma \downarrow & & \downarrow id \\ 2 & \xrightarrow{\sigma^{-1}} & 2 \end{array}$$

**Notation 4.1.1.12.** Let us denote by  $\partial(\text{UpperUnderLeftUnder})$  the functor

$$\partial\mathcal{S} \longrightarrow \text{Braids}_{\leq 2}$$

corresponding to the following square in  $\text{Braids}_{\leq 2}$ .

$$\begin{array}{ccc} 2 & \xrightarrow{\sigma^{-1}} & 2 \\ \sigma^{-1} \downarrow & & \downarrow id \\ 2 & \xrightarrow{id} & 2 \end{array}$$

**Notation 4.1.1.13.** Let

$$\begin{array}{ccc} \partial\mathcal{S} & \cdots & \partial\mathcal{S} \\ & \searrow & \swarrow \\ & \sqcup_8 \partial\mathcal{S} & \end{array}$$

$i_1^{\partial\mathcal{S}, \text{eight}}$        $i_8^{\partial\mathcal{S}, \text{eight}}$

be a diagram in 2-Cat which defines a coproduct of eight copies of  $\partial\mathcal{S}$ .

**Notation 4.1.1.14.** Let

$$\begin{array}{ccc} \mathcal{S} & \cdots & \mathcal{S} \\ & \searrow & \swarrow \\ & \sqcup_8 \mathcal{S} & \end{array}$$

$i_1^{\mathcal{S}, \text{eight}}$        $i_8^{\mathcal{S}, \text{eight}}$

be a diagram in 2-Cat which defines a coproduct of eight copies of  $\mathcal{S}$ .

**Notation 4.1.1.15.** Let

$$\sqcup_8 \partial\mathcal{S} \xrightarrow{\sqcup_8 \iota} \sqcup_8 \mathcal{S}$$

denote the canonical functor such that the following diagram in 2-Cat commutes for every  $1 \leq j \leq 8$ .

$$\begin{array}{ccc} \partial\mathcal{S} & \xrightarrow{i_j^{\partial\mathcal{S}, \text{eight}}} & \sqcup_8 \partial\mathcal{S} \\ \downarrow \iota & & \downarrow \sqcup_8 \iota \\ \mathcal{S} & \xrightarrow{i_j^{\mathcal{S}, \text{eight}}} & \sqcup_8 \mathcal{S} \end{array}$$

**Notation 4.1.1.16.** Let

$$\bigsqcup_8 \partial\mathcal{S} \xrightarrow{\bigsqcup_8 \text{generators}} \text{Braids}_{\leq 2}$$

denote the canonical functor such that the following hold.

(1) The following diagram in 2-Cat commutes.

$$\begin{array}{ccc} \partial\mathcal{S} & \xrightarrow{i_1^{\partial\mathcal{S}, \text{eight}}} & \bigsqcup_8 \partial\mathcal{S} \\ & \searrow \partial(\text{LowerOverRightOver}) & \downarrow \bigsqcup_8 \text{generators} \\ & & \text{Braids}_{\leq 2} \end{array}$$

(2) The following diagram in 2-Cat commutes.

$$\begin{array}{ccc} \partial\mathcal{S} & \xrightarrow{i_2^{\partial\mathcal{S}, \text{eight}}} & \bigsqcup_8 \partial\mathcal{S} \\ & \searrow \partial(\text{UpperOverRightUnder}) & \downarrow \bigsqcup_8 \text{generators} \\ & & \text{Braids}_{\leq 2} \end{array}$$

(3) The following diagram in 2-Cat commutes.

$$\begin{array}{ccc} \partial\mathcal{S} & \xrightarrow{i_3^{\partial\mathcal{S}, \text{eight}}} & \bigsqcup_8 \partial\mathcal{S} \\ & \searrow \partial(\text{LowerUnderRightUnder}) & \downarrow \bigsqcup \text{generators} \\ & & \text{Braids}_{\leq 2} \end{array}$$

(4) The following diagram in 2-Cat commutes.

$$\begin{array}{ccc} \partial\mathcal{S} & \xrightarrow{i_4^{\partial\mathcal{S}, \text{eight}}} & \bigsqcup_8 \partial\mathcal{S} \\ & \searrow \partial(\text{UpperUnderRightOver}) & \downarrow \bigsqcup_8 \text{generators} \\ & & \text{Braids}_{\leq 2} \end{array}$$

(5) The following diagram in 2-Cat commutes.

$$\begin{array}{ccc}
 \partial\mathcal{S} & \xrightarrow{i_5^{\cdot\partial\mathcal{S},eight}} & \bigsqcup_8 \partial\mathcal{S} \\
 \searrow \partial(\text{LowerOverLeftUnder}) & & \downarrow \bigsqcup_8 \text{generators} \\
 & & \text{Braids}_{\leq 2}
 \end{array}$$

(6) The following diagram in 2-Cat commutes.

$$\begin{array}{ccc}
 \partial\mathcal{S} & \xrightarrow{i_6^{\cdot\partial\mathcal{S},eight}} & \bigsqcup_8 \partial\mathcal{S} \\
 \searrow \partial(\text{UpperOverLeftOver}) & & \downarrow \bigsqcup_8 \text{generators} \\
 & & \text{Braids}_{\leq 2}
 \end{array}$$

(7) The following diagram in 2-Cat commutes.

$$\begin{array}{ccc}
 \partial\mathcal{S} & \xrightarrow{i_7^{\cdot\partial\mathcal{S},eight}} & \bigsqcup_8 \partial\mathcal{S} \\
 \searrow \partial(\text{LowerUnderLeftOver}) & & \downarrow \bigsqcup_8 \text{generators} \\
 & & \text{Braids}_{\leq 2}
 \end{array}$$

(8) The following diagram in 2-Cat commutes.

$$\begin{array}{ccc}
 \partial\mathcal{S} & \xrightarrow{i_8^{\cdot\partial\mathcal{S},eight}} & \bigsqcup_8 \partial\mathcal{S} \\
 \searrow \partial(\text{UpperUnderLeftUnder}) & & \downarrow \bigsqcup_8 \text{generators} \\
 & & \text{Braids}_{\leq 2}
 \end{array}$$

**Notation 4.1.1.17.** Let

$$\begin{array}{ccc}
 \bigsqcup_8 \partial\mathcal{S} & \xrightarrow{\bigsqcup_8 \iota} & \bigsqcup_8 \mathcal{S} \\
 \downarrow \bigsqcup_8 \text{generators} & & \downarrow r_0^{2\text{-Braids}_{\leq 2}^{\text{double}}} \\
 \text{Braids}_{\leq 2} & \xrightarrow{r_1^{2\text{-Braids}_{\leq 2}^{\text{double}}}} & 2\text{-Braids}_{\leq 2}^{\text{double}}
 \end{array}$$

be a co-cartesian square in 2-Cat.

**Notation 4.1.1.18.** We denote the 2-arrow of  $2\text{-Braids}_{\leq 2}^{\text{double}}$  corresponding to the functor

$$\mathcal{S} \xrightarrow{r_0 \circ i_1^{\mathcal{S}, \text{eight}}} 2\text{-Braids}_{\leq 2}^{\text{double}}$$

by `LowerOverRightOver`, or  $\sigma_{\text{LORO}}$  for short, and depict it as follows.

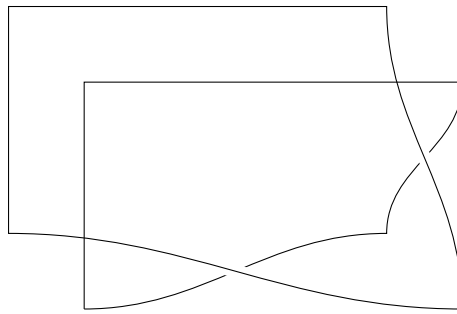

**Remark 4.1.1.19.** The previous figure depicts two planes, one of which is broken into two pieces. The plane which is unbroken is depicted in blue in the following figure.

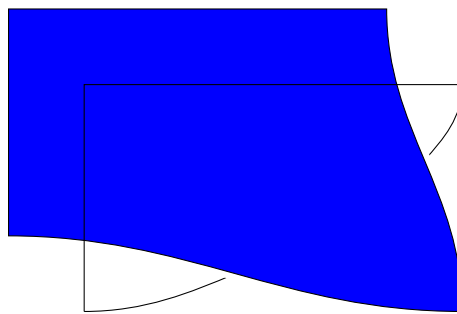

The other plane is broken where it appears to cross the first plane. One piece of the broken plane is depicted in green in the following figure.

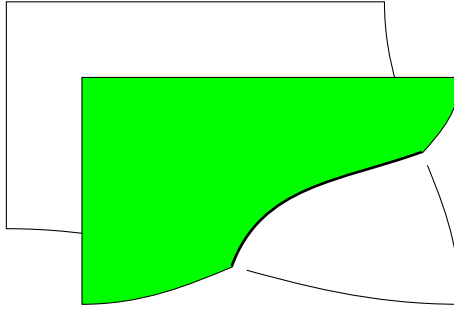

The second piece of the broken plane is depicted in green in the following figure. This piece actually lies behind the other plane as we look at it, and can only be seen because we have depicted the other plane as if it were hollow.

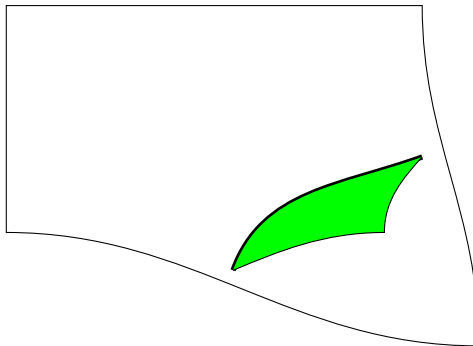

All other pictures of 2-braids that we draw are to be understood in this way.

**Notation 4.1.1.20.** We denote the 2-arrow of  $2\text{-Braids}_{\leq 2}^{\text{double}}$  corresponding to the functor

$$\mathcal{S} \xrightarrow[r_0]{\text{2-Braids}_{\leq 2}^{\text{double}} \circ i_2^{\mathcal{S}, \text{eight}}} 2\text{-Braids}_{\leq 2}^{\text{double}}$$

by UpperOverRightUnder, or  $\sigma_{\text{UORU}}$  for short, and depict it as follows.

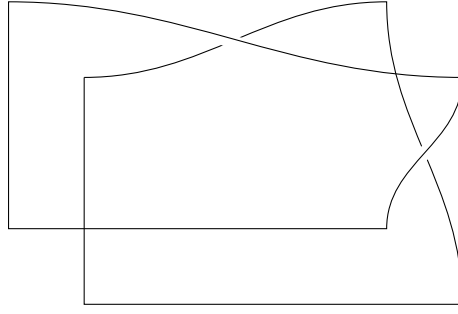

**Notation 4.1.1.21.** We denote the 2-arrow of  $2\text{-Braids}_{\leq 2}^{\text{double}}$  corresponding to the functor

$$\mathcal{S} \xrightarrow{r_0^{2\text{-Braids}_{\leq 2}^{\text{double}}} \circ i_3^{S, \text{eight}}} 2\text{-Braids}_{\leq 2}^{\text{double}}$$

by LowerUnderRightUnder, or  $\sigma_{\text{LURU}}$  for short, and depict it as follows.

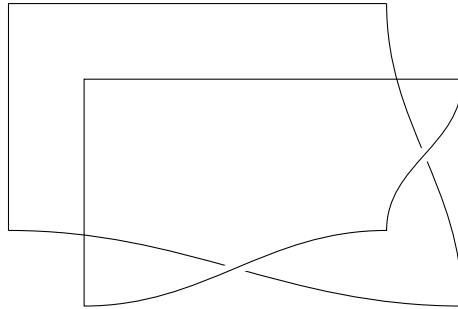

**Notation 4.1.1.22.** We denote the 2-arrow of  $2\text{-Braids}_{\leq 2}^{\text{double}}$  corresponding to the functor

$$\mathcal{S} \xrightarrow{r_0^{2\text{-Braids}_{\leq 2}^{\text{double}}} \circ i_4^{S, \text{eight}}} 2\text{-Braids}_{\leq 2}^{\text{double}}$$

by UpperUnderRightOver, or  $\sigma_{\text{UURO}}$  for short, and depict it as follows.

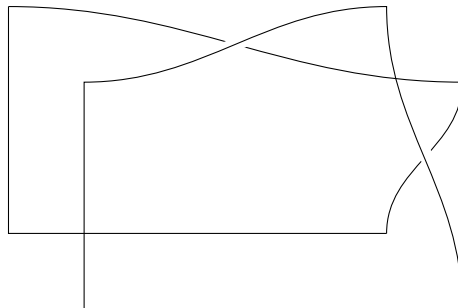



**Notation 4.1.1.23.** We denote the 2-arrow of  $2\text{-Braids}_{\leq 2}^{\text{double}}$  corresponding to the functor

$$\mathcal{S} \xrightarrow[r_0]{2\text{-Braids}_{\leq 2}^{\text{double}} \circ i_5^{\mathcal{S}, \text{eight}}} 2\text{-Braids}_{\leq 2}^{\text{double}}$$

by LowerOverLeftUnder, or  $\sigma_{\text{LOLU}}$  for short, and depict it as follows.

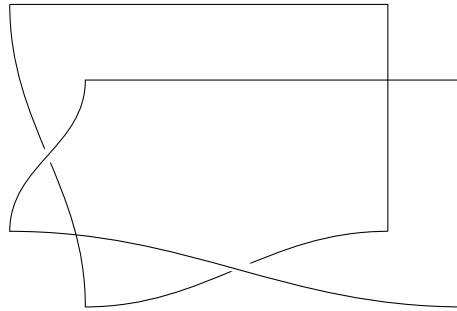

**Notation 4.1.1.24.** We denote the 2-arrow of  $2\text{-Braids}_{\leq 2}^{\text{double}}$  corresponding to the functor

$$\mathcal{S} \xrightarrow[r_0]{2\text{-Braids}_{\leq 2}^{\text{double}} \circ i_6^{\mathcal{S}, \text{eight}}} 2\text{-Braids}_{\leq 2}^{\text{double}}$$

by UpperOverLeftOver, or  $\sigma_{\text{UOLO}}$  for short, and depict it as follows.

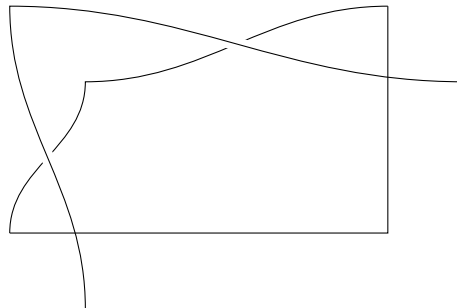

**Notation 4.1.1.25.** We denote the 2-arrow of  $2\text{-Braids}_{\leq 2}^{\text{double}}$  corresponding to the functor

$$\mathcal{S} \xrightarrow[r_0]{2\text{-Braids}_{\leq 2}^{\text{double}} \circ i_7^{\mathcal{S}, \text{eight}}} 2\text{-Braids}_{\leq 2}^{\text{double}}$$

by LowerUnderLeftOver, or  $\sigma_{\text{LULO}}$  for short, and depict it as follows.

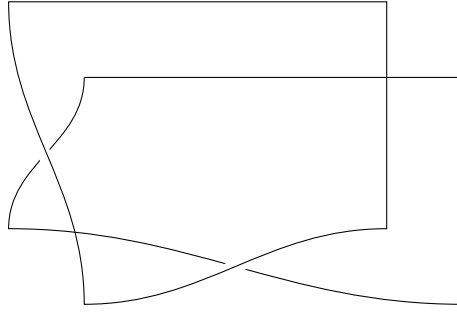

**Notation 4.1.1.26.** We denote the 2-arrow of  $2\text{-Braids}_{\leq 2}^{\text{double}}$  corresponding to the functor

$$\mathcal{S} \xrightarrow[r_0]{2\text{-Braids}_{\leq 2}^{\text{double}} \circ i_8^{\mathcal{S}, tw}} 2\text{-Braids}_{\leq 2}^{\text{double}}$$

by UpperUnderLeftUnder, or  $\sigma_{\text{UULU}}$  for short, and depict it as follows.

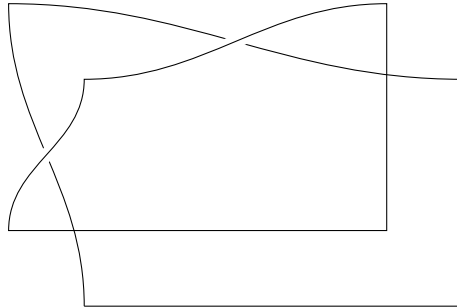

**Remark 4.1.1.27.** The definition of  $2\text{-Braids}_{\leq 2}^{\text{double}}$  can be thought of as follows. We begin with a category  $\text{Braids}_{\leq 2}$ . We then proceed as follows.

- (1) We add eight 2-arrows whose boundaries are configurations of arrows of  $\text{Braids}_{\leq 2}$ , of which either the top and left arrow, the top and right arrow, the bottom and right arrow, or the bottom and left arrow are identities.
- (2) We then add exactly those further 2-arrows that we need to have a cubical 2-category, namely compositions of arbitrary  $m \times n$  grids made up of the eight 2-arrows of (1), where  $m \geq 0$  and  $n \geq 0$  are integers, in which the horizontal sources and targets of the 2-arrows match in the  $m$  direction, and the vertical sources and targets of the 2-arrows match in the  $n$  direction.

**Notation 4.1.1.28.** We depict vertical composition in both  $2\text{-Braids}_{\leq 2}^{\text{double}}$  and  $2\text{-Braids}^{\text{double}}$  as vertical glueing. Thus, for instance, there is a 2-arrow

$$\sigma_{\text{LORO}} \circ_{\text{ver}} \sigma_{\text{UOLO}},$$

which we depict as follows,

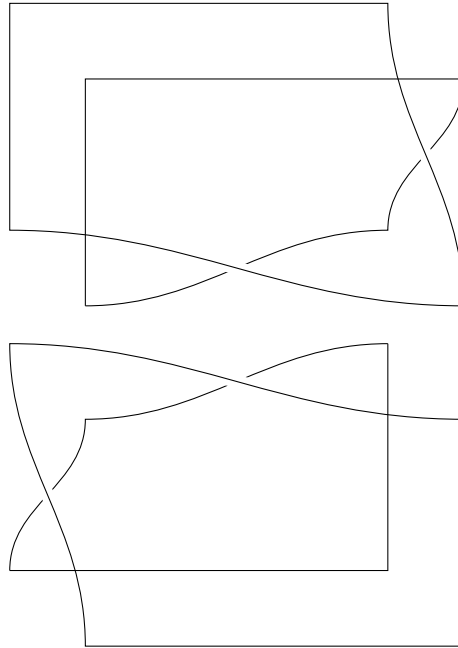

We depict horizontal composition in both  $2\text{-Braids}_{\leq 2}^{\text{double}}$  and  $2\text{-Braids}^{\text{double}}$  as horizontal glueing. Thus, for instance, there is a 2-arrow

$$\sigma_{\text{LORO}} \circ_{\text{hor}} \sigma_{\text{UOLO}},$$

which we depict as follows.

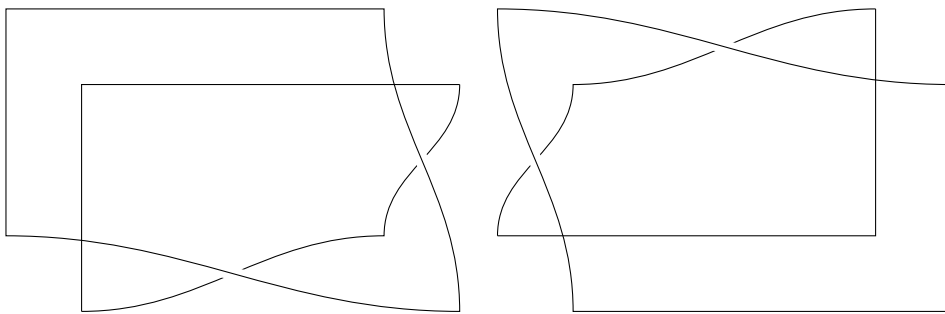

In each of these two figures, the two generating 2-arrows depicted should be imagined by the reader to be glued. We do not do so, as we feel the figures are clearer as they are. We shall depict 2-braids in this way throughout.

**Notation 4.1.1.29.** We shall view the objects and arrows of  $\text{Braids}_{\leq 2}$  as objects and 1-arrows of  $2\text{-Braids}_{\leq 2}^{\text{double}}$ , via the functor

$$\mathbf{Braids}_{\leq 2} \xrightarrow{r_1^{2\text{-Braids}_{\leq 2}^{\text{double}}}} 2\text{-Braids}_{\leq 2}^{\text{double}}.$$

**Notation 4.1.1.30.** Let

$$2\text{-Braids}_{\leq 2}^{\text{double}} \xleftarrow{p_1^{2\text{-Braids}_{\leq 2}^{\text{double}}}} 2\text{-Braids}_{\leq 2}^{\text{double}} \times 2\text{-Braids}_{\leq 2}^{\text{double}} \xrightarrow{p_2^{2\text{-Braids}_{\leq 2}^{\text{double}}}} 2\text{-Braids}_{\leq 2}^{\text{double}}$$

be a diagram in  $2\text{-Cat}$  which defines a binary product.

**Notation 4.1.1.31.** Let

$$1_{2\text{-Cat}} \xrightarrow{(1, 1)} 2\text{-Braids}_{\leq 2}^{\text{double}} \times 2\text{-Braids}_{\leq 2}^{\text{double}}$$

be the canonical functor such that the following diagram in  $2\text{-Cat}$  commutes.

$$\begin{array}{ccccc}
 & & 1_{2\text{-Cat}} & & \\
 & \swarrow & & \searrow & \\
 & 1 & & & 1 \\
 & & (1, 1) & & \\
 & \swarrow & \downarrow & \searrow & \\
 2\text{-Braids}_{\leq 2}^{\text{double}} & \xleftarrow{p_1^{2\text{-Braids}_{\leq 2}^{\text{double}}}} & 2\text{-Braids}_{\leq 2}^{\text{double}} \times 2\text{-Braids}_{\leq 2}^{\text{double}} & \xrightarrow{p_2^{2\text{-Braids}_{\leq 2}^{\text{double}}}} & 2\text{-Braids}_{\leq 2}^{\text{double}}
 \end{array}$$

**Definition 4.1.1.32.** The  $2$ -category of  $2$ -braids with double plane crossings is, appealing to Fact 2.2.1.4, the free strict monoidal cubical  $2$ -category on the monoidal datum  $\mathbb{M}_{2\text{-Braids}^{\text{double}}} = (1_{2\text{-Cat}}, 2\text{-Braids}_{\leq 2}^{\text{double}}, (1, 1), 2)$  internal to  $2\text{-Cat}$ .

**Notation 4.1.1.33.** We denote the  $2$ -category of  $2$ -braids with double plane crossings by  $2\text{-Braids}^{\text{double}}$ . We denote by  $\text{can}_{2\text{-Braids}^{\text{double}}}$  the canonical functor

$$2\text{-Braids}_{\leq 2} \longrightarrow 2\text{-Braids}^{\text{double}}.$$

**Remark 4.1.1.34.** The construction of the category  $2\text{-Braids}^{\text{double}}$  can be thought as taking the free strict monoidal category upon  $2\text{-Braids}_{\leq 2}$ , subject to the requirement that  $1 \otimes 1 = 2$ . The objects and  $1$ -arrows can be thought of in the same way as those of  $\mathbf{Braids}$ . The  $2$ -arrows of  $2\text{-Braids}^{\text{double}}$  can be thought of as built from the  $2$ -arrows of  $2\text{-Braids}_{\leq 2}^{\text{double}}$  by concatenation in the direction orthogonal to those we have chosen for depicting horizontal and vertical composition. Thus, for instance, we depict the  $2$ -arrow

$$\sigma_{\text{LORO}} \otimes id(1)$$

as follows.

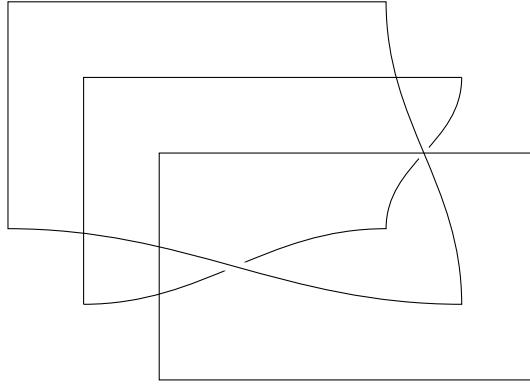

**Notation 4.1.1.35.** Appealing to Fact 2.2.1.4, let us denote by  $F(\partial\mathcal{S})$  the free strict monoidal cubical 2-category on  $\partial\mathcal{S}$ . Let us denote the canonical functor

$$\partial\mathcal{S} \longrightarrow F(\partial\mathcal{S})$$

by  $\text{can}_{\partial\mathcal{S}}$ .

**Notation 4.1.1.36.** Appealing to Fact 2.2.1.4, let us denote by  $F(\mathcal{S})$  the free strict monoidal cubical 2-category on  $\mathcal{S}$ . Let us denote the canonical functor

$$\mathcal{S} \longrightarrow F(\mathcal{S})$$

by  $\text{can}_{\mathcal{S}}$ .

**Notation 4.1.1.37.** Let us denote by

$$F(\partial\mathcal{S}) \xrightarrow{\iota} F(\mathcal{S})$$

the functor of strict monoidal 2-categories to which the functor

$$\partial\mathcal{S} \xrightarrow{\text{can}_{F(\mathcal{S})} \circ \iota} F(\mathcal{S})$$

gives rise, by means of the universal property of  $F(\partial\mathcal{S})$ .

**Notation 4.1.1.38.** Throughout the remainder of this section, let us denote by  $\sigma_1$  the 1-arrow

$$3 \xrightarrow{\text{OverCrossing} \otimes id} 3$$

of  $2\text{-Braids}^{\text{double}}$ .

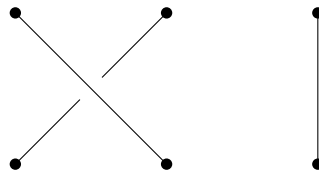

**Notation 4.1.1.39.** Throughout the remainder of this section, let us denote by  $\sigma_1^{-1}$  the 1-arrow

$$3 \xrightarrow{\text{UnderCrossing} \otimes id} 3$$

of  $2\text{-Braids}^{\text{double}}$ .

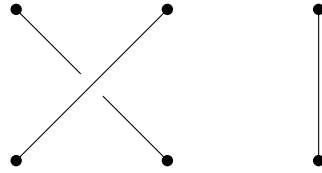

**Notation 4.1.1.40.** Throughout the remainder of this section, let us denote by  $\sigma_2$  the 1-arrow

$$3 \xrightarrow{id \otimes \text{OverCrossing}} 3$$

of  $2\text{-Braids}^{\text{double}}$ .

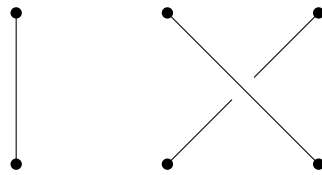

**Notation 4.1.1.41.** Throughout the remainder of this section, let us denote by  $\sigma_2^{-1}$  the 1-arrow

$$3 \xrightarrow{id \otimes \text{UnderCrossing}} 3$$

of  $2\text{-Braids}^{\text{double}}$ .

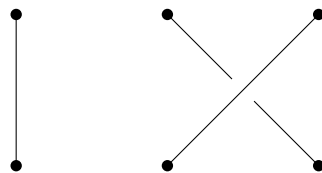

**Notation 4.1.1.42.** Let us denote by  $\partial(\text{TwoUnOnce})$  the canonical functor of strict monoidal cubical 2-categories

$$F(\partial\mathcal{S}) \longrightarrow 2\text{-Braids}^{\text{double}}$$

to which the functor

$$\partial\mathcal{S} \longrightarrow 2\text{-Braids}^{\text{double}}$$

corresponding to the following square of 1-arrows in  $2\text{-Braids}^{\text{double}}$  gives rise, by means of the universal property of  $F(\partial\mathcal{S})$ .

$$\begin{array}{ccc} 3 & \xrightarrow{\sigma_2} & 3 \\ \sigma_2 \circ \sigma_1 \downarrow & & \downarrow \sigma_2 \circ \sigma_1 \\ 3 & \xrightarrow{\sigma_1} & 3 \end{array}$$

**Notation 4.1.1.43.** Let us denote by  $\partial(\text{OneOnceTwice})$  the canonical functor of strict monoidal cubical 2-categories

$$F(\partial\mathcal{S}) \longrightarrow 2\text{-Braids}^{\text{double}}$$

to which the functor

$$\partial\mathcal{S} \longrightarrow 2\text{-Braids}^{\text{double}}$$

corresponding to the following square of 1-arrows in  $2\text{-Braids}^{\text{double}}$  gives rise, by means of the universal property of  $F(\partial\mathcal{S})$ .

$$\begin{array}{ccc} 3 & \xrightarrow{\sigma_1} & 3 \\ \sigma_1^{-1} \circ \sigma_2^{-1} \downarrow & & \downarrow \sigma_1^{-1} \circ \sigma_2^{-1} \\ 3 & \xrightarrow{\sigma_2} & 3 \end{array}$$

**Notation 4.1.1.44.** Let us denote by  $\partial(\text{TwoUnTwice})$  the canonical functor of strict monoidal cubical 2-categories

$$F(\partial\mathcal{S}) \longrightarrow 2\text{-Braids}^{\text{double}}$$

to which the functor

$$\partial\mathcal{S} \longrightarrow 2\text{-Braids}^{\text{double}}$$

corresponding to the following square of 1-arrows in  $2\text{-Braids}^{\text{double}}$  gives rise, by means of the universal property of  $F(\partial\mathcal{S})$ .

$$\begin{array}{ccc}
3 & \xrightarrow{\sigma_2^{-1}} & 3 \\
\sigma_2 \circ \sigma_1 \downarrow & & \downarrow \sigma_2 \circ \sigma_1 \\
3 & \xrightarrow{\sigma_1^{-1}} & 3
\end{array}$$

**Notation 4.1.1.45.** Let us denote by  $\partial(\text{One Twice Once})$  the canonical functor of strict monoidal cubical 2-categories

$$F(\partial\mathcal{S}) \longrightarrow 2\text{-Braids}^{\text{double}}$$

to which the functor

$$\partial\mathcal{S} \longrightarrow 2\text{-Braids}^{\text{double}}$$

corresponding to the following square of 1-arrows in  $2\text{-Braids}^{\text{double}}$  gives rise, by means of the universal property of  $F(\partial\mathcal{S})$ .

$$\begin{array}{ccc}
3 & \xrightarrow{\sigma_1^{-1}} & 3 \\
\sigma_1^{-1} \circ \sigma_2^{-1} \downarrow & & \downarrow \sigma_1^{-1} \circ \sigma_2^{-1} \\
3 & \xrightarrow{\sigma_2^{-1}} & 3
\end{array}$$

**Notation 4.1.1.46.** Let us denote by  $\partial(\text{Two Once Un})$  the canonical functor of strict monoidal cubical 2-categories

$$F(\partial\mathcal{S}) \longrightarrow 2\text{-Braids}^{\text{double}}$$

to which the functor

$$\partial\mathcal{S} \longrightarrow 2\text{-Braids}^{\text{double}}$$

corresponding to the following square of 1-arrows in  $2\text{-Braids}^{\text{double}}$  gives rise, by means of the universal property of  $F(\partial\mathcal{S})$ .

$$\begin{array}{ccc}
3 & \xrightarrow{\sigma_2} & 3 \\
\sigma_2 \circ \sigma_1^{-1} \downarrow & & \downarrow \sigma_2^{-1} \circ \sigma_1 \\
3 & \xrightarrow{\sigma_1} & 3
\end{array}$$



**Notation 4.1.1.47.** Let us denote by  $\partial(\text{OneUnTwice})$  the canonical functor of strict monoidal cubical 2-categories

$$F(\partial\mathcal{S}) \longrightarrow 2\text{-Braids}^{\text{double}}$$

to which the functor

$$\partial\mathcal{S} \longrightarrow 2\text{-Braids}^{\text{double}}$$

corresponding to the following square of 1-arrows in  $2\text{-Braids}^{\text{double}}$  gives rise, by means of the universal property of  $F(\partial\mathcal{S})$ .

$$\begin{array}{ccc} 3 & \xrightarrow{\sigma_1} & 3 \\ \sigma_1 \circ \sigma_2^{-1} \downarrow & & \downarrow \sigma_1^{-1} \circ \sigma_2 \\ 3 & \xrightarrow{\sigma_2} & 3 \end{array}$$

**Notation 4.1.1.48.** Let us denote by  $\partial(\text{TwoTwiceUn})$  the canonical functor of strict monoidal cubical 2-categories

$$F(\partial\mathcal{S}) \longrightarrow 2\text{-Braids}^{\text{double}}$$

to which the functor

$$\partial\mathcal{S} \longrightarrow 2\text{-Braids}^{\text{double}}$$

corresponding to the following square of 1-arrows in  $2\text{-Braids}^{\text{double}}$  gives rise, by means of the universal property of  $F(\partial\mathcal{S})$ .

$$\begin{array}{ccc} 3 & \xrightarrow{\sigma_2} & 3 \\ \sigma_2^{-1} \circ \sigma_1^{-1} \downarrow & & \downarrow \sigma_2^{-1} \circ \sigma_1^{-1} \\ 3 & \xrightarrow{\sigma_1} & 3 \end{array}$$

**Notation 4.1.1.49.** Let us denote by  $\partial(\text{OneUnOnce})$  the canonical functor of strict monoidal cubical 2-categories

$$F(\partial\mathcal{S}) \longrightarrow 2\text{-Braids}^{\text{double}}$$

to which the functor

$$\partial\mathcal{S} \longrightarrow 2\text{-Braids}^{\text{double}}$$

corresponding to the following square of 1-arrows in  $2\text{-Braids}^{\text{double}}$  gives rise, by means of the universal property of  $F(\partial\mathcal{S})$ .

$$\begin{array}{ccc} 3 & \xrightarrow{\sigma_1} & 3 \\ \sigma_1 \circ \sigma_2 \downarrow & & \downarrow \sigma_1 \circ \sigma_2 \\ 3 & \xrightarrow{\sigma_2} & 3 \end{array}$$

**Notation 4.1.1.50.** Let us denote by  $\partial(\text{TwoOnceTwice})$  the canonical functor of strict monoidal cubical 2-categories

$$F(\partial\mathcal{S}) \longrightarrow 2\text{-Braids}^{\text{double}}$$

to which the functor

$$\partial\mathcal{S} \longrightarrow 2\text{-Braids}^{\text{double}}$$

corresponding to the following square of 1-arrows in  $2\text{-Braids}^{\text{double}}$  gives rise, by means of the universal property of  $F(\partial\mathcal{S})$ .

$$\begin{array}{ccc} 3 & \xrightarrow{\sigma_2^{-1}} & 3 \\ \sigma_2^{-1} \circ \sigma_1 \downarrow & & \downarrow \sigma_2 \circ \sigma_1^{-1} \\ 3 & \xrightarrow{\sigma_1^{-1}} & 3 \end{array}$$

**Notation 4.1.1.51.** Let us denote by  $\partial(\text{OneTwiceUn})$  the canonical functor of strict monoidal cubical 2-categories

$$F(\partial\mathcal{S}) \longrightarrow 2\text{-Braids}^{\text{double}}$$

to which the functor

$$\partial\mathcal{S} \longrightarrow 2\text{-Braids}^{\text{double}}$$

corresponding to the following square of 1-arrows in  $2\text{-Braids}^{\text{double}}$  gives rise, by means of the universal property of  $F(\partial\mathcal{S})$ .

$$\begin{array}{ccc}
3 & \xrightarrow{\sigma_1^{-1}} & 3 \\
\sigma_1^{-1} \circ \sigma_2 \downarrow & & \downarrow \sigma_1 \circ \sigma_2^{-1} \\
3 & \xrightarrow{\sigma_2^{-1}} & 3
\end{array}$$

**Notation 4.1.1.52.** Let us denote by  $\partial(\text{TwoTwiceOnce})$  the canonical functor of strict monoidal cubical 2-categories

$$F(\partial\mathcal{S}) \longrightarrow 2\text{-Braids}^{\text{double}}$$

to which the functor

$$\partial\mathcal{S} \longrightarrow 2\text{-Braids}^{\text{double}}$$

corresponding to the following square of 1-arrows in  $2\text{-Braids}^{\text{double}}$  gives rise, by means of the universal property of  $F(\partial\mathcal{S})$ .

$$\begin{array}{ccc}
3 & \xrightarrow{\sigma_2^{-1}} & 3 \\
\sigma_2^{-1} \circ \sigma_1^{-1} \downarrow & & \downarrow \sigma_2^{-1} \circ \sigma_1^{-1} \\
3 & \xrightarrow{\sigma_1^{-1}} & 3
\end{array}$$

**Notation 4.1.1.53.** Let us denote by  $\partial(\text{OneOnceUn})$  the canonical functor of strict monoidal cubical 2-categories

$$F(\partial\mathcal{S}) \longrightarrow 2\text{-Braids}^{\text{double}}$$

to which the functor

$$\partial\mathcal{S} \longrightarrow 2\text{-Braids}^{\text{double}}$$

corresponding to the following square of 1-arrows in  $2\text{-Braids}^{\text{double}}$  gives rise, by means of the universal property of  $F(\partial\mathcal{S})$ .

$$\begin{array}{ccc}
3 & \xrightarrow{\sigma_1^{-1}} & 3 \\
\sigma_1 \circ \sigma_2 \downarrow & & \downarrow \sigma_1 \circ \sigma_2 \\
3 & \xrightarrow{\sigma_2^{-1}} & 3
\end{array}$$

**Notation 4.1.1.54.** Let

$$\begin{array}{ccc}
 F(\partial\mathcal{S}) & \cdots & F(\partial\mathcal{S}) \\
 \searrow & & \swarrow \\
 \downarrow i_1^{F(\partial\mathcal{S}),twelve} & & \downarrow i_{12}^{F(\partial\mathcal{S}),twelve} \\
 & \sqcup_{12} F(\partial\mathcal{S}) & 
 \end{array}$$

be a diagram in  $\text{Mon}(2\text{-Cat})$  which defines a coproduct of twelve copies of  $F(\partial\mathcal{S})$ .

**Notation 4.1.1.55.** Let

$$\begin{array}{ccc}
 F(\mathcal{S}) & \cdots & F(\mathcal{S}) \\
 \searrow & & \swarrow \\
 \downarrow i_1^{F(\mathcal{S}),twelve} & & \downarrow i_{12}^{F(\mathcal{S}),twelve} \\
 & \sqcup_8 F(\mathcal{S}) & 
 \end{array}$$

be a diagram in  $\text{Mon}(2\text{-Cat})$  which defines a coproduct of twelve copies of  $F(\mathcal{S})$ .

**Notation 4.1.1.56.** Let

$$\sqcup_{12} F(\partial\mathcal{S}) \xrightarrow{\sqcup_{12} \iota} \sqcup_{12} F(\mathcal{S})$$

denote the canonical functor of strict monoidal cubical 2-categories such that the following diagram in  $2\text{-Cat}$  commutes for every  $1 \leq j \leq 12$ .

$$\begin{array}{ccc}
 F(\partial\mathcal{S}) & \xrightarrow{i_j^{F(\partial\mathcal{S}),twelve}} & \sqcup_{12} F(\partial\mathcal{S}) \\
 \downarrow \iota & & \downarrow \sqcup_8 \iota \\
 F(\mathcal{S}) & \xrightarrow{i_j^{F(\mathcal{S}),twelve}} & \sqcup_{12} F(\mathcal{S})
 \end{array}$$

**Notation 4.1.1.57.** Let

$$\sqcup_{12} F(\partial\mathcal{S}) \xrightarrow{\sqcup \text{generators}} 2\text{-Braids}^{\text{double}}$$

denote the canonical functor of strict monoidal cubical 2-categories such that the following hold.

- (1) The following diagram in  $\text{Mon}(2\text{-Cat})$  commutes.

$$\begin{array}{ccc}
F(\partial\mathcal{S}) & \xrightarrow{i_1^{F(\partial\mathcal{S}),twelve}} & \bigsqcup_{12} F(\partial\mathcal{S}) \\
\searrow \partial(\text{TwoUnOnce}) & & \downarrow \bigsqcup \text{generators} \\
& & 2\text{-Braids}^{\text{double}}
\end{array}$$

(2) The following diagram in  $\text{Mon}(2\text{-Cat})$  commutes.

$$\begin{array}{ccc}
F(\partial\mathcal{S}) & \xrightarrow{i_2^{F(\partial\mathcal{S}),twelve}} & \bigsqcup_{12} F(\partial\mathcal{S}) \\
\searrow \partial(\text{OneOnceTwice}) & & \downarrow \bigsqcup \text{generators} \\
& & 2\text{-Braids}^{\text{double}}
\end{array}$$

(3) The following diagram in  $\text{Mon}(2\text{-Cat})$  commutes.

$$\begin{array}{ccc}
F(\partial\mathcal{S}) & \xrightarrow{i_3^{F(\partial\mathcal{S}),twelve}} & \bigsqcup_{12} F(\partial\mathcal{S}) \\
\searrow \partial(\text{TwoUnTwice}) & & \downarrow \bigsqcup \text{generators} \\
& & 2\text{-Braids}^{\text{double}}
\end{array}$$

(4) The following diagram in  $\text{Mon}(2\text{-Cat})$  commutes.

$$\begin{array}{ccc}
F(\partial\mathcal{S}) & \xrightarrow{i_4^{F(\partial\mathcal{S}),twelve}} & \bigsqcup_{12} F(\partial\mathcal{S}) \\
\searrow \partial(\text{OneTwiceOnce}) & & \downarrow \bigsqcup \text{generators} \\
& & 2\text{-Braids}^{\text{double}}
\end{array}$$

(5) The following diagram in  $\text{Mon}(2\text{-Cat})$  commutes.

$$\begin{array}{ccc}
F(\partial\mathcal{S}) & \xrightarrow{i_5^{F(\partial\mathcal{S}),twelve}} & \bigsqcup_{12} F(\partial\mathcal{S}) \\
\searrow \partial(\text{TwoOnceUn}) & & \downarrow \bigsqcup \text{generators} \\
& & 2\text{-Braids}^{\text{double}}
\end{array}$$

(6) The following diagram in  $\text{Mon}(2\text{-Cat})$  commutes.

$$\begin{array}{ccc}
 F(\partial\mathcal{S}) & \xrightarrow{i_6^{F(\partial\mathcal{S}),twelve}} & \bigsqcup_{12} F(\partial\mathcal{S}) \\
 \searrow \partial(\text{OneUnTwice}) & & \downarrow \bigsqcup \text{generators} \\
 & & 2\text{-Braids}^{\text{double}}
 \end{array}$$

(7) The following diagram in  $\text{Mon}(2\text{-Cat})$  commutes.

$$\begin{array}{ccc}
 F(\partial\mathcal{S}) & \xrightarrow{i_7^{F(\partial\mathcal{S}),twelve}} & \bigsqcup_{12} F(\partial\mathcal{S}) \\
 \searrow \partial(\text{TwoTwiceUn}) & & \downarrow \bigsqcup \text{generators} \\
 & & 2\text{-Braids}^{\text{double}}
 \end{array}$$

(8) The following diagram in  $\text{Mon}(2\text{-Cat})$  commutes.

$$\begin{array}{ccc}
 F(\partial\mathcal{S}) & \xrightarrow{i_8^{F(\partial\mathcal{S}),twelve}} & \bigsqcup_{12} F(\partial\mathcal{S}) \\
 \searrow \partial(\text{OneUnOnce}) & & \downarrow \bigsqcup \text{generators} \\
 & & 2\text{-Braids}^{\text{double}}
 \end{array}$$

(9) The following diagram in  $\text{Mon}(2\text{-Cat})$  commutes.

$$\begin{array}{ccc}
 F(\partial\mathcal{S}) & \xrightarrow{i_9^{F(\partial\mathcal{S}),twelve}} & \bigsqcup_{12} F(\partial\mathcal{S}) \\
 \searrow \partial(\text{TwoOnceTwice}) & & \downarrow \bigsqcup \text{generators} \\
 & & 2\text{-Braids}^{\text{double}}
 \end{array}$$

(10) The following diagram in  $\text{Mon}(2\text{-Cat})$  commutes.

$$\begin{array}{ccc}
F(\partial\mathcal{S}) & \xrightarrow{i_{10}^{F(\partial\mathcal{S}),twelve}} & \bigsqcup_{12} F(\partial\mathcal{S}) \\
& \searrow & \downarrow \bigsqcup \text{generators} \\
\partial(\text{OneTwiceUn}) & & 2\text{-Braids}^{\text{double}}
\end{array}$$

(11) The following diagram in  $\text{Mon}(2\text{-Cat})$  commutes.

$$\begin{array}{ccc}
F(\partial\mathcal{S}) & \xrightarrow{i_{11}^{F(\partial\mathcal{S}),twelve}} & \bigsqcup_{12} F(\partial\mathcal{S}) \\
& \searrow & \downarrow \bigsqcup \text{generators} \\
\partial(\text{TwoTwiceOnce}) & & 2\text{-Braids}^{\text{double}}
\end{array}$$

(12) The following diagram in  $\text{Mon}(2\text{-Cat})$  commutes.

$$\begin{array}{ccc}
F(\partial\mathcal{S}) & \xrightarrow{i_{12}^{F(\partial\mathcal{S}),twelve}} & \bigsqcup_{12} F(\partial\mathcal{S}) \\
& \searrow & \downarrow \bigsqcup \text{generators} \\
\partial(\text{OneOnceUn}) & & 2\text{-Braids}^{\text{double}}
\end{array}$$

**Notation 4.1.1.58.** Let

$$\begin{array}{ccc}
\bigsqcup_{12} F(\partial\mathcal{S}) & \xrightarrow{\bigsqcup_{12} \iota} & \bigsqcup_{12} F(\mathcal{S}) \\
\downarrow \bigsqcup_{12} \text{generators} & & \downarrow r_0^{2\text{-Braids}} \\
2\text{-Braids}^{\text{double}} & \xrightarrow{r_1^{2\text{-Braids}}} & 2\text{-Braids}
\end{array}$$

be a co-cartesian square in  $\text{Mon}(2\text{-Cat})$ .

**Terminology 4.1.1.59.** We refer to  $2\text{-Braids}$  as the *2-category of 2-braids*.

**Notation 4.1.1.60.** We denote the functor of strict monoidal 2-categories

$$2\text{-Braids}^{\text{double}} \xrightarrow{r_1^{2\text{-Braids}}} 2\text{-Braids}$$

by  $\text{can}_{2\text{-Braids}}$ .

**Notation 4.1.1.61.** We denote the 2-arrow of 2-Braids corresponding to the functor

$$\mathcal{S} \xrightarrow{r_0^{2\text{-Braids}} \circ i_1^{F(S), \text{twelve}} \circ \text{can}_{\mathcal{S}}} 2\text{-Braids}^{\text{double}}$$

by `TwoUnOnce`, or  $\sigma_{2\text{UO}}$  for short, and depict it as follows.

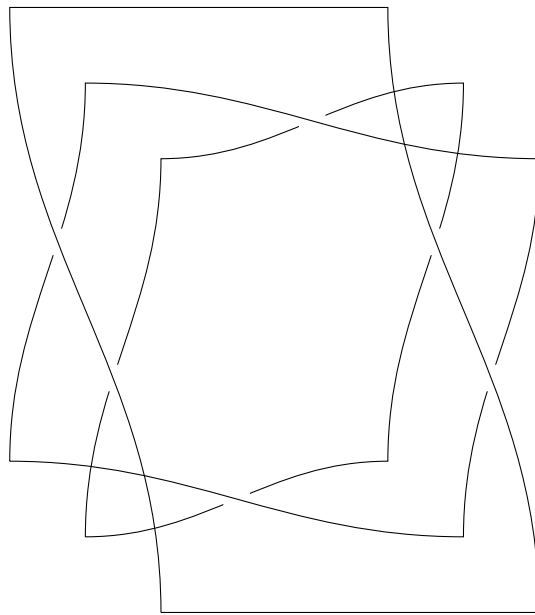

**Notation 4.1.1.62.** We denote the 2-arrow of 2-Braids corresponding to the functor

$$\mathcal{S} \xrightarrow{r_0^{2\text{-Braids}} \circ i_2^{F(S), \text{twelve}} \circ \text{can}_{\mathcal{S}}} 2\text{-Braids}^{\text{double}}$$

by `OneOnceTwice`, or  $\sigma_{1\text{OT}}$  for short, and depict it as follows.



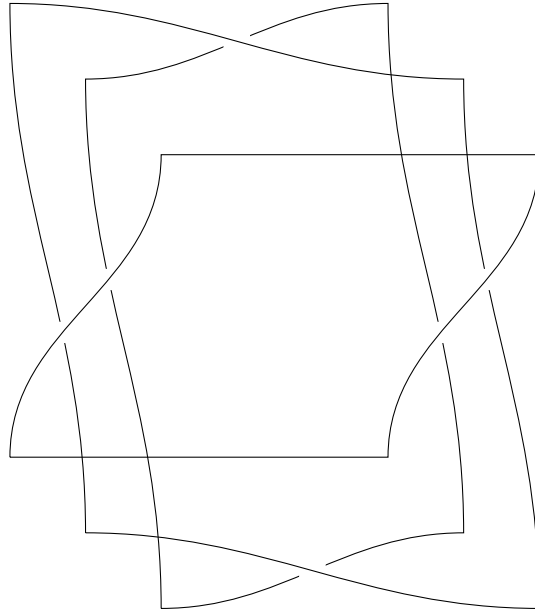

**Notation 4.1.1.63.** We denote the 2-arrow of 2-Braids corresponding to the functor

$$\mathcal{S} \xrightarrow{r_0^{2\text{-Braids}} \circ i_3^{F(\mathcal{S}), \text{twelve}} \circ \text{can}_{\mathcal{S}}} 2\text{-Braids}^{\text{double}}$$

by TwoUnTwice, or  $\sigma_{2UT}$  for short, and depict it as follows.

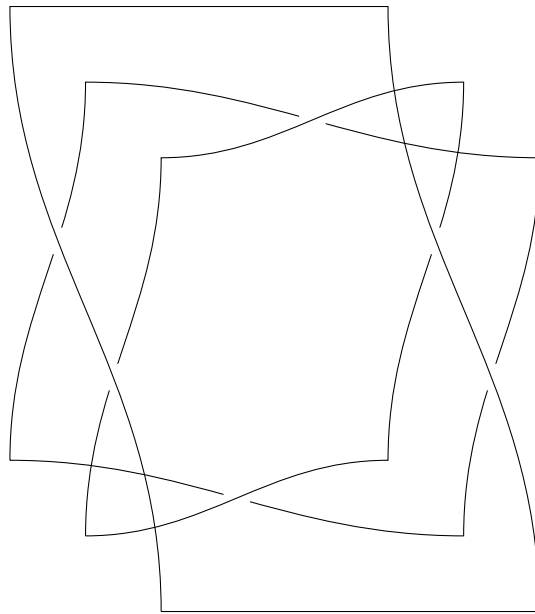

**Notation 4.1.1.64.** We denote the 2-arrow of 2-Braids corresponding to the functor

$$\mathcal{S} \xrightarrow{r_0^{2\text{-Braids}} \circ i_4^{F(\mathcal{S}), \text{twelve}} \circ \text{can}_{\mathcal{S}}} 2\text{-Braids}^{\text{double}}$$

by OneTwiceOnce, or  $\sigma_{1\text{TO}}$  for short, and depict it as follows.

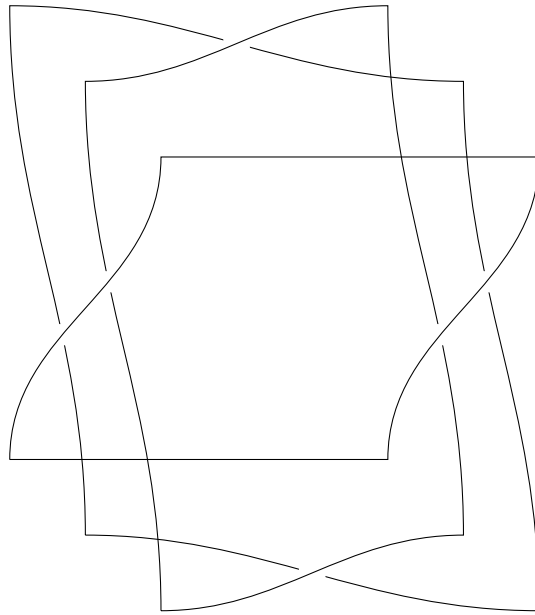

**Notation 4.1.1.65.** We denote the 2-arrow of 2-Braids corresponding to the functor

$$\mathcal{S} \xrightarrow{r_0^{2\text{-Braids}} \circ i_5^{F(\mathcal{S}), \text{twelve}} \circ \text{can}_{\mathcal{S}}} 2\text{-Braids}^{\text{double}}$$

by TwoOnceUn, or  $\sigma_{2\text{OU}}$  for short, and depict it as follows.

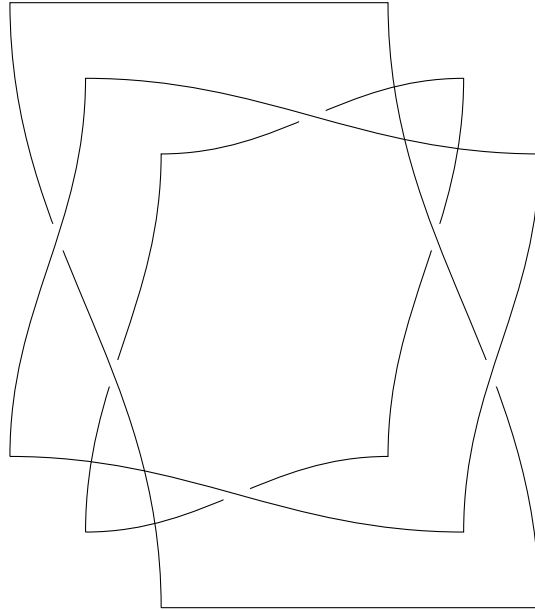

**Notation 4.1.1.66.** We denote the 2-arrow of 2-Braids corresponding to the functor

$$\mathcal{S} \xrightarrow{r_0^{2\text{-Braids}} \circ \iota_6^{F(\mathcal{S}), \text{twelve}} \circ \text{can}_{\mathcal{S}}} 2\text{-Braids}^{\text{double}}$$

by OneUnTwice, or  $\sigma_{1UT}$  for short, and depict it as follows.

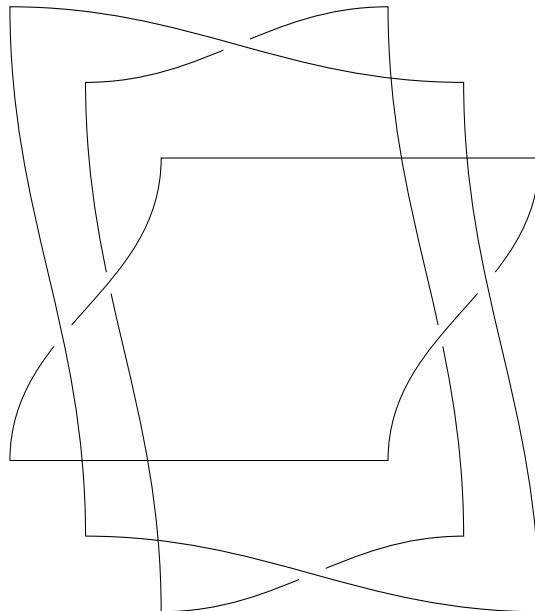

**Notation 4.1.1.67.** We denote the 2-arrow of 2-Braids corresponding to the functor

$$\mathcal{S} \xrightarrow{r_0^{2\text{-Braids}} \circ i_7^{F(\mathcal{S}), \text{twelve}} \circ \text{can}_{\mathcal{S}}} 2\text{-Braids}^{\text{double}}$$

by TwoTwiceUn, or  $\sigma_{2\text{TU}}$  for short, and depict it as follows.

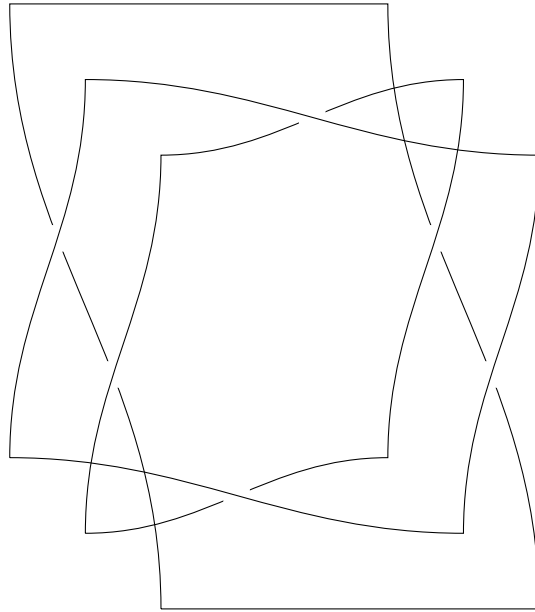

**Notation 4.1.1.68.** We denote the 2-arrow of 2-Braids corresponding to the functor

$$\mathcal{S} \xrightarrow{r_0^{2\text{-Braids}} \circ i_8^{F(\mathcal{S}), \text{twelve}} \circ \text{can}_{\mathcal{S}}} 2\text{-Braids}^{\text{double}}$$

by OneUnOnce, or  $\sigma_{1\text{UO}}$  for short, and depict it as follows.

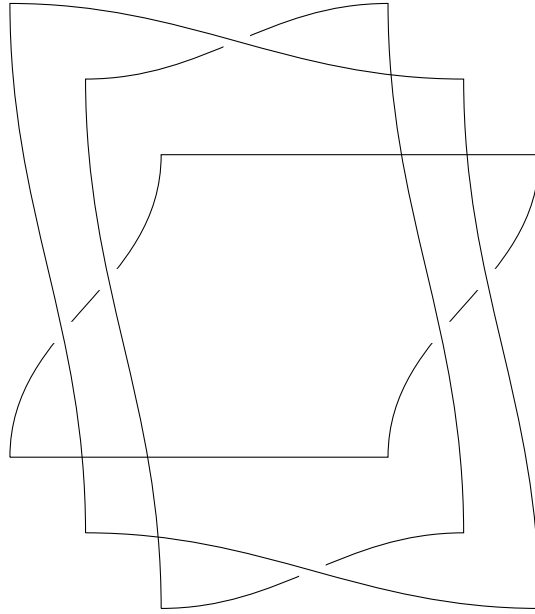

**Notation 4.1.1.69.** We denote the 2-arrow of 2-Braids corresponding to the functor

$$\mathcal{S} \xrightarrow{r_0^{2\text{-Braids}} \circ i_9^{F(\mathcal{S}), \text{twelve}} \circ \text{can}_{\mathcal{S}}} 2\text{-Braids}^{\text{double}}$$

by TwoOnceTwice, or  $\sigma_{2\text{OT}}$  for short, and depict it as follows.

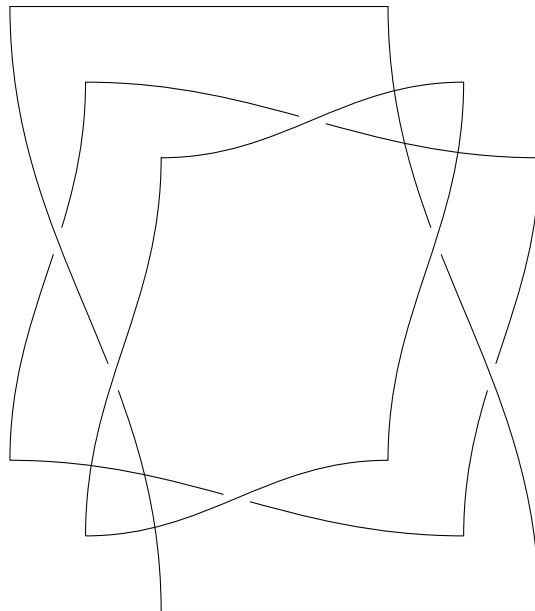

**Notation 4.1.1.70.** We denote the 2-arrow of 2-Braids corresponding to the functor

$$\mathcal{S} \xrightarrow{r_0^{2\text{-Braids}} \circ i_{10}^{F(\mathcal{S}),twelve} \circ \text{can}_{\mathcal{S}}} 2\text{-Braids}^{\text{double}}$$

by `OneTwiceUn`, or  $\sigma_{1TU}$  for short, and depict it as follows.

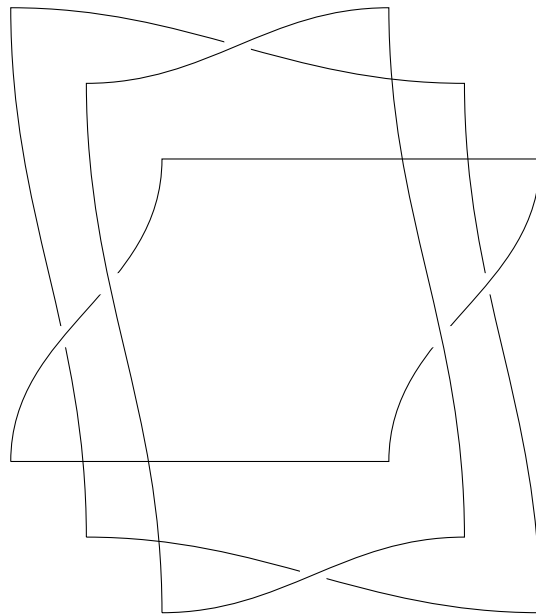

**Notation 4.1.1.71.** We denote the 2-arrow of `2-Braids` corresponding to the functor

$$\mathcal{S} \xrightarrow{r_0^{2\text{-Braids}} \circ i_{11}^{F(\mathcal{S}),twelve} \circ \text{can}_{\mathcal{S}}} 2\text{-Braids}^{\text{double}}$$

by `TwoTwiceOnce`, or  $\sigma_{2TO}$  for short, and depict it as follows.

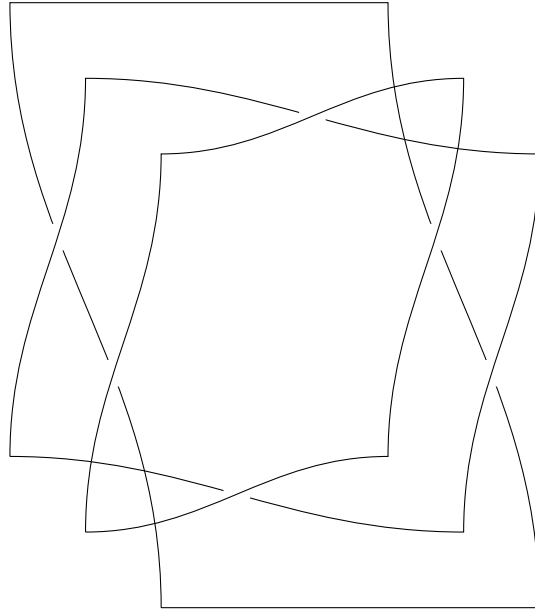

**Notation 4.1.1.72.** We denote the 2-arrow of 2-Braids corresponding to the functor

$$\mathcal{S} \xrightarrow{r_0^{2\text{-Braids}} \circ i_{12}^{F(\mathcal{S}), \text{twelve}} \circ \text{can}_{\mathcal{S}}} 2\text{-Braids}^{\text{double}}$$

by OneOnceUn, or  $\sigma_{10U}$  for short, and depict it as follows.

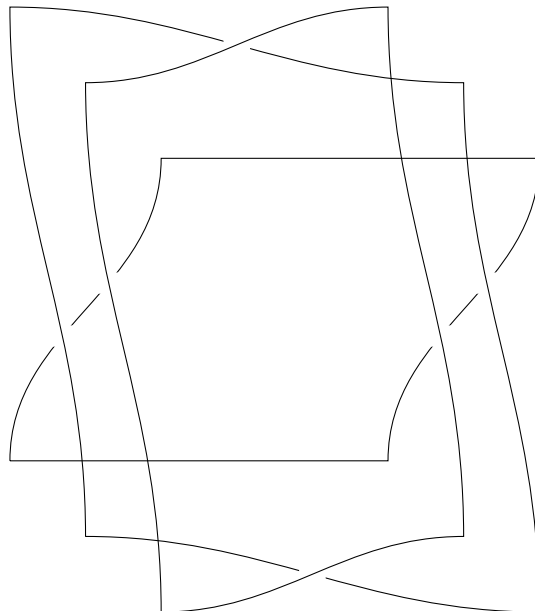

**Remark 4.1.1.73.** The names we have given the 2-arrows of 2-Braids of Notation 4.1.1.61 – Notation 4.1.1.72 are determined as follows.

- (1) The first of the three words refers to whether the north edge has a crossing between the first and second strand (**One**) or between the second and third strand (**Two**).
- (2) The second of the three words refers to whether the plane whose north edge has source 1 is unbroken (**Un**), broken by one of the other planes (**Once**), or broken by both of the other planes (**Twice**).
- (3) The third of the three words refers to whether the plane whose north edge has source 2 is unbroken (**Un**), broken by one of the other planes (**Once**), or broken by both of the other planes (**Twice**).

**Remark 4.1.1.74.** The construction of the category **2-Braids** can be thought as freely adding twelve 2-arrows to **2-Braids<sup>double</sup>**. The objects and 1-arrows of **2-Braids** can be thought of in the same way as of those of **Braids**.

The 2-arrows of **2-Braids** can be thought of as built from the twenty 2-arrows defined in Notation 4.1.1.18 – 4.1.1.26 and Notation 4.1.1.61 – Notation 4.1.1.72 by vertical glueing, horizontal glueing, and concatenation in the direction orthogonal to those we have chosen to depict vertical and horizontal glueing.

**Remark 4.1.1.75.** The underlying category of **2-Braids** is exactly **Braids**. We shall, not, however, need this in our formal work, and omit a proof.

## 4.1.2. 2-categories of 2-braids up to isotopy

**Notation 4.1.2.1.** Let

$$F(\mathcal{S}) \xrightarrow{\text{Bubble}_{\text{one}}(\text{one half})} \mathbf{2}\text{-Braids}$$

be the functor of strict monoidal cubical 2-categories to which, by means of the universal property of  $F(\mathcal{S})$ , the functor

$$\mathcal{S} \longrightarrow \mathbf{2}\text{-Braids}$$

corresponding to the 2-arrow of **2-Braids** obtained by pasting together the following 2-arrows of **2-Braids** gives rise.



$$\begin{array}{ccccc}
2 & \xrightarrow{id(2)} & 2 & \xrightarrow{id(2)} & 2 \\
id(2) \downarrow & & \sigma \downarrow & & id(2) \downarrow \\
& \sigma_{LORO} & & \sigma_{LULO} & \\
2 & \xrightarrow{\sigma} & 2 & \xrightarrow{\sigma^{-1}} & 2 \\
id(2) \downarrow & & \sigma^{-1} \downarrow & & id(2) \downarrow \\
& \sigma_{UORU} & & \sigma_{UULU} & \\
2 & \xrightarrow{id(2)} & 2 & \xrightarrow{id(2)} & 2
\end{array}$$

**Notation 4.1.2.2.** Let

$$F(\mathcal{S}) \xrightarrow{\text{Bubble}_{\text{one}}(\text{other half})} \text{2-Braids}$$

be the functor of strict monoidal cubical 2-categories to which, by means of the universal property of  $F(\mathcal{S})$ , the functor

$$\mathcal{S} \longrightarrow \text{2-Braids}$$

corresponding to the 2-arrow

$$\begin{array}{ccc}
2 & \xrightarrow{id(2)} & 2 \\
id(2) \downarrow & id(id(2)) & \downarrow id(2) \\
2 & \xrightarrow{id(2)} & 2
\end{array}$$

of 2-Braids gives rise.

**Remark 4.1.2.3.** The 2-arrows  $\text{Bubble}_{\text{one}}(\text{one half})$  and  $\text{Bubble}_{\text{one}}(\text{other half})$  of 2-Braids express algebraically the two halves of the Roseman move known as the bubble move, which allows us to replace

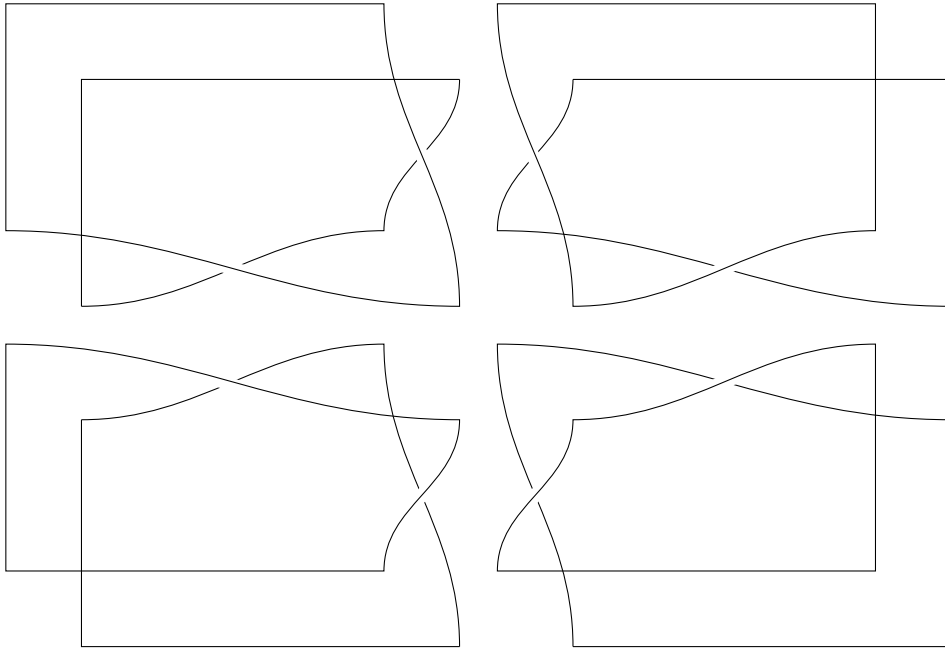

by the following, and vice versa.



**Notation 4.1.2.4.** Let

$$F(\mathcal{S}) \xrightarrow{\text{Bubble}_{\text{two}}(\text{one half})} \text{2-Braids}$$

be the functor of strict monoidal cubical 2-categories to which, by means of the universal property of  $F(\mathcal{S})$ , the functor

$$\mathcal{S} \longrightarrow \text{2-Braids}$$

corresponding to the 2-arrow of 2-Braids obtained by pasting together the following 2-arrows of 2-Braids gives rise.

$$\begin{array}{ccccc}
 2 & \xrightarrow{id(2)} & 2 & \xrightarrow{id(2)} & 2 \\
 \downarrow id(2) & & \downarrow \sigma^{-1} & & \downarrow id(2) \\
 & \sigma_{LURU} & & \sigma_{LOLU} & \\
 2 & \xrightarrow{\sigma^{-1}} & 2 & \xrightarrow{\sigma} & 2 \\
 \downarrow id(2) & & \downarrow \sigma & & \downarrow id(2) \\
 & \sigma_{UURO} & & \sigma_{UOLO} & \\
 2 & \xrightarrow{id(2)} & 2 & \xrightarrow{id(2)} & 2
 \end{array}$$

**Notation 4.1.2.5.** Let

$$\mathbf{F}(\mathcal{S}) \xrightarrow{\text{Bubble}_{\text{two}}(\text{other half})} \text{2-Braids}$$

be the functor of strict monoidal cubical 2-categories to which, by means of the universal property of  $\mathbf{F}(\mathcal{S})$ , the functor

$$\mathcal{S} \longrightarrow \text{2-Braids}$$

corresponding to the 2-arrow

$$\begin{array}{ccc}
 2 & \xrightarrow{id(2)} & 2 \\
 \downarrow id(2) & id(id(2)) & \downarrow id(2) \\
 2 & \xrightarrow{id(2)} & 2
 \end{array}$$

of 2-Braids gives rise.

**Remark 4.1.2.6.** The 2-arrows  $\text{Bubble}_{\text{two}}(\text{one half})$  and  $\text{Bubble}_{\text{two}}(\text{other half})$  of 2-Braids express algebraically the two halves of the Roseman move known as the bubble move, which allows us to replace

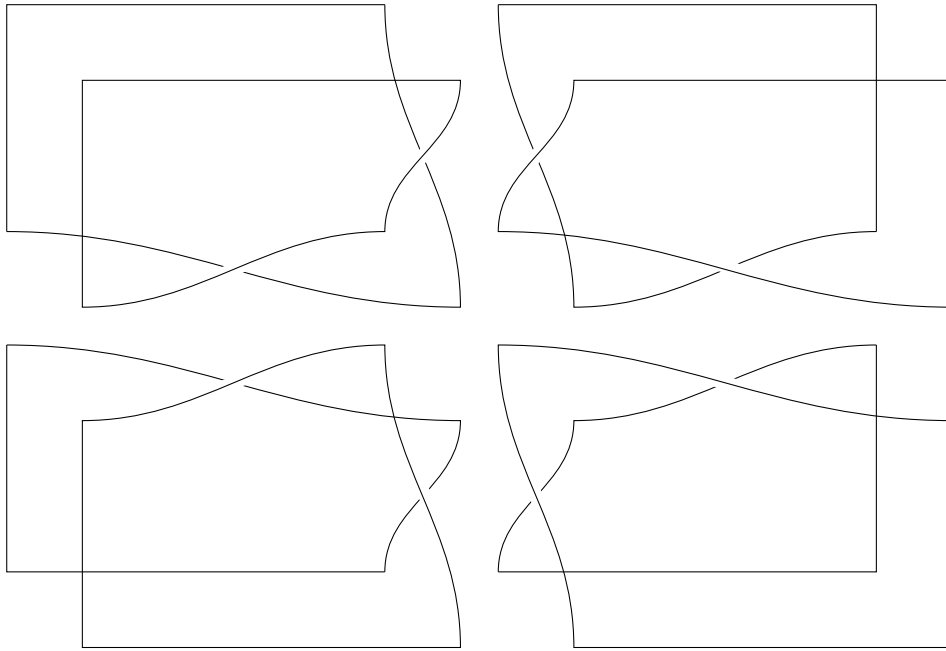

by the following, and vice versa.



**Notation 4.1.2.7.** Let

$$F(\mathcal{S}) \xrightarrow{\text{Saddle}_{\text{one}}(\text{other half})} \text{2-Braids}$$

be the functor of strict monoidal cubical 2-categories to which, by means of the universal property of  $F(\mathcal{S})$ , the functor

$$\mathcal{S} \longrightarrow \text{2-Braids}$$

corresponding to the 2-arrow

$$\begin{array}{ccc}
 2 & \xrightarrow{\sigma^{-1} \circ \sigma} & 2 \\
 \text{id}(2) \downarrow & \text{id}_{\text{ver}}(\sigma^{-1} \circ \sigma) & \downarrow \text{id}(2) \\
 2 & \xrightarrow{\sigma^{-1} \circ \sigma} & 2
 \end{array}$$

of 2-Braids gives rise.

**Remark 4.1.2.8.** The 2-arrows  $\text{Saddle}_{\text{one}}$  (one half) and  $\text{Saddle}_{\text{one}}$  (other half) of 2-Braids express algebraically the two halves of the Roseman move known as the saddle move, which allows us to replace

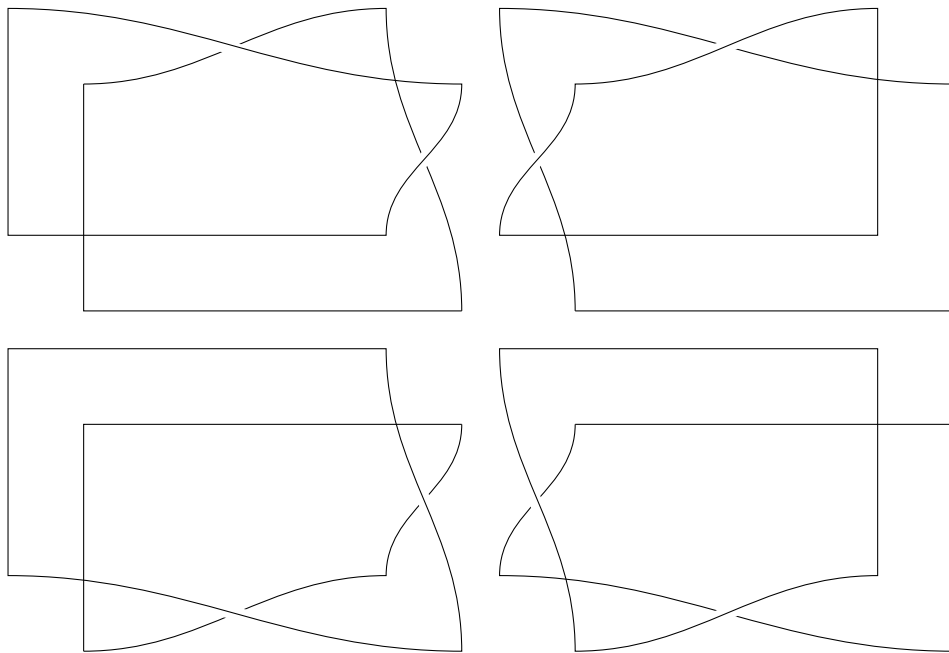

by the following, and vice versa.

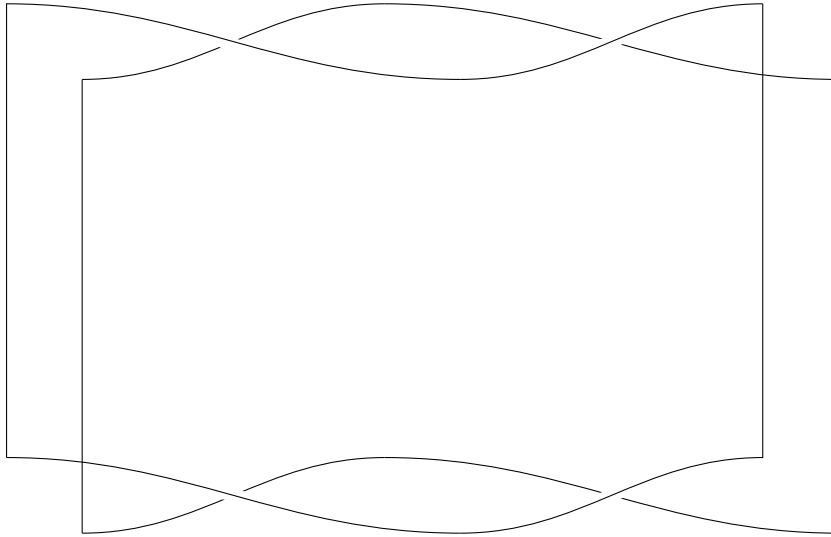

**Notation 4.1.2.9.** Let

$$F(\mathcal{S}) \xrightarrow{\text{Saddle}_{\text{two}}(\text{one half})} \mathbf{2}\text{-Braids}$$

be the functor of strict monoidal cubical 2-categories to which, by means of the universal property of  $F(\mathcal{S})$ , the functor

$$\mathcal{S} \longrightarrow \mathbf{2}\text{-Braids}$$

corresponding to the 2-arrow of  $\mathbf{2}\text{-Braids}$  obtained by pasting together the following 2-arrows of  $\mathbf{2}\text{-Braids}$  gives rise.

$$\begin{array}{ccccc}
 2 & \xrightarrow{\sigma^{-1}} & 2 & \xrightarrow{\sigma} & 2 \\
 \downarrow id(2) & & \downarrow \sigma & & \downarrow id(2) \\
 & \sigma_{\text{UURO}} & & \sigma_{\text{UOLO}} & \\
 2 & \xrightarrow{id(2)} & 2 & \xrightarrow{id(2)} & 2 \\
 \downarrow id(2) & & \downarrow \sigma^{-1} & & \downarrow id(2) \\
 & \sigma_{\text{LURU}} & & \sigma_{\text{LOLU}} & \\
 2 & \xrightarrow{\sigma^{-1}} & 2 & \xrightarrow{\sigma} & 2
 \end{array}$$

**Notation 4.1.2.10.** Let

$$F(\mathcal{S}) \xrightarrow{\text{Saddle}_{\text{two}}(\text{other half})} \text{2-Braids}$$

be the functor of strict monoidal cubical 2-categories to which, by means of the universal property of  $F(\mathcal{S})$ , the functor

$$\mathcal{S} \longrightarrow \text{2-Braids}$$

corresponding to the 2-arrow

$$\begin{array}{ccc}
 2 & \xrightarrow{\sigma \circ \sigma^{-1}} & 2 \\
 \text{id}(2) \downarrow & \text{id}_{\text{ver}}(\sigma \circ \sigma^{-1}) & \downarrow \text{id}(2) \\
 2 & \xrightarrow{\sigma \circ \sigma^{-1}} & 2
 \end{array}$$

of 2-Braids gives rise.

**Remark 4.1.2.11.** The 2-arrows  $\text{Saddle}_{\text{two}}(\text{one half})$  and  $\text{Saddle}_{\text{two}}(\text{other half})$  of 2-Braids express algebraically the two halves of the Roseman move known as the saddle move, which allows us to replace

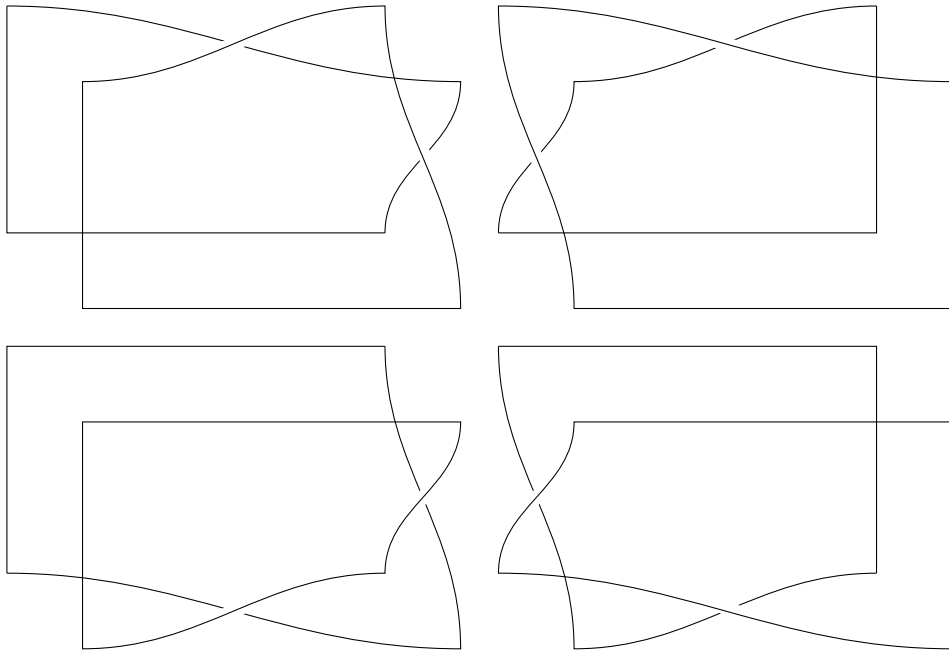

by the following, and vice versa.

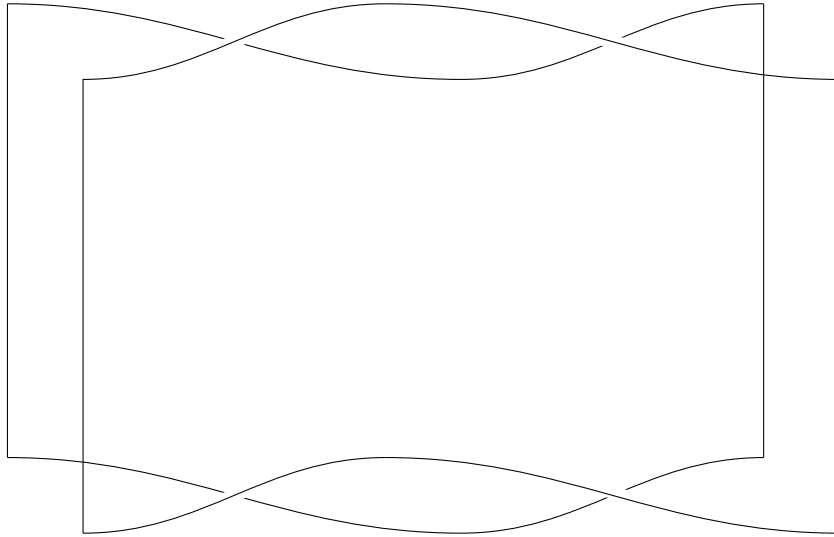

**Notation 4.1.2.12.** Let

$$F(\mathcal{S}) \xrightarrow{\text{Saddle}_{\text{three}}(\text{one half})} \mathbf{2}\text{-Braids}$$

be the functor of strict monoidal cubical 2-categories to which, by means of the universal property of  $F(\mathcal{S})$ , the functor

$$\mathcal{S} \longrightarrow \mathbf{2}\text{-Braids}$$

corresponding to the 2-arrow of  $\mathbf{2}\text{-Braids}$  obtained by pasting together the following 2-arrows of  $\mathbf{2}\text{-Braids}$  gives rise.

$$\begin{array}{ccccc}
 2 & \xrightarrow{id(2)} & 2 & \xrightarrow{id(2)} & 2 \\
 \sigma \downarrow & \sigma_{\text{LULO}} & id(2) \downarrow & \sigma_{\text{LORO}} & \sigma \downarrow \\
 2 & \xrightarrow{\sigma^{-1}} & 2 & \xrightarrow{\sigma} & 2 \\
 \sigma^{-1} \downarrow & \sigma_{\text{UULU}} & id(2) \downarrow & \sigma_{\text{UORU}} & \sigma^{-1} \downarrow \\
 2 & \xrightarrow{id(2)} & 2 & \xrightarrow{id(2)} & 2
 \end{array}$$



**Notation 4.1.2.13.** Let

$$F(\mathcal{S}) \xrightarrow{\text{Saddle}_{\text{three}}(\text{other half})} \text{2-Braids}$$

be the functor of strict monoidal cubical 2-categories to which, by means of the universal property of  $F(\mathcal{S})$ , the functor

$$\mathcal{S} \longrightarrow \text{2-Braids}$$

corresponding to the 2-arrow

$$\begin{array}{ccc} 2 & \xrightarrow{id(2)} & 2 \\ \sigma^{-1} \circ \sigma \downarrow & id_{\text{hor}}(\sigma^{-1} \circ \sigma) & \downarrow \sigma^{-1} \circ \sigma \\ 2 & \xrightarrow{id(2)} & 2 \end{array}$$

of 2-Braids gives rise.

**Remark 4.1.2.14.** The 2-arrows  $\text{Saddle}_{\text{three}}(\text{one half})$  and  $\text{Saddle}_{\text{three}}(\text{other half})$  of 2-Braids express algebraically the two halves of the Roseman move known as the saddle move, which allows us to replace

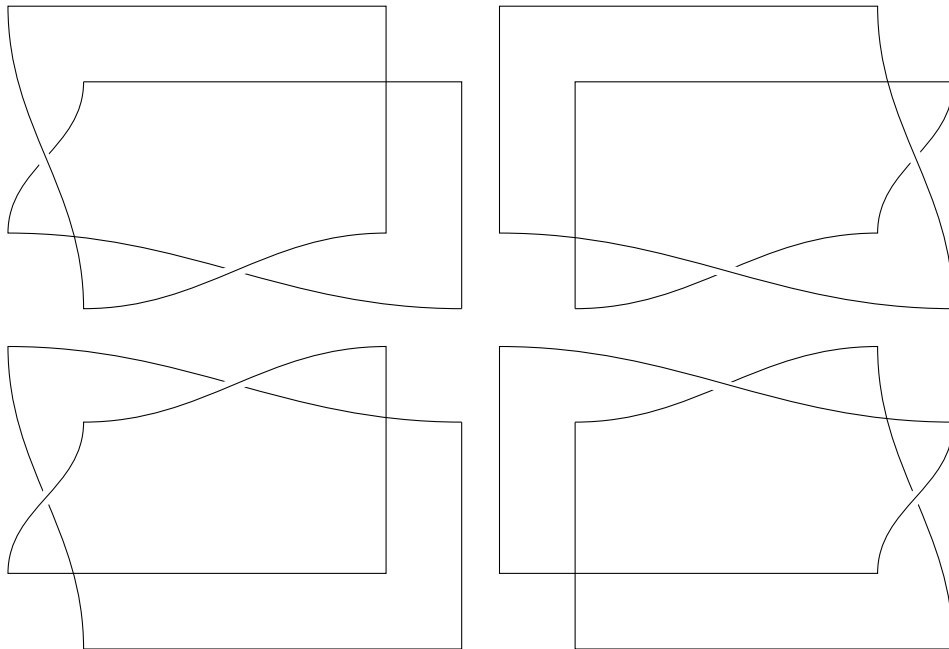

by the following, and vice versa.



**Notation 4.1.2.15.** Let

$$F(\mathcal{S}) \xrightarrow{\text{Saddle}_{\text{four}}(\text{one half})} \mathbf{2}\text{-Braids}$$

be the functor of strict monoidal cubical 2-categories to which, by means of the universal property of  $F(\mathcal{S})$ , the functor

$$\mathcal{S} \longrightarrow \mathbf{2}\text{-Braids}$$

corresponding to the 2-arrow of  $\mathbf{2}\text{-Braids}$  obtained by pasting together the following 2-arrows of  $\mathbf{2}\text{-Braids}$  gives rise.

$$\begin{array}{ccccc}
 2 & \xrightarrow{id(2)} & 2 & \xrightarrow{id(2)} & 2 \\
 \sigma^{-1} \downarrow & \sigma_{\text{LOLU}} & id(2) \downarrow & \sigma_{\text{LURU}} & \sigma^{-1} \downarrow \\
 2 & \xrightarrow{\sigma} & 2 & \xrightarrow{\sigma^{-1}} & 2 \\
 \sigma \downarrow & \sigma_{\text{UOLO}} & id(2) \downarrow & \sigma_{\text{UURO}} & \sigma \downarrow \\
 2 & \xrightarrow{id(2)} & 2 & \xrightarrow{id(2)} & 2
 \end{array}$$

**Notation 4.1.2.16.** Let

$$F(\mathcal{S}) \xrightarrow{\text{Saddle}_{\text{four}}(\text{other half})} \text{2-Braids}$$

be the functor of strict monoidal cubical 2-categories to which, by means of the universal property of  $F(\mathcal{S})$ , the functor

$$\mathcal{S} \longrightarrow \text{2-Braids}$$

corresponding to the 2-arrow

$$\begin{array}{ccc} 2 & \xrightarrow{id(2)} & 2 \\ \sigma \circ \sigma^{-1} \downarrow & id_{\text{hor}}(\sigma \circ \sigma^{-1}) & \downarrow \sigma \circ \sigma^{-1} \\ 2 & \xrightarrow{id(2)} & 2 \end{array}$$

of 2-Braids gives rise.

**Remark 4.1.2.17.** The 2-arrows  $\text{Saddle}_{\text{four}}(\text{one half})$  and  $\text{Saddle}_{\text{four}}(\text{other half})$  of 2-Braids express algebraically the two halves of the Roseman move known as the saddle move, which allows us to replace

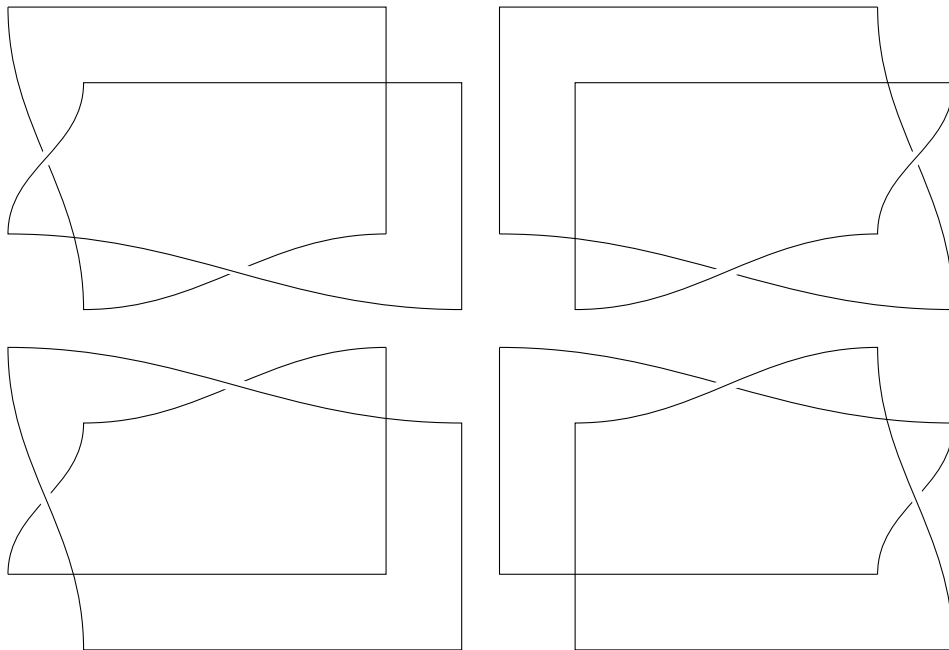

by the following, and vice versa.



**Notation 4.1.2.18.** Let

$$F(\mathcal{S}) \xrightarrow{\text{Triple}_{\text{one}}(\text{one half})} \mathbf{2}\text{-Braids}$$

be the functor of strict monoidal cubical 2-categories to which, by means of the universal property of  $F(\mathcal{S})$ , the functor

$$\mathcal{S} \longrightarrow \mathbf{2}\text{-Braids}$$

corresponding to the 2-arrow of  $\mathbf{2}\text{-Braids}$  obtained by pasting together the following 2-arrows of  $\mathbf{2}\text{-Braids}$  gives rise.

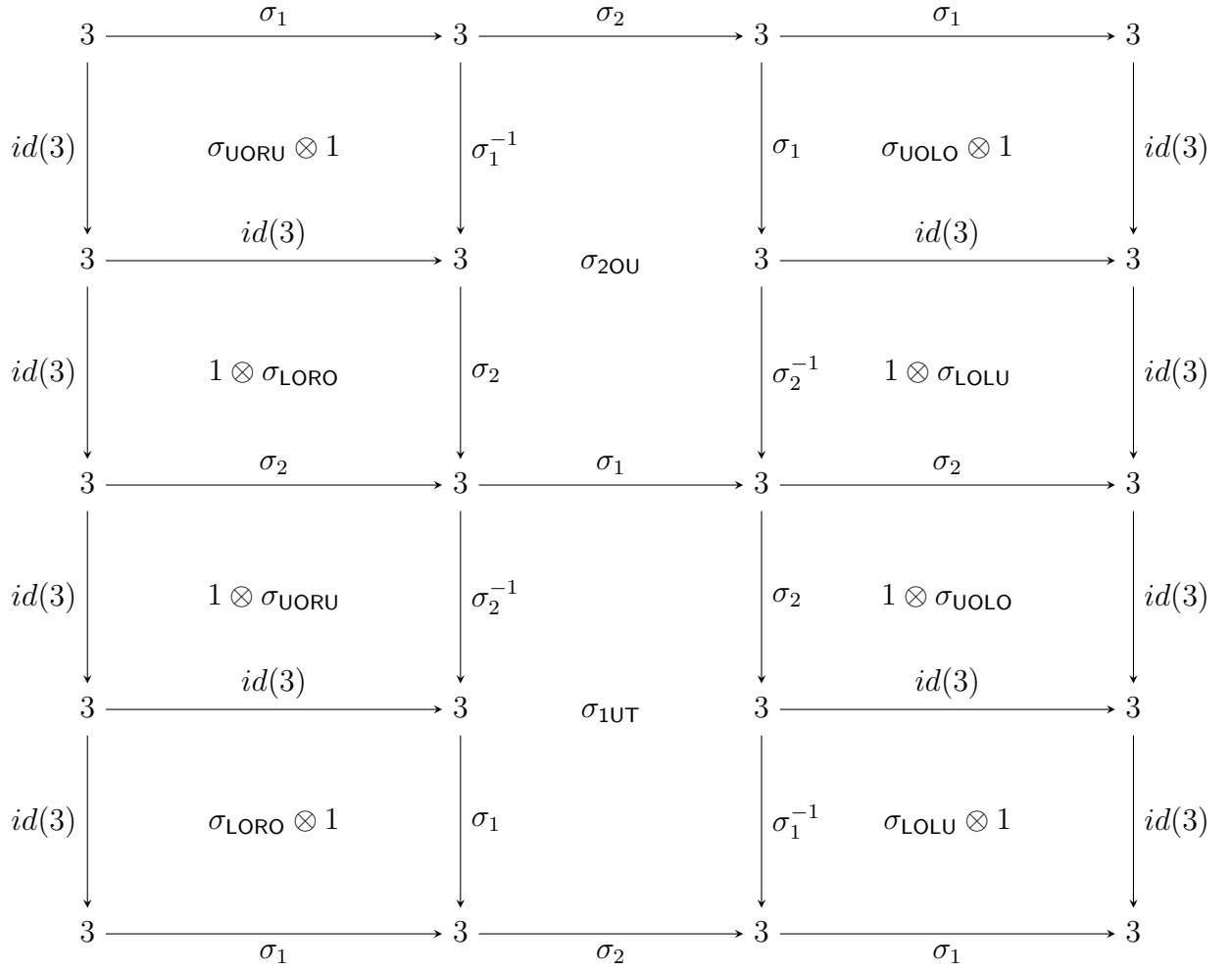

**Notation 4.1.2.19.** Let

$$F(\mathcal{S}) \xrightarrow{\text{Triple}_{\text{one}}(\text{other half})} \text{2-Braids}$$

be the functor of strict monoidal cubical 2-categories to which, by means of the universal property of  $F(\mathcal{S})$ , the functor

$$\mathcal{S} \longrightarrow \text{2-Braids}$$

corresponding to the 2-arrow of 2-Braids obtained by pasting together the following 2-arrows of 2-Braids gives rise.

$$\begin{array}{ccc}
 3 & \xrightarrow{\sigma_1 \circ \sigma_2 \circ \sigma_1} & 3 \\
 \downarrow id(3) & id_{\text{ver}}(\sigma_1 \circ \sigma_2 \circ \sigma_1) & \downarrow id(3) \\
 3 & \xrightarrow{\sigma_1 \circ \sigma_2 \circ \sigma_1} & 3
 \end{array}$$

**Remark 4.1.2.20.** The 2-arrows  $\text{Triple}_{\text{one}}$  (one half) and  $\text{Triple}_{\text{one}}$  (other half) of 2-Braids express algebraically the two halves of the Roseman move known as the triple move, which allows us to replace

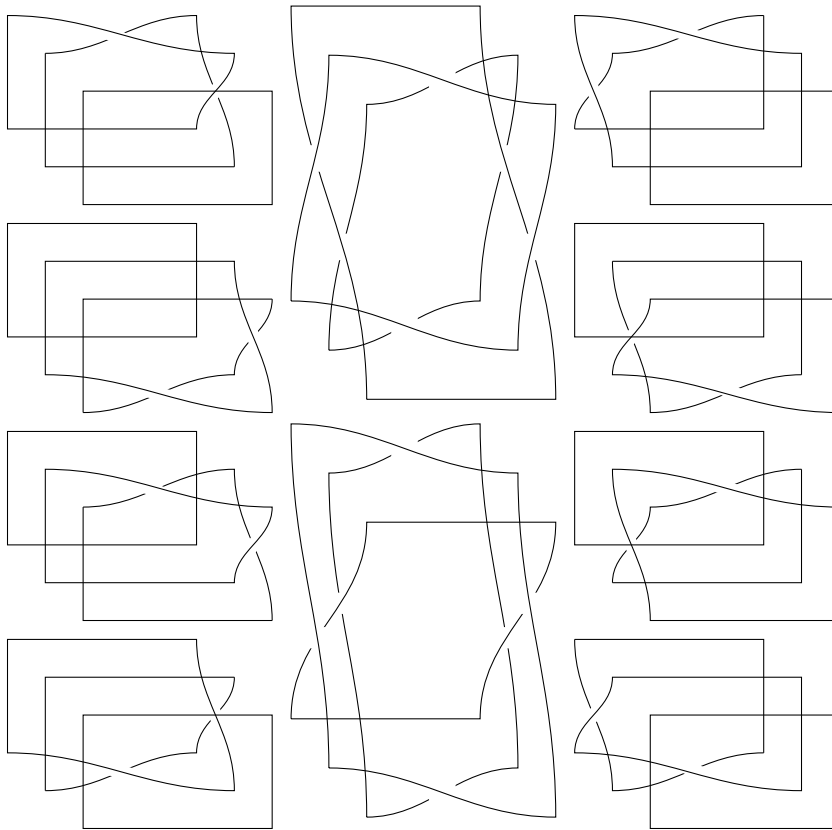

by the following, and vice versa.

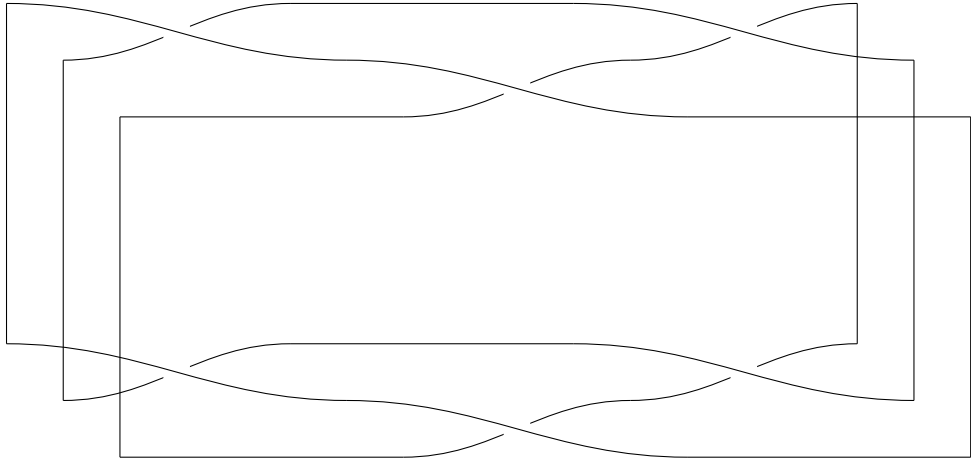

**Notation 4.1.2.21.** Let

$$F(\mathcal{S}) \xrightarrow{\text{Triple}_{\text{two}}(\text{one half})} \text{2-Braids}$$

be the functor of strict monoidal cubical 2-categories to which, by means of the universal property of  $F(\mathcal{S})$ , the functor

$$\mathcal{S} \longrightarrow \text{2-Braids}$$

corresponding to the 2-arrow of 2-Braids obtained by pasting together the following 2-arrows of 2-Braids gives rise.

$$\begin{array}{ccccccc}
3 & \xrightarrow{\sigma_1} & 3 & \xrightarrow{\sigma_2} & 3 & \xrightarrow{\sigma_1^{-1}} & 3 \\
\downarrow id(3) & & \downarrow \sigma_1^{-1} & & \downarrow \sigma_1^{-1} & & \downarrow id(3) \\
3 & \xrightarrow{id(3)} & 3 & \xrightarrow{\sigma_{2TU}} & 3 & \xrightarrow{id(3)} & 3 \\
\downarrow id(3) & & \downarrow \sigma_2^{-1} & & \downarrow \sigma_2^{-1} & & \downarrow id(3) \\
3 & \xrightarrow{\sigma_2^{-1}} & 3 & \xrightarrow{\sigma_1} & 3 & \xrightarrow{\sigma_2} & 3 \\
\downarrow id(3) & & \downarrow \sigma_2 & & \downarrow \sigma_2 & & \downarrow id(3) \\
3 & \xrightarrow{id(3)} & 3 & \xrightarrow{\sigma_{1UO}} & 3 & \xrightarrow{id(3)} & 3 \\
\downarrow id(3) & & \downarrow \sigma_1 & & \downarrow \sigma_1 & & \downarrow id(3) \\
3 & \xrightarrow{\sigma_1} & 3 & \xrightarrow{\sigma_2} & 3 & \xrightarrow{\sigma_1^{-1}} & 3
\end{array}$$

**Notation 4.1.2.22.** Let

$$F(\mathcal{S}) \xrightarrow{\text{Triple}_{\text{two}}(\text{other half})} \text{2-Braids}$$

be the functor of strict monoidal cubical 2-categories to which, by means of the universal property of  $F(\mathcal{S})$ , the functor

$$\mathcal{S} \longrightarrow \text{2-Braids}$$

corresponding to the 2-arrow of 2-Braids obtained by pasting together the following 2-arrows of 2-Braids gives rise.



$$\begin{array}{ccc}
 3 & \xrightarrow{\sigma_1^{-1} \circ \sigma_2 \circ \sigma_1} & 3 \\
 \downarrow id(3) & \text{\scriptsize } id_{\text{ver}}(\sigma_1^{-1} \circ \sigma_2 \circ \sigma_1) & \downarrow id(3) \\
 3 & \xrightarrow{\sigma_1^{-1} \circ \sigma_2 \circ \sigma_1} & 3
 \end{array}$$

**Remark 4.1.2.23.** The 2-arrows  $\text{Triple}_{\text{two}}$ (one half) and  $\text{Triple}_{\text{two}}$ (other half) of 2-Braids express algebraically the two halves of the Roseman move known as the triple move, which allows us to replace

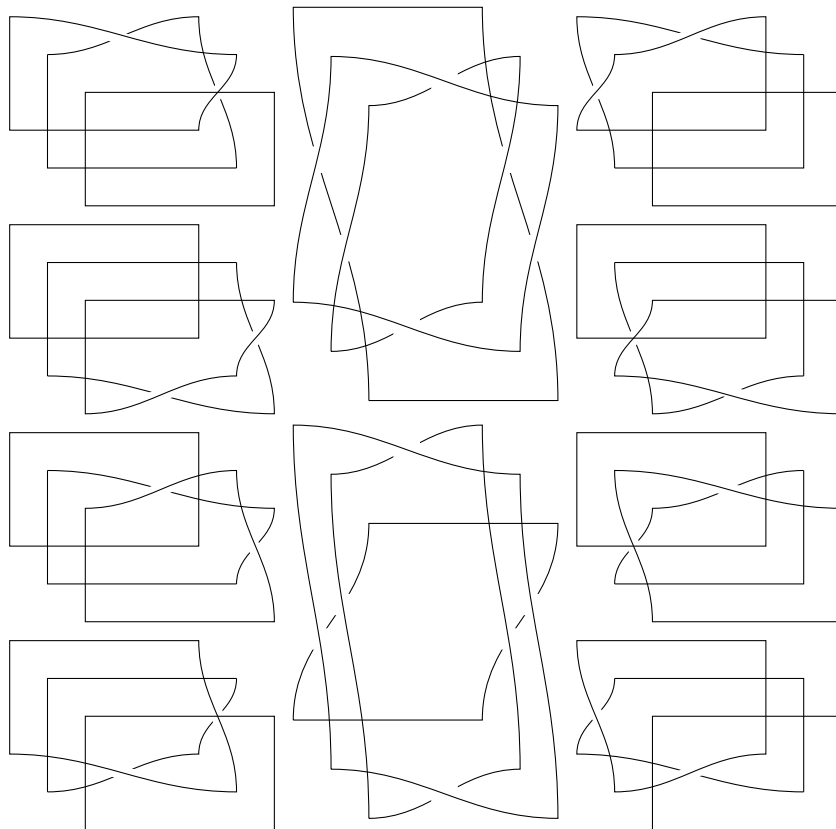

by the following, and vice versa.

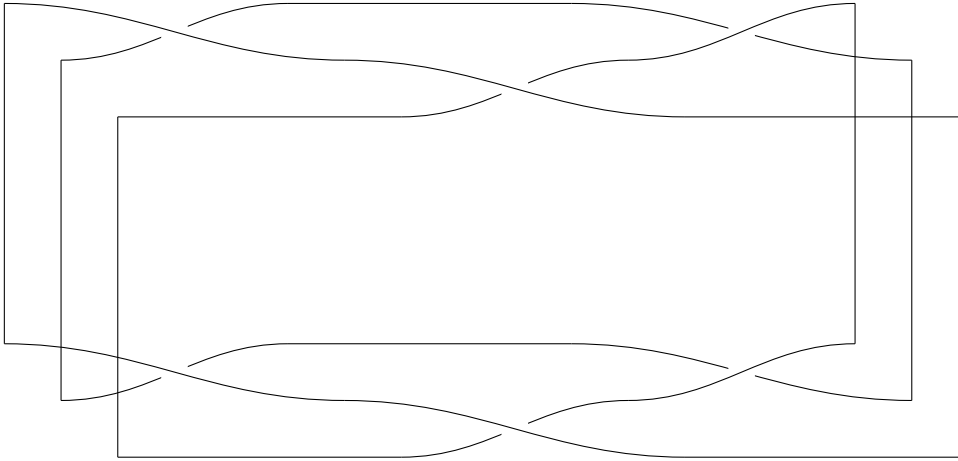

**Notation 4.1.2.24.** Let

$$F(\mathcal{S}) \xrightarrow{\text{Triple}_{\text{three}}(\text{one half})} \text{2-Braids}$$

be the functor of strict monoidal cubical 2-categories to which, by means of the universal property of  $F(\mathcal{S})$ , the functor

$$\mathcal{S} \longrightarrow \text{2-Braids}$$

corresponding to the 2-arrow of **2-Braids** obtained by pasting together the following 2-arrows of **2-Braids** gives rise.

$$\begin{array}{ccccccc}
3 & \xrightarrow{\sigma_1^{-1}} & 3 & \xrightarrow{\sigma_2} & 3 & \xrightarrow{\sigma_1} & 3 \\
\downarrow id(3) & & \downarrow \sigma_1 & & \downarrow \sigma_1 & & \downarrow id(3) \\
& \sigma_{UURO} \otimes 1 & & & \sigma_{UOLO} \otimes 1 & & \\
3 & \xrightarrow{id(3)} & 3 & \xrightarrow{\sigma_{2UO}} & 3 & \xrightarrow{id(3)} & 3 \\
\downarrow id(3) & & \downarrow \sigma_2 & & \downarrow \sigma_2 & & \downarrow id(3) \\
& 1 \otimes \sigma_{LORO} & & & 1 \otimes \sigma_{LULO} & & \\
3 & \xrightarrow{\sigma_2} & 3 & \xrightarrow{\sigma_1} & 3 & \xrightarrow{\sigma_2^{-1}} & 3 \\
\downarrow id(3) & & \downarrow \sigma_2^{-1} & & \downarrow \sigma_2^{-1} & & \downarrow id(3) \\
& 1 \otimes \sigma_{UORU} & & & 1 \otimes \sigma_{UULU} & & \\
3 & \xrightarrow{id(3)} & 3 & \xrightarrow{\sigma_{1OT}} & 3 & \xrightarrow{id(3)} & 3 \\
\downarrow id(3) & & \downarrow \sigma_1^{-1} & & \downarrow \sigma_1^{-1} & & \downarrow id(3) \\
& \sigma_{LURU} \otimes 1 & & & \sigma_{LOLU} \otimes 1 & & \\
3 & \xrightarrow{\sigma_1^{-1}} & 3 & \xrightarrow{\sigma_2} & 3 & \xrightarrow{\sigma_1} & 3
\end{array}$$

**Notation 4.1.2.25.** Let

$$F(\mathcal{S}) \xrightarrow{\text{Triple}_{\text{three}}(\text{other half})} \text{2-Braids}$$

be the functor of strict monoidal cubical 2-categories to which, by means of the universal property of  $F(\mathcal{S})$ , the functor

$$\mathcal{S} \longrightarrow \text{2-Braids}$$

corresponding to the 2-arrow of 2-Braids obtained by pasting together the following 2-arrows of 2-Braids gives rise.

$$\begin{array}{ccc}
 3 & \xrightarrow{\sigma_1 \circ \sigma_2 \circ \sigma_1^{-1}} & 3 \\
 \text{id}(3) \downarrow & \text{id}_{\text{ver}}(\sigma_1 \circ \sigma_2 \circ \sigma_1^{-1}) & \downarrow \text{id}(3) \\
 3 & \xrightarrow{\sigma_1 \circ \sigma_2 \circ \sigma_1^{-1}} & 3
 \end{array}$$

**Remark 4.1.2.26.** The 2-arrows  $\text{Triple}_{\text{three}}$ (one half) and  $\text{Triple}_{\text{three}}$ (other half) of 2-Braids express algebraically the two halves of the Roseman move known as the triple move, which allows us to replace

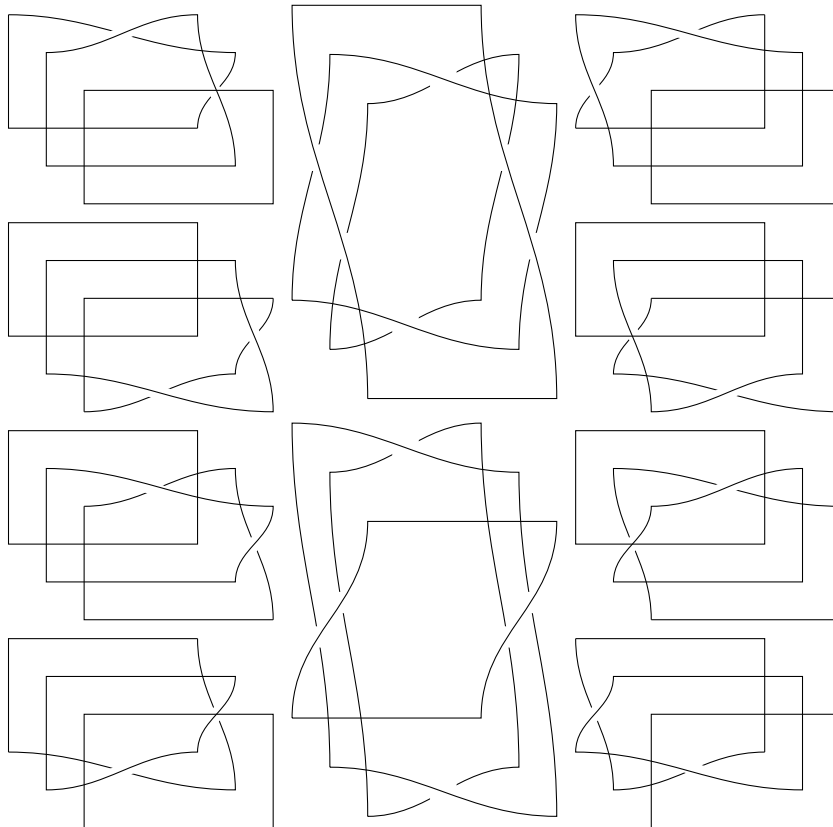

by the following, and vice versa.

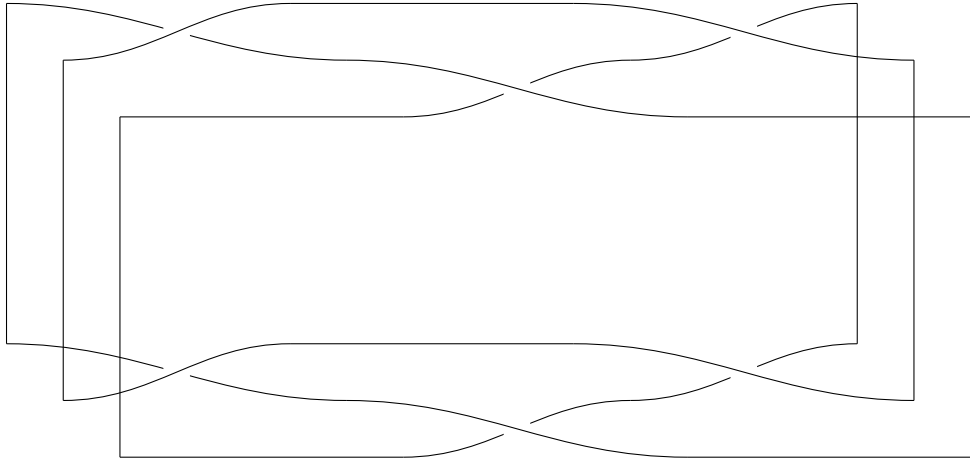

**Notation 4.1.2.27.** Let

$$F(\mathcal{S}) \xrightarrow{\text{Triple}_{\text{four}}(\text{one half})} \text{2-Braids}$$

be the functor of strict monoidal cubical 2-categories to which, by means of the universal property of  $F(\mathcal{S})$ , the functor

$$\mathcal{S} \longrightarrow \text{2-Braids}$$

corresponding to the 2-arrow of 2-Braids obtained by pasting together the following 2-arrows of 2-Braids gives rise.

$$\begin{array}{ccccccc}
3 & \xrightarrow{\sigma_1^{-1}} & 3 & \xrightarrow{\sigma_2^{-1}} & 3 & \xrightarrow{\sigma_1} & 3 \\
\downarrow id(3) & & \downarrow \sigma_1 & & \downarrow \sigma_1 & & \downarrow id(3) \\
3 & \xrightarrow{id(3)} & 3 & \xrightarrow{\sigma_{2UT}} & 3 & \xrightarrow{id(3)} & 3 \\
\downarrow id(3) & & \downarrow \sigma_2 & & \downarrow \sigma_2 & & \downarrow id(3) \\
3 & \xrightarrow{\sigma_2} & 3 & \xrightarrow{\sigma_1^{-1}} & 3 & \xrightarrow{\sigma_2^{-1}} & 3 \\
\downarrow id(3) & & \downarrow \sigma_2^{-1} & & \downarrow \sigma_2^{-1} & & \downarrow id(3) \\
3 & \xrightarrow{id(3)} & 3 & \xrightarrow{\sigma_{1TO}} & 3 & \xrightarrow{id(3)} & 3 \\
\downarrow id(3) & & \downarrow \sigma_1^{-1} & & \downarrow \sigma_1^{-1} & & \downarrow id(3) \\
3 & \xrightarrow{\sigma_1^{-1}} & 3 & \xrightarrow{\sigma_2^{-1}} & 3 & \xrightarrow{\sigma_1} & 3
\end{array}$$

**Notation 4.1.2.28.** Let

$$F(\mathcal{S}) \xrightarrow{\text{Triple}_{\text{four}}(\text{other half})} \text{2-Braids}$$

be the functor of strict monoidal cubical 2-categories to which, by means of the universal property of  $F(\mathcal{S})$ , the functor

$$\mathcal{S} \longrightarrow \text{2-Braids}$$

corresponding to the 2-arrow of 2-Braids obtained by pasting together the following 2-arrows of 2-Braids gives rise.

$$\begin{array}{ccc}
 3 & \xrightarrow{\sigma_1 \circ \sigma_2^{-1} \circ \sigma_1^{-1}} & 3 \\
 \downarrow id(3) & \text{\scriptsize } id_{\text{ver}}(\sigma_1 \circ \sigma_2^{-1} \circ \sigma_1^{-1}) & \downarrow id(3) \\
 3 & \xrightarrow{\sigma_1 \circ \sigma_2^{-1} \circ \sigma_1^{-1}} & 3
 \end{array}$$

**Remark 4.1.2.29.** The 2-arrows  $\text{Triple}_{\text{four}}(\text{one half})$  and  $\text{Triple}_{\text{four}}(\text{other half})$  of 2-Braids express algebraically the two halves of the Roseman move known as the triple move, which allows us to replace

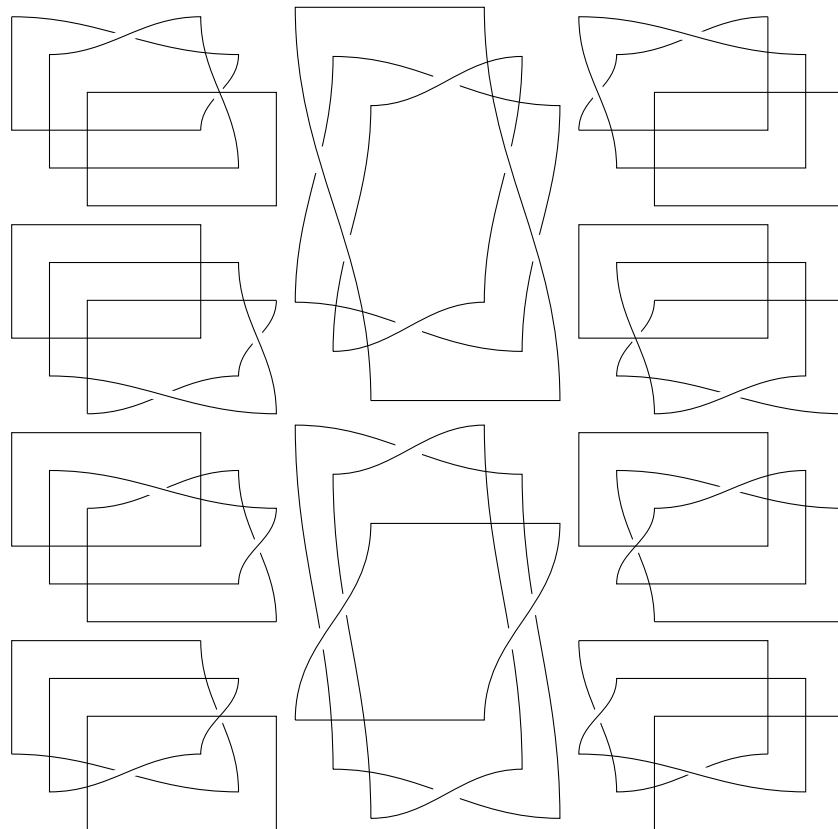

by the following, and vice versa.

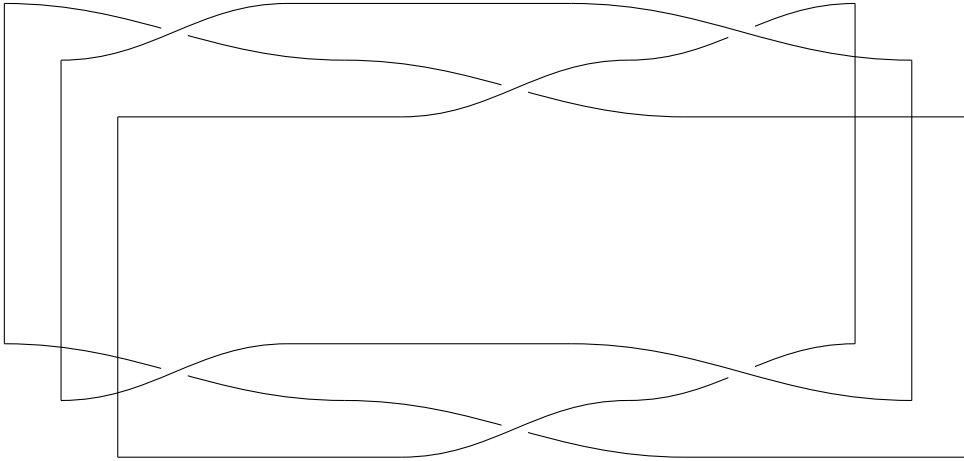

**Notation 4.1.2.30.** Let

$$F(\mathcal{S}) \xrightarrow{\text{Triple}_{\text{five}}(\text{one half})} \text{2-Braids}$$

be the functor of strict monoidal cubical 2-categories to which, by means of the universal property of  $F(\mathcal{S})$ , the functor

$$\mathcal{S} \longrightarrow \text{2-Braids}$$

corresponding to the 2-arrow of **2-Braids** obtained by pasting together the following 2-arrows of **2-Braids** gives rise.



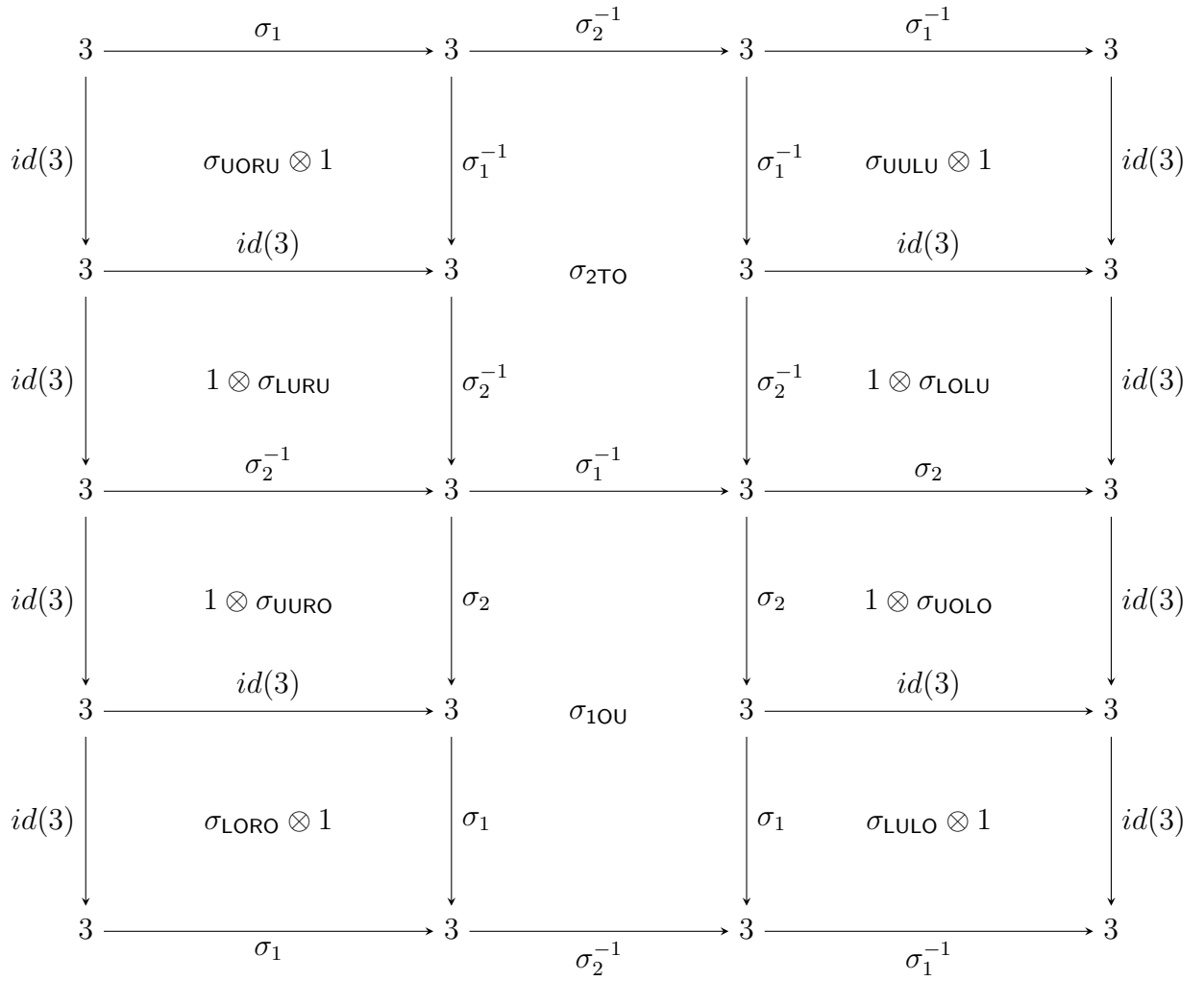

**Notation 4.1.2.31.** Let

$$F(\mathcal{S}) \xrightarrow{\text{Triple}_{\text{five}}(\text{other half})} \text{2-Braids}$$

be the functor of strict monoidal cubical 2-categories to which, by means of the universal property of  $F(\mathcal{S})$ , the functor

$$\mathcal{S} \longrightarrow \text{2-Braids}$$

corresponding to the 2-arrow of 2-Braids obtained by pasting together the following 2-arrows of 2-Braids gives rise.

$$\begin{array}{ccc}
 3 & \xrightarrow{\sigma_1^{-1} \circ \sigma_2^{-1} \circ \sigma_1} & 3 \\
 \downarrow id(3) & id_{\text{ver}}(\sigma_1^{-1} \circ \sigma_2^{-1} \circ \sigma_1) & \downarrow id(3) \\
 3 & \xrightarrow{\sigma_1^{-1} \circ \sigma_2^{-1} \circ \sigma_1} & 3
 \end{array}$$

**Remark 4.1.2.32.** The 2-arrows  $\text{Triple}_{\text{five}}(\text{one half})$  and  $\text{Triple}_{\text{five}}(\text{other half})$  of 2-Braids express algebraically the two halves of the Roseman move known as the triple move, which allows us to replace

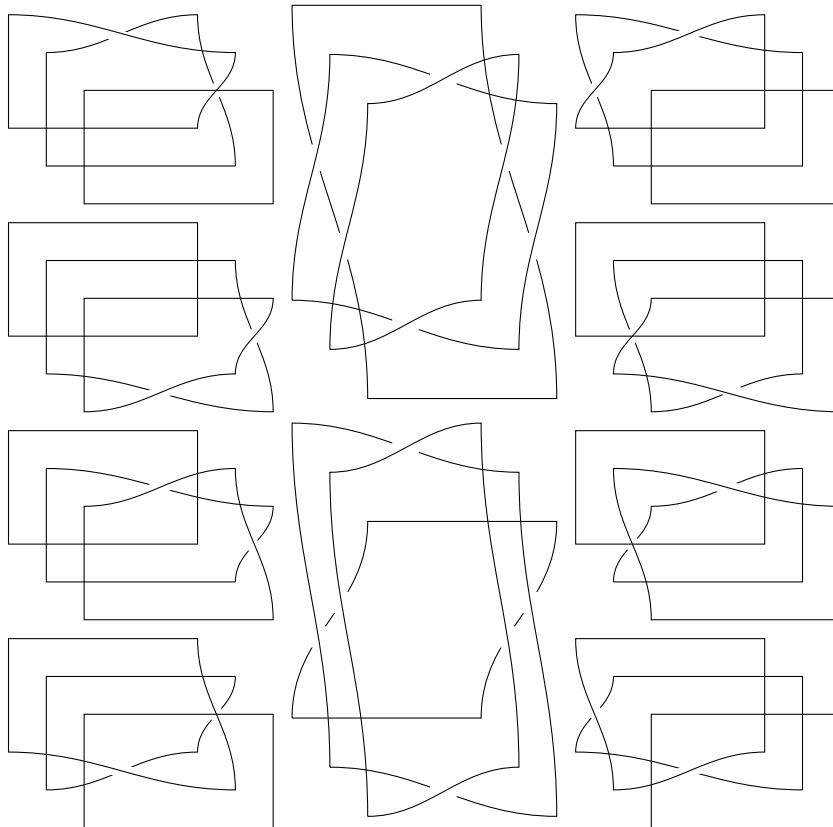

by the following, and vice versa.

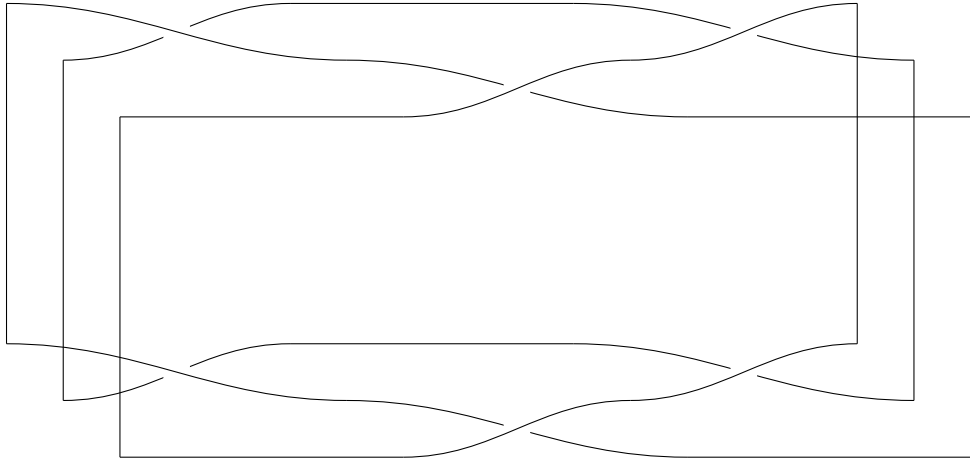

**Notation 4.1.2.33.** Let

$$F(\mathcal{S}) \xrightarrow{\text{Triple}_{\text{six}}(\text{one half})} \text{2-Braids}$$

be the functor of strict monoidal cubical 2-categories to which, by means of the universal property of  $F(\mathcal{S})$ , the functor

$$\mathcal{S} \longrightarrow \text{2-Braids}$$

corresponding to the 2-arrow of 2-Braids obtained by pasting together the following 2-arrows of 2-Braids gives rise.

$$\begin{array}{ccccccc}
3 & \xrightarrow{\sigma_1^{-1}} & 3 & \xrightarrow{\sigma_2^{-1}} & 3 & \xrightarrow{\sigma_1^{-1}} & 3 \\
\downarrow id(3) & & \downarrow \sigma_1 & & \downarrow \sigma_1^{-1} & & \downarrow id(3) \\
3 & \xrightarrow{id(3)} & 3 & \xrightarrow{\sigma_{20T}} & 3 & \xrightarrow{id(3)} & 3 \\
\downarrow id(3) & & \downarrow \sigma_2^{-1} & & \downarrow \sigma_2 & & \downarrow id(3) \\
3 & \xrightarrow{\sigma_2^{-1}} & 3 & \xrightarrow{\sigma_1^{-1}} & 3 & \xrightarrow{\sigma_2^{-1}} & 3 \\
\downarrow id(3) & & \downarrow \sigma_2 & & \downarrow \sigma_2^{-1} & & \downarrow id(3) \\
3 & \xrightarrow{id(3)} & 3 & \xrightarrow{\sigma_{1TU}} & 3 & \xrightarrow{id(3)} & 3 \\
\downarrow id(3) & & \downarrow \sigma_1^{-1} & & \downarrow \sigma_1 & & \downarrow id(3) \\
3 & \xrightarrow{\sigma_1^{-1}} & 3 & \xrightarrow{\sigma_2^{-1}} & 3 & \xrightarrow{\sigma_1^{-1}} & 3
\end{array}$$

**Notation 4.1.2.34.** Let

$$F(\mathcal{S}) \xrightarrow{\text{Triple}_{\text{six}}(\text{other half})} \text{2-Braids}$$

be the functor of strict monoidal cubical 2-categories to which, by means of the universal property of  $F(\mathcal{S})$ , the functor

$$\mathcal{S} \longrightarrow \text{2-Braids}$$

corresponding to the 2-arrow of 2-Braids obtained by pasting together the following 2-arrows of 2-Braids gives rise.

$$\begin{array}{ccc}
 3 & \xrightarrow{\sigma_1^{-1} \circ \sigma_2^{-1} \circ \sigma_1^{-1}} & 3 \\
 \text{id}(3) \downarrow & \text{id}_{\text{ver}}(\sigma_1^{-1} \circ \sigma_2^{-1} \circ \sigma_1^{-1}) & \downarrow \text{id}(3) \\
 3 & \xrightarrow{\sigma_1^{-1} \circ \sigma_2^{-1} \circ \sigma_1^{-1}} & 3
 \end{array}$$

**Remark 4.1.2.35.** The 2-arrows  $\text{Triple}_{\text{six}}$ (one half) and  $\text{Triple}_{\text{six}}$ (other half) of 2-Braids express algebraically the two halves of the Roseman move known as the tripe move, which allows us to replace

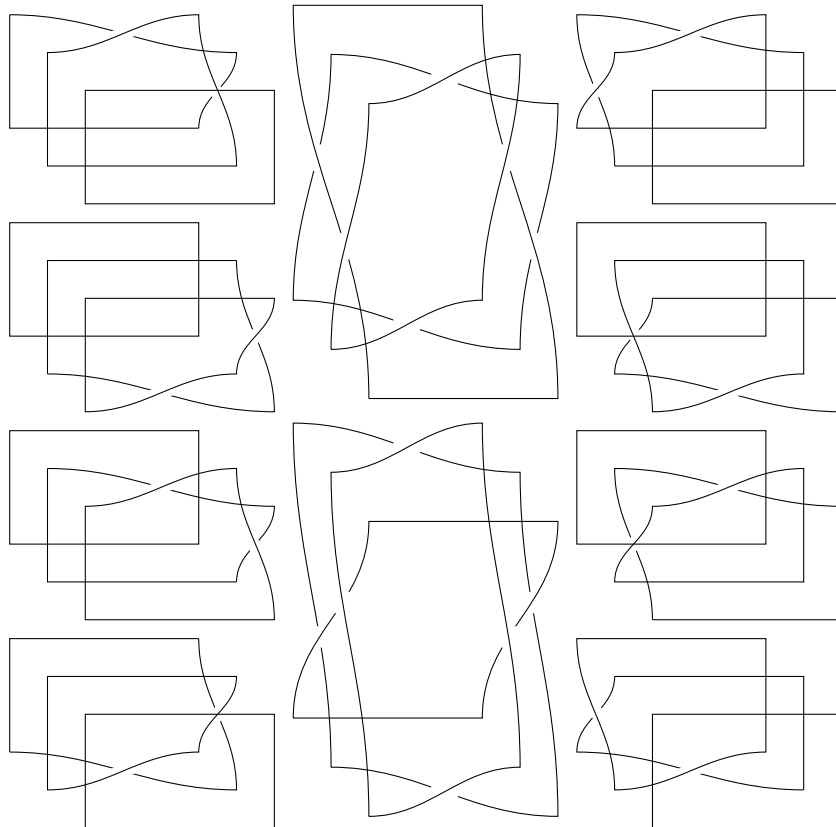

by the following, and vice versa.

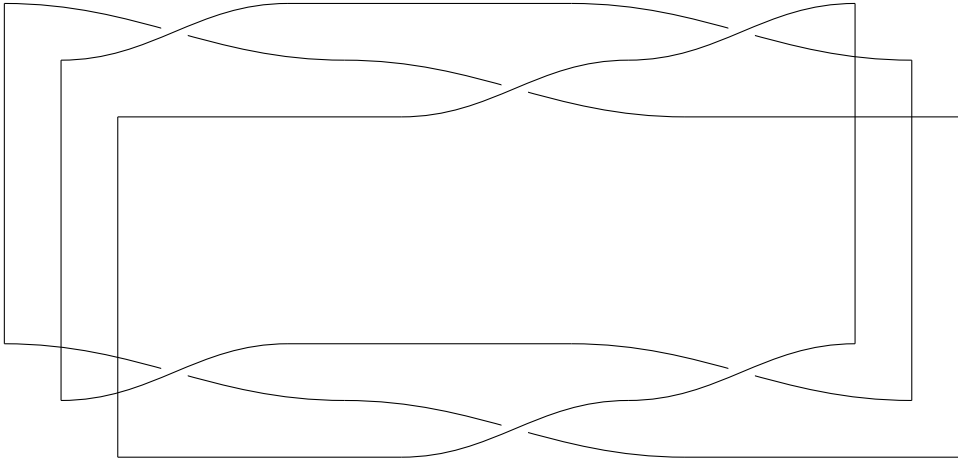

**Notation 4.1.2.36.** Let

$$F(\mathcal{S}) \xrightarrow{\text{Triple}_{\text{seven}}(\text{one half})} \text{2-Braids}$$

be the functor of strict monoidal cubical 2-categories to which, by means of the universal property of  $F(\mathcal{S})$ , the functor

$$\mathcal{S} \longrightarrow \text{2-Braids}$$

corresponding to the 2-arrow of 2-Braids obtained by pasting together the following 2-arrows of 2-Braids gives rise.

$$\begin{array}{ccccccc}
3 & \xrightarrow{\sigma_2} & 3 & \xrightarrow{\sigma_1} & 3 & \xrightarrow{\sigma_2} & 3 \\
\downarrow id(3) & & \downarrow \sigma_2^{-1} & & \downarrow \sigma_2 & & \downarrow id(3) \\
& 1 \otimes \sigma_{UORU} & & & 1 \otimes \sigma_{UOLO} & & \\
3 & \xrightarrow{id(3)} & 3 & \xrightarrow{\sigma_{1UT}} & 3 & \xrightarrow{id(3)} & 3 \\
\downarrow id(3) & & \downarrow \sigma_1 & & \downarrow \sigma_1^{-1} & & \downarrow id(3) \\
& \sigma_{LORO} \otimes 1 & & & \sigma_{LOLU} \otimes 1 & & \\
3 & \xrightarrow{\sigma_1} & 3 & \xrightarrow{\sigma_2} & 3 & \xrightarrow{\sigma_1} & 3 \\
\downarrow id(3) & & \downarrow \sigma_1^{-1} & & \downarrow \sigma_1 & & \downarrow id(3) \\
& \sigma_{UORU} \otimes 1 & & & \sigma_{UOLO} \otimes 1 & & \\
3 & \xrightarrow{id(3)} & 3 & \xrightarrow{\sigma_{2OU}} & 3 & \xrightarrow{id(3)} & 3 \\
\downarrow id(3) & & \downarrow \sigma_2 & & \downarrow \sigma_2^{-1} & & \downarrow id(3) \\
& 1 \otimes \sigma_{LORO} & & & 1 \otimes \sigma_{LOLU} & & \\
3 & \xrightarrow{\sigma_2} & 3 & \xrightarrow{\sigma_1} & 3 & \xrightarrow{\sigma_2} & 3
\end{array}$$

**Notation 4.1.2.37.** Let

$$F(\mathcal{S}) \xrightarrow{\text{Triple}_{\text{seven}}(\text{other half})} \text{2-Braids}$$

be the functor of strict monoidal cubical 2-categories to which, by means of the universal property of  $F(\mathcal{S})$ , the functor

$$\mathcal{S} \longrightarrow \text{2-Braids}$$

corresponding to the 2-arrow of 2-Braids obtained by pasting together the following 2-arrows of 2-Braids gives rise.

$$\begin{array}{ccc}
 3 & \xrightarrow{\sigma_2 \circ \sigma_1 \circ \sigma_2} & 3 \\
 \downarrow id(3) & id_{\text{ver}}(\sigma_2 \circ \sigma_1 \circ \sigma_2) & \downarrow id(3) \\
 3 & \xrightarrow{\sigma_2 \circ \sigma_1 \circ \sigma_2} & 3
 \end{array}$$

**Remark 4.1.2.38.** The 2-arrows  $\text{Triple}_{\text{seven}}(\text{one half})$  and  $\text{Triple}_{\text{seven}}(\text{other half})$  of 2-Braids express algebraically the two halves of the Roseman move known as the triple move, which allows us to replace

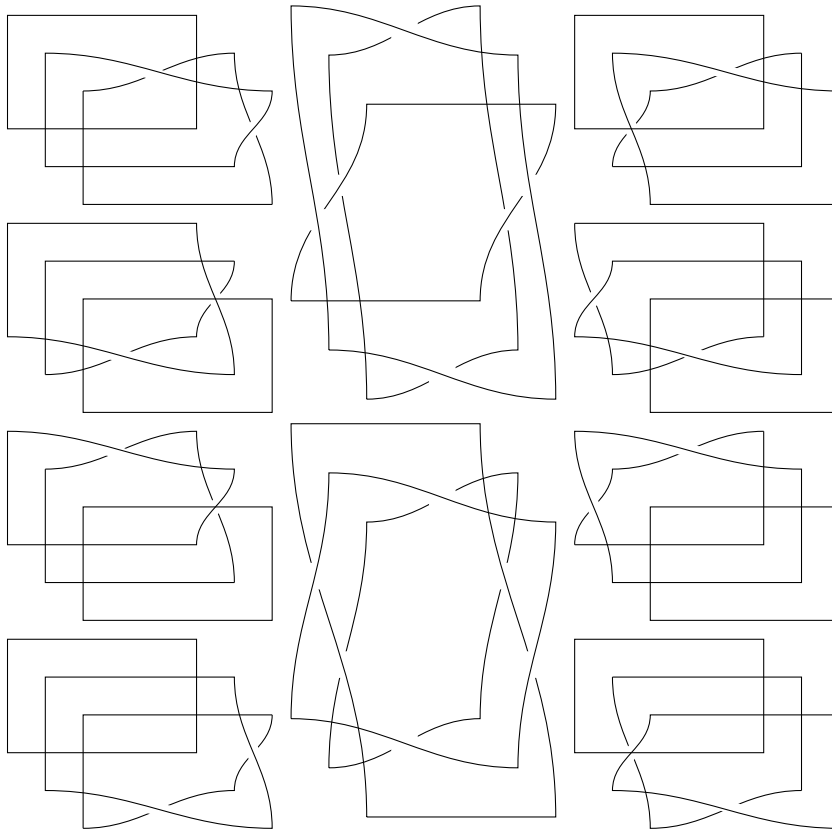

by the following, and vice versa.



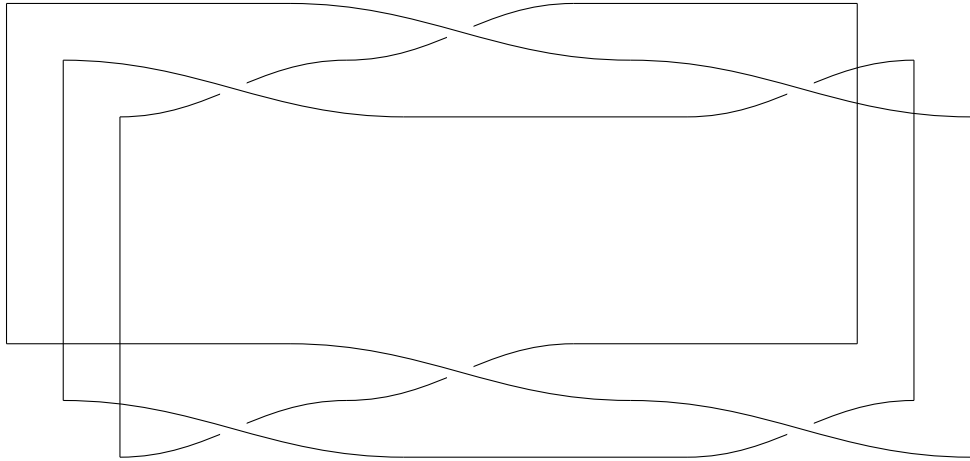

**Notation 4.1.2.39.** Let

$$F(\mathcal{S}) \xrightarrow{\text{Triple}_{\text{eight}}(\text{one half})} \text{2-Braids}$$

be the functor of strict monoidal cubical 2-categories to which, by means of the universal property of  $F(\mathcal{S})$ , the functor

$$\mathcal{S} \longrightarrow \text{2-Braids}$$

corresponding to the 2-arrow of 2-Braids obtained by pasting together the following 2-arrows of 2-Braids gives rise.

$$\begin{array}{ccccccc}
3 & \xrightarrow{\sigma_2^{-1}} & 3 & \xrightarrow{\sigma_1} & 3 & \xrightarrow{\sigma_2} & 3 \\
\downarrow id(3) & & \downarrow \sigma_2 & & \downarrow \sigma_2 & & \downarrow id(3) \\
& 1 \otimes \sigma_{UURO} & & & & 1 \otimes \sigma_{UOLO} & \\
3 & \xrightarrow{id(3)} & 3 & \xrightarrow{\sigma_{1UO}} & 3 & \xrightarrow{id(3)} & 3 \\
\downarrow id(3) & & \downarrow \sigma_1 & & \downarrow \sigma_1 & & \downarrow id(3) \\
& \sigma_{LORO} \otimes 1 & & & & \sigma_{LULO} \otimes 1 & \\
3 & \xrightarrow{\sigma_1} & 3 & \xrightarrow{\sigma_2} & 3 & \xrightarrow{\sigma_1^{-1}} & 3 \\
\downarrow id(3) & & \downarrow \sigma_1^{-1} & & \downarrow \sigma_1^{-1} & & \downarrow id(3) \\
& \sigma_{UORU} \otimes 1 & & & & \sigma_{UULU} \otimes 1 & \\
3 & \xrightarrow{id(3)} & 3 & \xrightarrow{\sigma_{2TU}} & 3 & \xrightarrow{id(3)} & 3 \\
\downarrow id(3) & & \downarrow \sigma_2^{-1} & & \downarrow \sigma_2^{-1} & & \downarrow id(3) \\
& 1 \otimes \sigma_{LURU} & & & & 1 \otimes \sigma_{LOLU} & \\
3 & \xrightarrow{\sigma_2^{-1}} & 3 & \xrightarrow{\sigma_1} & 3 & \xrightarrow{\sigma_2} & 3
\end{array}$$

**Notation 4.1.2.40.** Let

$$F(\mathcal{S}) \xrightarrow{\text{Triple}_{\text{eight}}(\text{other half})} \text{2-Braids}$$

be the functor of strict monoidal cubical 2-categories to which, by means of the universal property of  $F(\mathcal{S})$ , the functor

$$\mathcal{S} \longrightarrow \text{2-Braids}$$

corresponding to the 2-arrow of 2-Braids obtained by pasting together the following 2-arrows of 2-Braids gives rise.

$$\begin{array}{ccc}
 3 & \xrightarrow{\sigma_2 \circ \sigma_1 \circ \sigma_2^{-1}} & 3 \\
 \text{id}(3) \downarrow & \text{id}_{\text{ver}}(\sigma_2 \circ \sigma_1 \circ \sigma_2^{-1}) & \downarrow \text{id}(3) \\
 3 & \xrightarrow{\sigma_2 \circ \sigma_1 \circ \sigma_2^{-1}} & 3
 \end{array}$$

**Remark 4.1.2.41.** The 2-arrows  $\text{Triple}_{\text{eight}}(\text{one half})$  and  $\text{Triple}_{\text{eight}}(\text{other half})$  of 2-Braids express algebraically the two halves of the Roseman move known as the triple move, which allows us to replace

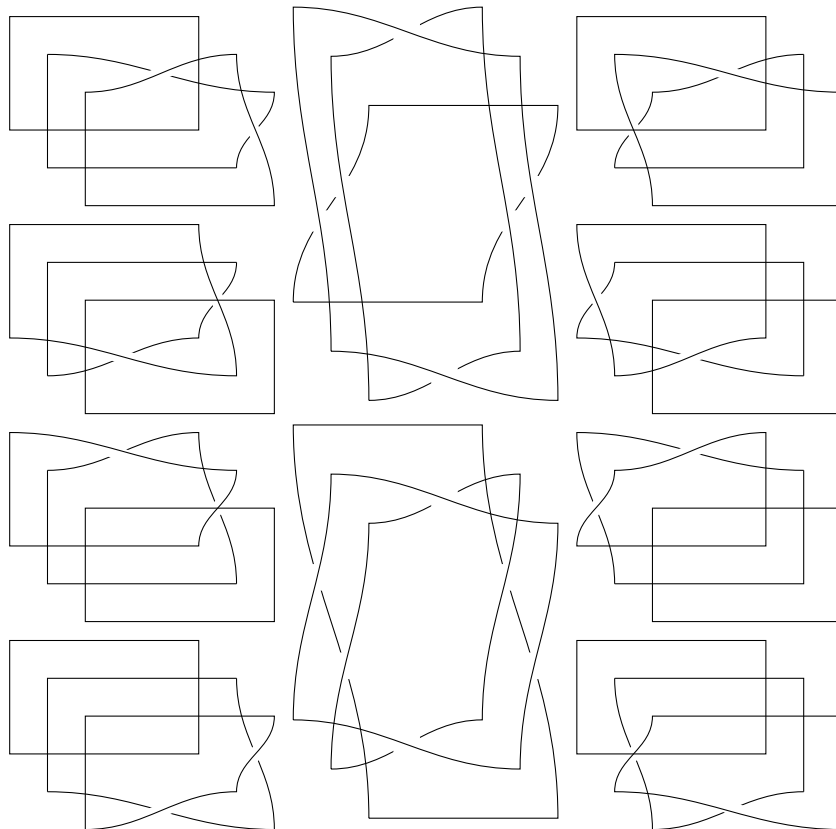

by the following, and vice versa.

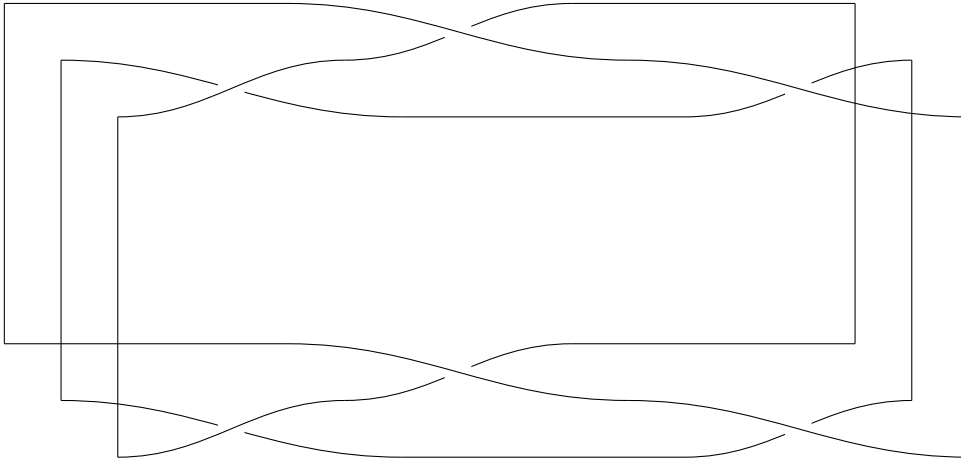

**Notation 4.1.2.42.** Let

$$F(\mathcal{S}) \xrightarrow{\text{Triple}_{\text{nine}}(\text{one half})} \text{2-Braids}$$

be the functor of strict monoidal cubical 2-categories to which, by means of the universal property of  $F(\mathcal{S})$ , the functor

$$\mathcal{S} \longrightarrow \text{2-Braids}$$

corresponding to the 2-arrow of **2-Braids** obtained by pasting together the following 2-arrows of **2-Braids** gives rise.

$$\begin{array}{ccccccc}
3 & \xrightarrow{\sigma_2} & 3 & \xrightarrow{\sigma_1} & 3 & \xrightarrow{\sigma_2^{-1}} & 3 \\
\downarrow id(3) & & \downarrow \sigma_2^{-1} & & \downarrow \sigma_2^{-1} & & \downarrow id(3) \\
& 1 \otimes \sigma_{UORU} & & & 1 \otimes \sigma_{UULU} & & \\
3 & \xrightarrow{id(3)} & 3 & \xrightarrow{\sigma_{10T}} & 3 & \xrightarrow{id(3)} & 3 \\
\downarrow id(3) & & \downarrow \sigma_1^{-1} & & \downarrow \sigma_1^{-1} & & \downarrow id(3) \\
& \sigma_{LURU} \otimes 1 & & & \sigma_{LOLU} \otimes 1 & & \\
3 & \xrightarrow{\sigma_1^{-1}} & 3 & \xrightarrow{\sigma_2} & 3 & \xrightarrow{\sigma_1} & 3 \\
\downarrow id(3) & & \downarrow \sigma_1 & & \downarrow \sigma_1 & & \downarrow id(3) \\
& \sigma_{UURO} \otimes 1 & & & \sigma_{UOLO} \otimes 1 & & \\
3 & \xrightarrow{id(3)} & 3 & \xrightarrow{\sigma_{2UO}} & 3 & \xrightarrow{id(3)} & 3 \\
\downarrow id(3) & & \downarrow \sigma_2 & & \downarrow \sigma_2 & & \downarrow id(3) \\
& 1 \otimes \sigma_{LORO} & & & 1 \otimes \sigma_{LULO} & & \\
3 & \xrightarrow{\sigma_2} & 3 & \xrightarrow{\sigma_1} & 3 & \xrightarrow{\sigma_2^{-1}} & 3
\end{array}$$

**Notation 4.1.2.43.** Let

$$F(\mathcal{S}) \xrightarrow{\text{Triple}_{\text{nine}}(\text{other half})} \text{2-Braids}$$

be the functor of strict monoidal cubical 2-categories to which, by means of the universal property of  $F(\mathcal{S})$ , the functor

$$\mathcal{S} \longrightarrow \text{2-Braids}$$

corresponding to the 2-arrow of 2-Braids obtained by pasting together the following 2-arrows of 2-Braids gives rise.

$$\begin{array}{ccc}
 3 & \xrightarrow{\sigma_2^{-1} \circ \sigma_1 \circ \sigma_2} & 3 \\
 \downarrow id(3) & \text{\scriptsize } id_{\text{ver}}(\sigma_2^{-1} \circ \sigma_1 \circ \sigma_2) & \downarrow id(3) \\
 3 & \xrightarrow{\sigma_2^{-1} \circ \sigma_1 \circ \sigma_2} & 3
 \end{array}$$

**Remark 4.1.2.44.** The 2-arrows  $\text{Triple}_{\text{nine}}$ (one half) and  $\text{Triple}_{\text{nine}}$ (other half) of 2-Braids express algebraically the two halves of the Roseman move known as the triple move, which allows us to replace

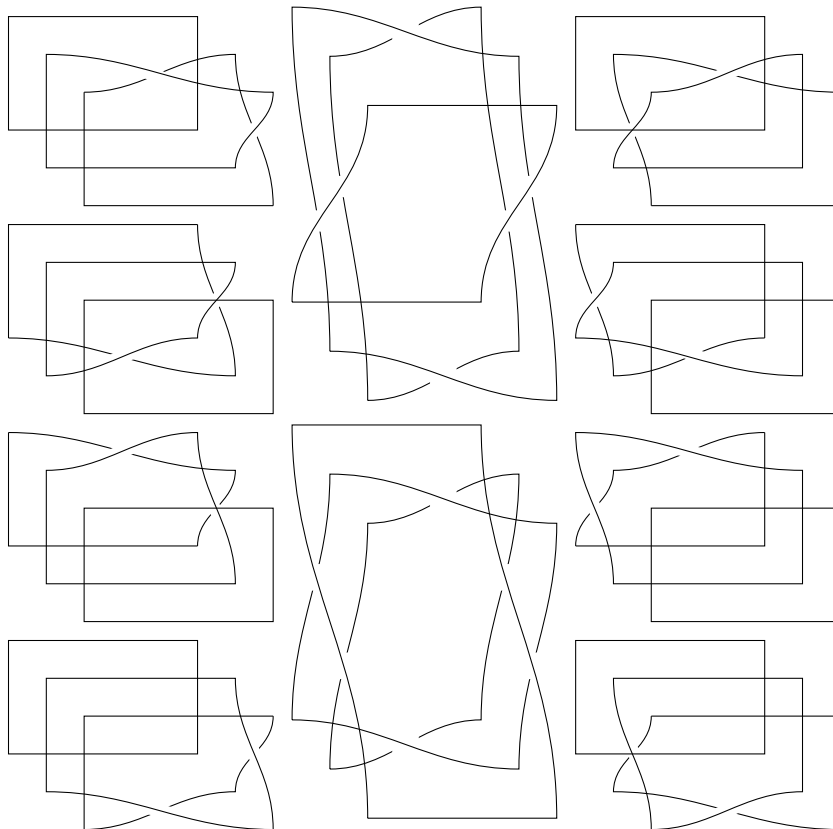

by the following, and vice versa.

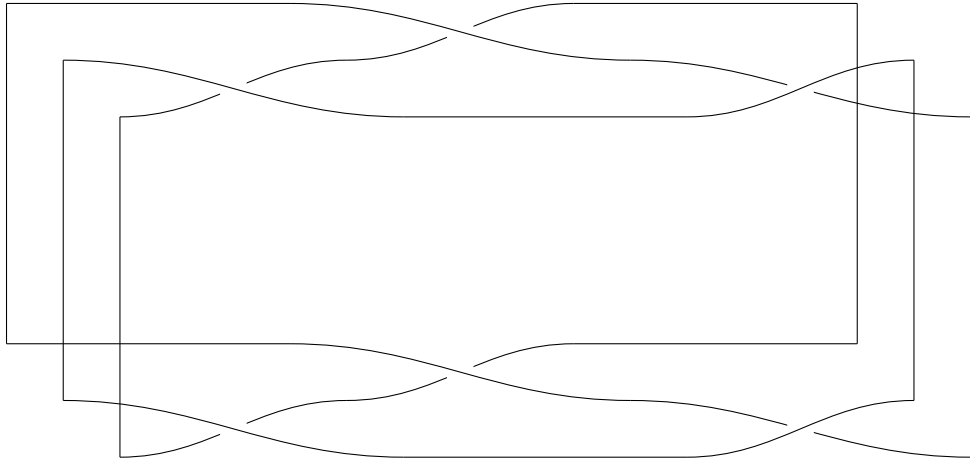

**Notation 4.1.2.45.** Let

$$F(\mathcal{S}) \xrightarrow{\text{Triple}_{\text{ten}}(\text{one half})} \text{2-Braids}$$

be the functor of strict monoidal cubical 2-categories to which, by means of the universal property of  $F(\mathcal{S})$ , the functor

$$\mathcal{S} \longrightarrow \text{2-Braids}$$

corresponding to the 2-arrow of 2-Braids obtained by pasting together the following 2-arrows of 2-Braids gives rise.

$$\begin{array}{ccccccc}
3 & \xrightarrow{\sigma_2} & 3 & \xrightarrow{\sigma_1^{-1}} & 3 & \xrightarrow{\sigma_2^{-1}} & 3 \\
\downarrow id(3) & & \downarrow \sigma_2^{-1} & & \downarrow \sigma_2^{-1} & & \downarrow id(3) \\
& 1 \otimes \sigma_{UORU} & & & 1 \otimes \sigma_{UULU} & & \\
3 & \xrightarrow{id(3)} & 3 & \xrightarrow{\sigma_{1TO}} & 3 & \xrightarrow{id(3)} & 3 \\
\downarrow id(3) & & \downarrow \sigma_1^{-1} & & \downarrow \sigma_1^{-1} & & \downarrow id(3) \\
& \sigma_{LURU} \otimes 1 & & & \sigma_{LOLU} \otimes 1 & & \\
3 & \xrightarrow{\sigma_1^{-1}} & 3 & \xrightarrow{\sigma_2^{-1}} & 3 & \xrightarrow{\sigma_1} & 3 \\
\downarrow id(3) & & \downarrow \sigma_1 & & \downarrow \sigma_1 & & \downarrow id(3) \\
& \sigma_{UURO} \otimes 1 & & & \sigma_{UOLO} \otimes 1 & & \\
3 & \xrightarrow{id(3)} & 3 & \xrightarrow{\sigma_{2UT}} & 3 & \xrightarrow{id(3)} & 3 \\
\downarrow id(3) & & \downarrow \sigma_2 & & \downarrow \sigma_2 & & \downarrow id(3) \\
& 1 \otimes \sigma_{LORO} & & & 1 \otimes \sigma_{LULO} & & \\
3 & \xrightarrow{\sigma_2} & 3 & \xrightarrow{\sigma_1^{-1}} & 3 & \xrightarrow{\sigma_2^{-1}} & 3
\end{array}$$

**Notation 4.1.2.46.** Let

$$F(\mathcal{S}) \xrightarrow{\text{Triple}_{\text{ten}}(\text{other half})} \text{2-Braids}$$

be the functor of strict monoidal cubical 2-categories to which, by means of the universal property of  $F(\mathcal{S})$ , the functor

$$\mathcal{S} \longrightarrow \text{2-Braids}$$

corresponding to the 2-arrow of 2-Braids obtained by pasting together the following 2-arrows of 2-Braids gives rise.



$$\begin{array}{ccc}
 3 & \xrightarrow{\sigma_2^{-1} \circ \sigma_1^{-1} \circ \sigma_2} & 3 \\
 \downarrow id(3) & \text{\scriptsize } id_{\text{ver}}(\sigma_2^{-1} \circ \sigma_1^{-1} \circ \sigma_2) & \downarrow id(3) \\
 3 & \xrightarrow{\sigma_2^{-1} \circ \sigma_1^{-1} \circ \sigma_2} & 3
 \end{array}$$

**Remark 4.1.2.47.** The 2-arrows  $\text{Triple}_{\text{ten}}$ (one half) and  $\text{Triple}_{\text{ten}}$ (other half) of 2-Braids express algebraically the two halves of the Roseman move known as the triple move, which allows us to replace

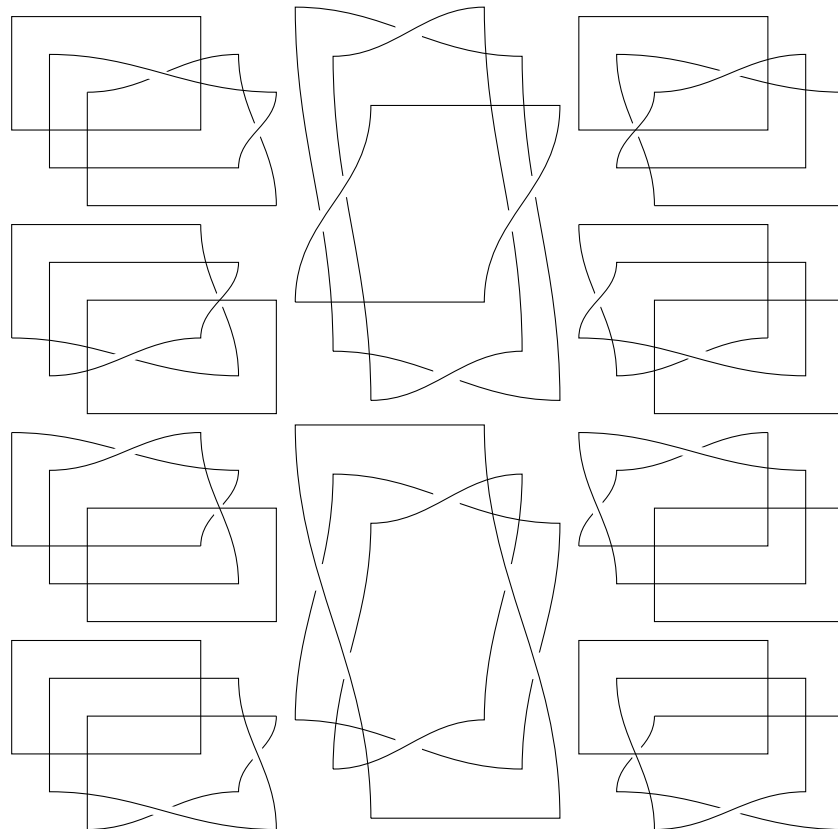

by the following, and vice versa.

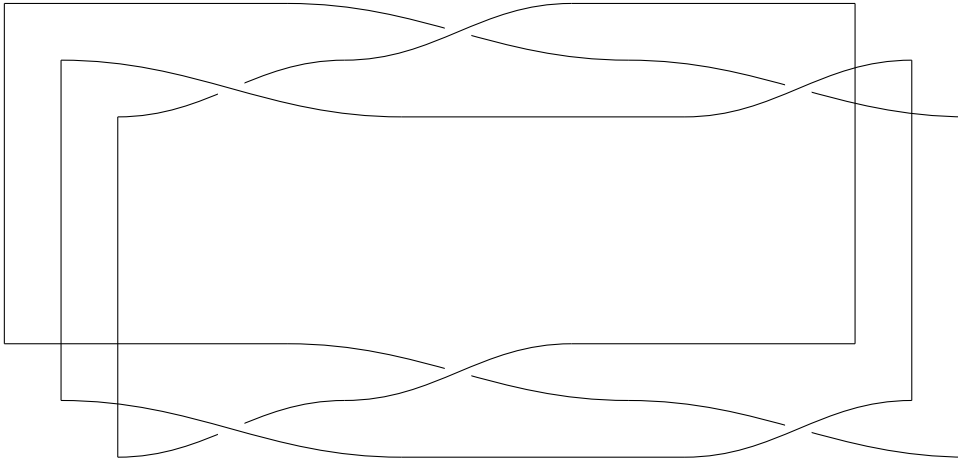

**Notation 4.1.2.48.** Let

$$F(\mathcal{S}) \xrightarrow{\text{Triple}_{\text{eleven}}(\text{one half})} \text{2-Braids}$$

be the functor of strict monoidal cubical 2-categories to which, by means of the universal property of  $F(\mathcal{S})$ , the functor

$$\mathcal{S} \longrightarrow \text{2-Braids}$$

corresponding to the 2-arrow of **2-Braids** obtained by pasting together the following 2-arrows of **2-Braids** gives rise.

$$\begin{array}{ccccccc}
3 & \xrightarrow{\sigma_2^{-1}} & 3 & \xrightarrow{\sigma_1^{-1}} & 3 & \xrightarrow{\sigma_2} & 3 \\
\downarrow id(3) & & \downarrow \sigma_2 & & \downarrow \sigma_2 & & \downarrow id(3) \\
& 1 \otimes \sigma_{UURO} & & & 1 \otimes \sigma_{UOLO} & & \\
3 & \xrightarrow{id(3)} & 3 & \xrightarrow{\sigma_{1OU}} & 3 & \xrightarrow{id(3)} & 3 \\
\downarrow id(3) & & \downarrow \sigma_1 & & \downarrow \sigma_1 & & \downarrow id(3) \\
& \sigma_{LORO} \otimes 1 & & & \sigma_{LULO} \otimes 1 & & \\
3 & \xrightarrow{\sigma_1} & 3 & \xrightarrow{\sigma_2^{-1}} & 3 & \xrightarrow{\sigma_1^{-1}} & 3 \\
\downarrow id(3) & & \downarrow \sigma_1^{-1} & & \downarrow \sigma_1^{-1} & & \downarrow id(3) \\
& \sigma_{UORU} \otimes 1 & & & \sigma_{UULU} \otimes 1 & & \\
3 & \xrightarrow{id(3)} & 3 & \xrightarrow{\sigma_{2TO}} & 3 & \xrightarrow{id(3)} & 3 \\
\downarrow id(3) & & \downarrow \sigma_2^{-1} & & \downarrow \sigma_2^{-1} & & \downarrow id(3) \\
& 1 \otimes \sigma_{LURU} & & & 1 \otimes \sigma_{LOLU} & & \\
3 & \xrightarrow{\sigma_2^{-1}} & 3 & \xrightarrow{\sigma_1^{-1}} & 3 & \xrightarrow{\sigma_2} & 3
\end{array}$$

**Notation 4.1.2.49.** Let

$$F(\mathcal{S}) \xrightarrow{\text{Triple}_{\text{eleven}}(\text{other half})} \text{2-Braids}$$

be the functor of strict monoidal cubical 2-categories to which, by means of the universal property of  $F(\mathcal{S})$ , the functor

$$\mathcal{S} \longrightarrow \text{2-Braids}$$

corresponding to the 2-arrow of 2-Braids obtained by pasting together the following 2-arrows of 2-Braids gives rise.

$$\begin{array}{ccc}
 3 & \xrightarrow{\sigma_2 \circ \sigma_1^{-1} \circ \sigma_2^{-1}} & 3 \\
 \downarrow id(3) & id_{\text{ver}}(\sigma_2 \circ \sigma_1^{-1} \circ \sigma_2^{-1}) & \downarrow id(3) \\
 3 & \xrightarrow{\sigma_2 \circ \sigma_1^{-1} \circ \sigma_2^{-1}} & 3
 \end{array}$$

**Remark 4.1.2.50.** The 2-arrows  $\text{Triple}_{\text{eleven}}$ (one half) and  $\text{Triple}_{\text{eleven}}$ (other half) of 2-Braids express algebraically the two halves of the Roseman move known as the triple move, which allows us to replace

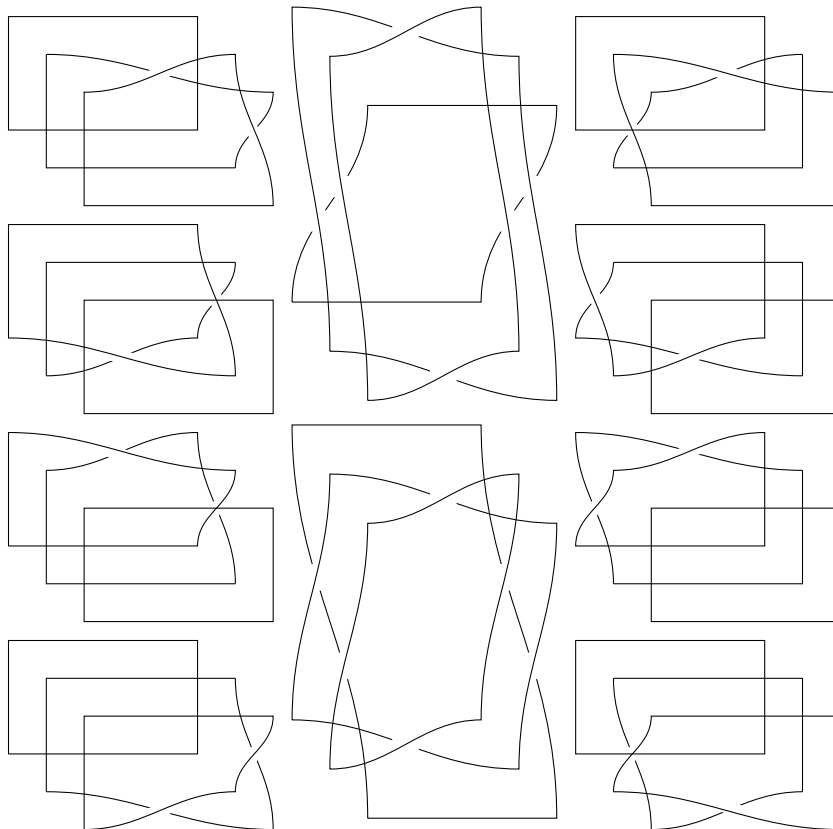

by the following, and vice versa.

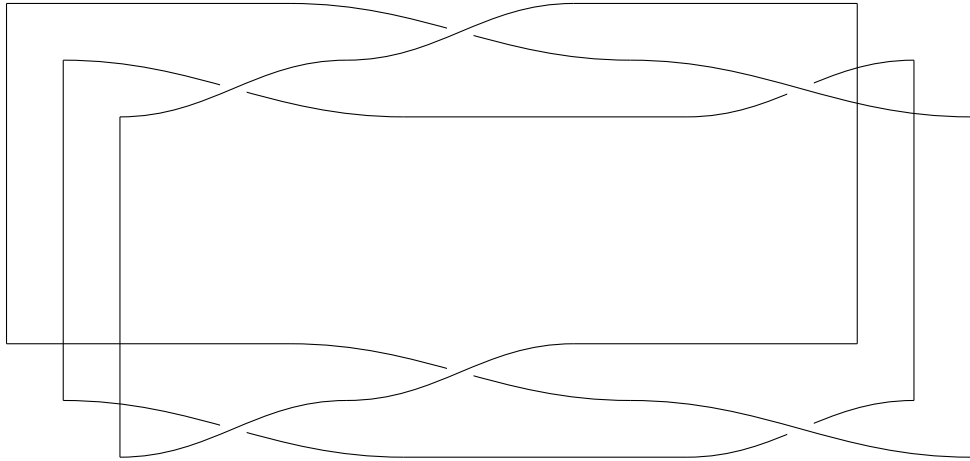

**Notation 4.1.2.51.** Let

$$F(\mathcal{S}) \xrightarrow{\text{Triple}_{\text{twelve}}(\text{one half})} \text{2-Braids}$$

be the functor of strict monoidal cubical 2-categories to which, by means of the universal property of  $F(\mathcal{S})$ , the functor

$$\mathcal{S} \longrightarrow \text{2-Braids}$$

corresponding to the 2-arrow of 2-Braids obtained by pasting together the following 2-arrows of 2-Braids gives rise.

$$\begin{array}{ccccccc}
3 & \xrightarrow{\sigma_2^{-1}} & 3 & \xrightarrow{\sigma_1^{-1}} & 3 & \xrightarrow{\sigma_2^{-1}} & 3 \\
\downarrow id(3) & & \downarrow \sigma_2 & & \downarrow \sigma_2^{-1} & & \downarrow id(3) \\
& 1 \otimes \sigma_{UURO} & & & 1 \otimes \sigma_{UULU} & & \\
3 & \xrightarrow{id(3)} & 3 & \xrightarrow{\sigma_{1TU}} & 3 & \xrightarrow{id(3)} & 3 \\
\downarrow id(3) & & \downarrow \sigma_1^{-1} & & \downarrow \sigma_1 & & \downarrow id(3) \\
& \sigma_{LURU} \otimes 1 & & & \sigma_{LULO} \otimes 1 & & \\
3 & \xrightarrow{\sigma_1^{-1}} & 3 & \xrightarrow{\sigma_2^{-1}} & 3 & \xrightarrow{\sigma_1^{-1}} & 3 \\
\downarrow id(3) & & \downarrow \sigma_1 & & \downarrow \sigma_1^{-1} & & \downarrow id(3) \\
& \sigma_{UURO} \otimes 1 & & & \sigma_{UULU} \otimes 1 & & \\
3 & \xrightarrow{id(3)} & 3 & \xrightarrow{\sigma_{2OT}} & 3 & \xrightarrow{id(3)} & 3 \\
\downarrow id(3) & & \downarrow \sigma_2^{-1} & & \downarrow \sigma_2 & & \downarrow id(3) \\
& 1 \otimes \sigma_{LURU} & & & 1 \otimes \sigma_{LULO} & & \\
3 & \xrightarrow{\sigma_2^{-1}} & 3 & \xrightarrow{\sigma_1^{-1}} & 3 & \xrightarrow{\sigma_2^{-1}} & 3
\end{array}$$

**Notation 4.1.2.52.** Let

$$F(\mathcal{S}) \xrightarrow{\text{Triple}_{\text{twelve}}(\text{other half})} \text{2-Braids}$$

be the functor of strict monoidal cubical 2-categories to which, by means of the universal property of  $F(\mathcal{S})$ , the functor

$$\mathcal{S} \longrightarrow \text{2-Braids}$$

corresponding to the 2-arrow of 2-Braids obtained by pasting together the following 2-arrows of 2-Braids gives rise.

$$\begin{array}{ccc}
3 & \xrightarrow{\sigma_2^{-1} \circ \sigma_1^{-1} \circ \sigma_2^{-1}} & 3 \\
id(3) \downarrow & id_{\text{ver}}(\sigma_2^{-1} \circ \sigma_1^{-1} \circ \sigma_2^{-1}) & \downarrow id(3) \\
3 & \xrightarrow{\sigma_2^{-1} \circ \sigma_1^{-1} \circ \sigma_2^{-1}} & 3
\end{array}$$

**Remark 4.1.2.53.** The 2-arrows  $\text{Triple}_{\text{twelve}}$ (one half) and  $\text{Triple}_{\text{twelve}}$ (other half) of 2-Braids express algebraically the two halves of the Roseman move known as the triple move, which allows us to replace

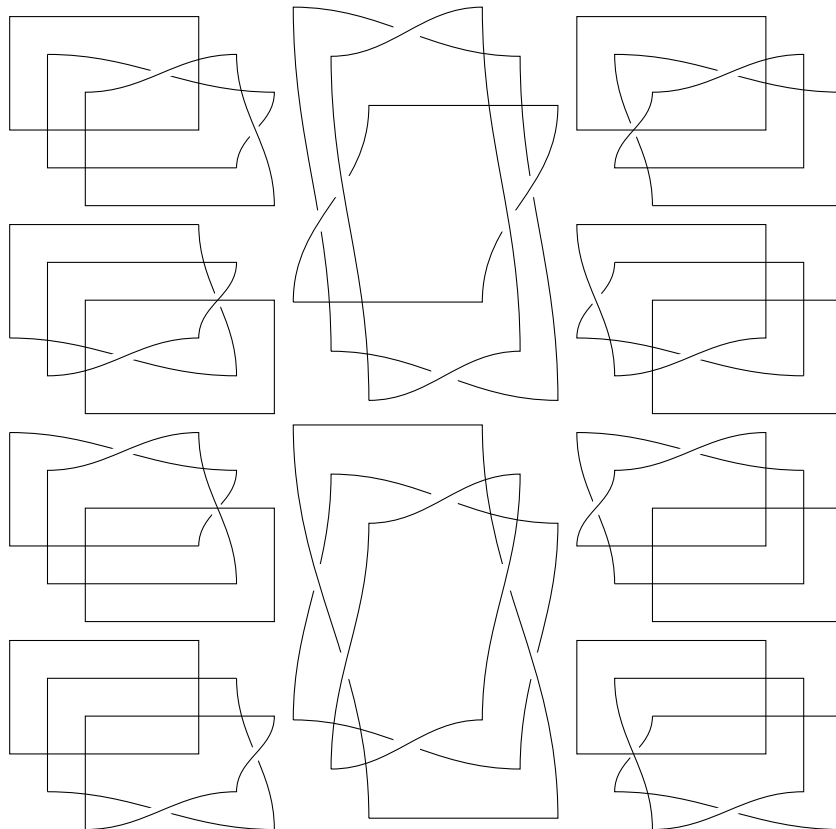

by the following, and vice versa.

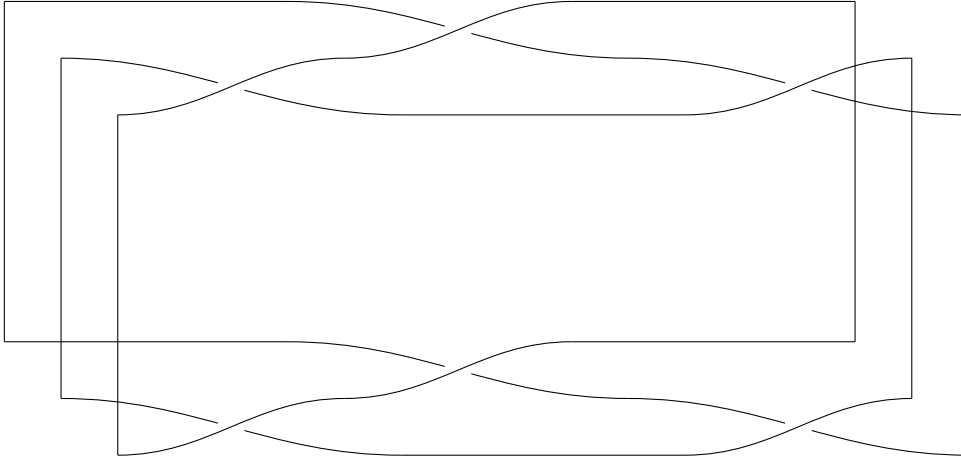

**Notation 4.1.2.54.** We denote the following 2-arrow

$$\begin{array}{ccc}
 2 & \xrightarrow{\sigma} & 2 \\
 id(2) \downarrow & & \downarrow id(2) \\
 2 & \xrightarrow{\sigma} & 2
 \end{array}$$

of 2-Braids by `VerticalOverCrossing`, or  $\sigma_{VO}$  for short.

**Notation 4.1.2.55.** We denote the following 2-arrow

$$\begin{array}{ccc}
 2 & \xrightarrow{\sigma^{-1}} & 2 \\
 id(2) \downarrow & & \downarrow id(2) \\
 2 & \xrightarrow{\sigma^{-1}} & 2
 \end{array}$$

of 2-Braids by `VerticalUnderCrossing`, or  $\sigma_{VU}$  for short.

**Notation 4.1.2.56.** We denote following 2-arrow

$$\begin{array}{ccc}
 2 & \xrightarrow{id(2)} & 2 \\
 \sigma \downarrow & & \downarrow \sigma \\
 2 & \xrightarrow{id(2)} & 2
 \end{array}$$

of 2-Braids by `HorizontalOverCrossing`, or  $\sigma_{HO}$  for short.



**Notation 4.1.2.57.** We denote the following 2-arrow

$$\begin{array}{ccc}
 2 & \xrightarrow{id(2)} & 2 \\
 \sigma^{-1} \downarrow & & \downarrow \sigma^{-1} \\
 2 & \xrightarrow{id(2)} & 2
 \end{array}$$

of 2-Braids by `HorizontalUnderCrossing`, or  $\sigma_{HU}$  for short.

**Notation 4.1.2.58.** To make the pasting diagram for the tetrahedralmove more readable, some of the notation is simplified. Every 1-arrow without notation is the identity. The identity 2-arrow,  $id(id(4))$ , is denoted by  $id$ . The 2-arrows have a number, 1,2 or 3, as an additional subscript. This number says which two planes that are crossing. If the number is  $i$ , then the  $i$ 'th and  $(i + 1)$ 'th plane cross. Other simplification is expressed in the following list.

- (1)  $S_1 = \sigma^{-1} \otimes \sigma^{-1}$
- (2)  $S_2 = \sigma_{HU} \otimes \sigma_{LURU}$
- (3)  $S_3 = \sigma_{LOLU} \otimes \sigma_{HU}$
- (4)  $S_4 = \sigma_{VU} \otimes \sigma_{HO}$
- (5)  $S_5 = \sigma_{LURU} \otimes \sigma_{HU}$
- (6)  $S_6 = \sigma_{HU} \otimes \sigma_{LULO}$
- (7)  $S_7 = \sigma_{UORU} \otimes \sigma_{HU}$
- (8)  $S_8 = \sigma_{HO} \otimes \sigma_{UULU}$
- (9)  $S_9 = \sigma_{HO} \otimes \sigma_{VU}$
- (10)  $S_{10} = \sigma_{HU} \otimes \sigma_{UORU}$
- (11)  $S_{11} = \sigma_{UULU} \otimes \sigma_{HU}$
- (12)  $\text{Trp}_1 = id(1) \otimes \sigma_{2OT}$
- (13)  $\text{Trp}_2 = id(1) \otimes \sigma_{2TO}$
- (14)  $\text{Trp}_3 = \sigma_{2TO} \otimes id(1)$
- (15)  $\text{Trp}_4 = id(1) \otimes \sigma_{2OU}$
- (16)  $\text{Trp}_5 = \sigma_{2OU} \otimes id(1)$

$$(17) \text{Trp}_6 = \sigma_{2\text{OT}} \otimes id(1)$$

**Notation 4.1.2.59.** Let

$$F(\mathcal{S}) \xrightarrow{\text{Tetrahedral}_{\text{one}}(\text{one half})} 2\text{-Braids}$$

be the functor of strict monoidal cubical 2-categories to which, by means of the universal property of  $F(\mathcal{S})$ , the functor

$$\mathcal{S} \longrightarrow 2\text{-Braids}$$

corresponding to the 2-arrow of 2-Braids obtained by pasting together the following 2-arrows of 2-Braids gives rise.

**Notation 4.1.2.60.** Let

$$F(\mathcal{S}) \xrightarrow{\text{Tetrahedral}_{\text{one}}(\text{other half})} 2\text{-Braids}$$

be the functor of strict monoidal cubical 2-categories to which, by means of the universal property of  $F(\mathcal{S})$ , the functor

$$\mathcal{S} \longrightarrow 2\text{-Braids}$$

corresponding to the 2-arrow of 2-Braids obtained by pasting together the following 2-arrows of 2-Braids gives rise.

**Remark 4.1.2.61.** The 2-arrows  $\text{Tetrahedral}_{\text{one}}(\text{one half})$  and  $\text{Tetrahedral}_{\text{one}}(\text{other half})$  of 2-Braids express algebraically the two halves of the Roseman move known as the saddle move, which allows us to replace

by the following, and vice versa.

**Notation 4.1.2.62.** Let

$$\begin{array}{ccc} F(\mathcal{S}) & \cdots & F(\mathcal{S}) \\ & \searrow & \swarrow \\ & i_1^{F(\mathcal{S}),66} & i_{66}^{F(\mathcal{S}),66} \\ & \downarrow & \downarrow \\ & \bigsqcup_{66} F(\mathcal{S}) & \end{array}$$

be a diagram in  $\text{Mon}(2\text{-Cat})$  which defines a coproduct of 66 copies of  $F(\mathcal{S})$ .

**Notation 4.1.2.63.** Let

$$\bigsqcup_{66} F(\mathcal{S}) \xrightarrow{\bigsqcup_{66} \text{one half moves}} 2\text{-Braids}$$

denote the canonical functor of strict monoidal cubical 2-categories such that the following hold.





(1) The following diagram in  $\text{Mon}(2\text{-Cat})$  commutes.

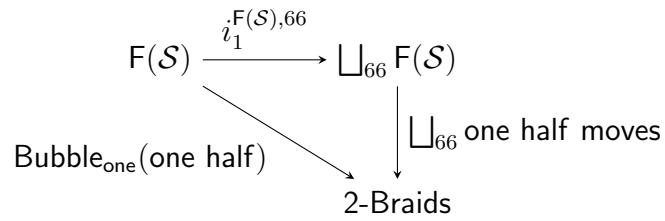

(2) The following diagram in  $\text{Mon}(2\text{-Cat})$  commutes.

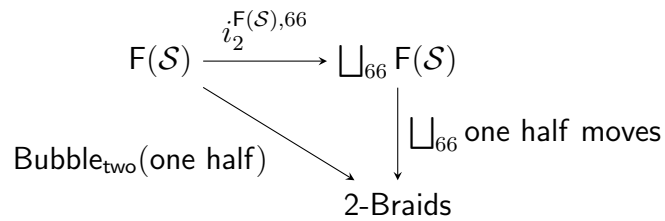

(3) The following diagram in  $\text{Mon}(2\text{-Cat})$  commutes.

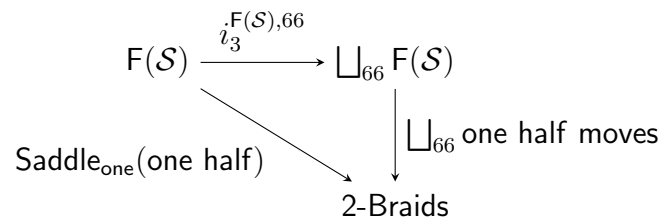

(4) The following diagram in  $\text{Mon}(2\text{-Cat})$  commutes.

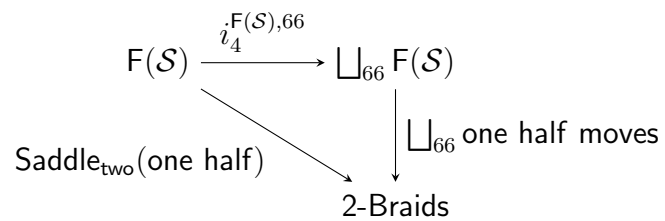

(5) The following diagram in  $\text{Mon}(2\text{-Cat})$  commutes.

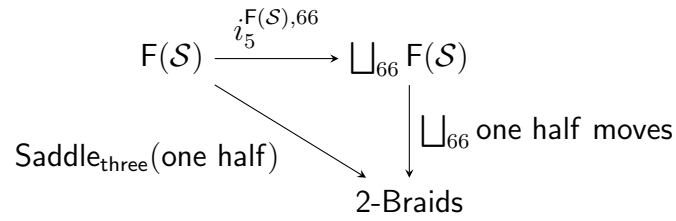

(6) The following diagram in  $\text{Mon}(2\text{-Cat})$  commutes.

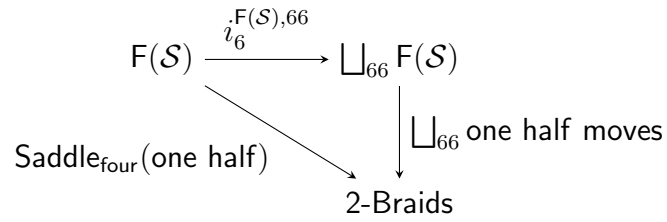

(7) The following diagram in  $\text{Mon}(2\text{-Cat})$  commutes.

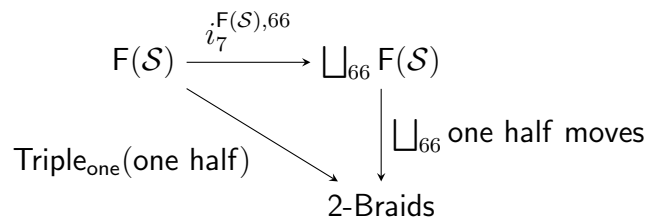

(8) The following diagram in  $\text{Mon}(2\text{-Cat})$  commutes.

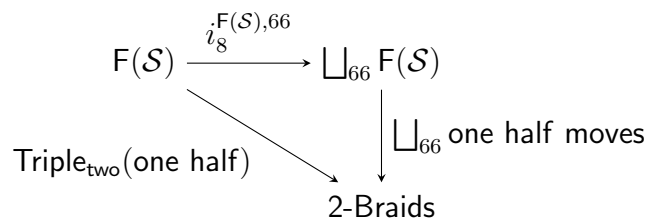

(9) The following diagram in  $\text{Mon}(2\text{-Cat})$  commutes.

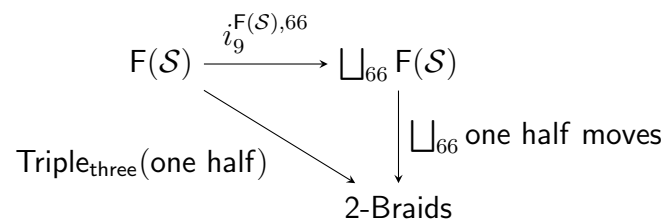

(10) The following diagram in  $\text{Mon}(2\text{-Cat})$  commutes.

$$\begin{array}{ccc}
 \mathcal{F}(\mathcal{S}) & \xrightarrow{i_{10}^{\mathcal{F}(\mathcal{S}),66}} & \sqcup_{66} \mathcal{F}(\mathcal{S}) \\
 \searrow \text{Triple}_{\text{four}}(\text{one half}) & & \downarrow \sqcup_{66} \text{one half moves} \\
 & & \text{2-Braids}
 \end{array}$$

(11) The following diagram in  $\text{Mon}(2\text{-Cat})$  commutes.

$$\begin{array}{ccc}
 \mathcal{F}(\mathcal{S}) & \xrightarrow{i_{11}^{\mathcal{F}(\mathcal{S}),66}} & \sqcup_{66} \mathcal{F}(\mathcal{S}) \\
 \searrow \text{Triple}_{\text{five}}(\text{one half}) & & \downarrow \sqcup_{66} \text{one half moves} \\
 & & \text{2-Braids}
 \end{array}$$

(12) The following diagram in  $\text{Mon}(2\text{-Cat})$  commutes.

$$\begin{array}{ccc}
 \mathcal{F}(\mathcal{S}) & \xrightarrow{i_{12}^{\mathcal{F}(\mathcal{S}),66}} & \sqcup_{66} \mathcal{F}(\mathcal{S}) \\
 \searrow \text{Triple}_{\text{six}}(\text{one half}) & & \downarrow \sqcup_{66} \text{one half moves} \\
 & & \text{2-Braids}
 \end{array}$$

(13) The following diagram in  $\text{Mon}(2\text{-Cat})$  commutes.

$$\begin{array}{ccc}
 \mathcal{F}(\mathcal{S}) & \xrightarrow{i_{13}^{\mathcal{F}(\mathcal{S}),66}} & \sqcup_{66} \mathcal{F}(\mathcal{S}) \\
 \searrow \text{Triple}_{\text{seven}}(\text{one half}) & & \downarrow \sqcup_{66} \text{one half moves} \\
 & & \text{2-Braids}
 \end{array}$$

(14) The following diagram in  $\text{Mon}(2\text{-Cat})$  commutes.

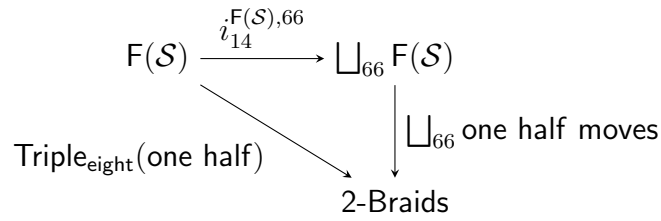

(15) The following diagram in  $\text{Mon}(2\text{-Cat})$  commutes.

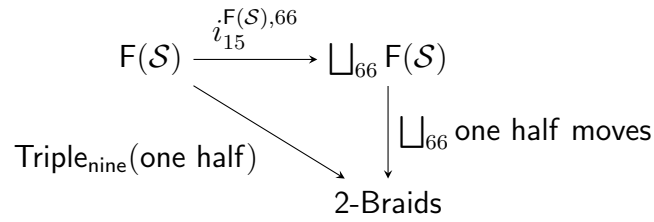

(16) The following diagram in  $\text{Mon}(2\text{-Cat})$  commutes.

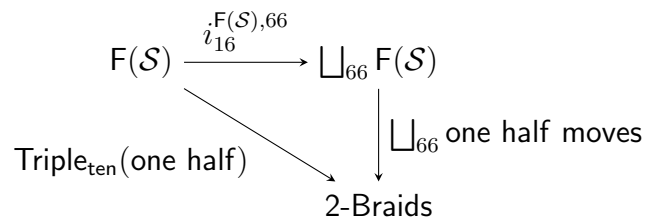

(17) The following diagram in  $\text{Mon}(2\text{-Cat})$  commutes.

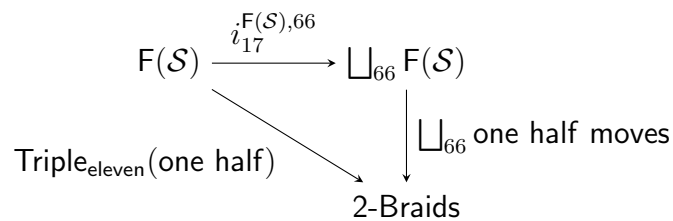

(18) The following diagram in  $\text{Mon}(2\text{-Cat})$  commutes.

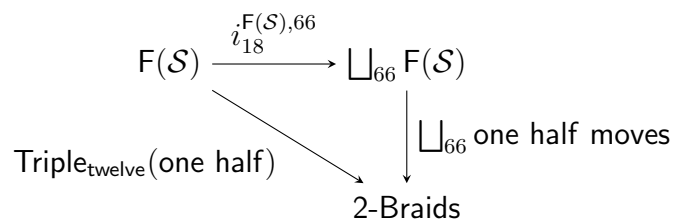



(19) The following diagram in  $\text{Mon}(2\text{-Cat})$  commutes.

$$\begin{array}{ccc}
 F(\mathcal{S}) & \xrightarrow{i_{19}^{F(\mathcal{S}),66}} & \sqcup_{66} F(\mathcal{S}) \\
 \searrow \text{Tetrahedral}_{\text{one}}(\text{one half}) & & \downarrow \sqcup_{66} \text{one half moves} \\
 & & 2\text{-Braids}
 \end{array}$$

⋮

(66) The following diagram in  $\text{Mon}(2\text{-Cat})$  commutes.

$$\begin{array}{ccc}
 F(\mathcal{S}) & \xrightarrow{i_{66}^{F(\mathcal{S}),66}} & \sqcup_{66} F(\mathcal{S}) \\
 \searrow \text{Tetrahedral}_{\text{fortyeight}}(\text{one half}) & & \downarrow \sqcup_{66} \text{one half moves} \\
 & & 2\text{-Braids}
 \end{array}$$

**Notation 4.1.2.64.** Let

$$\sqcup_{66} F(\mathcal{S}) \xrightarrow{\sqcup_{66} \text{other half moves}} 2\text{-Braids}$$

denote the canonical functor of strict monoidal cubical 2-categories such that the following hold.

(1) The following diagram in  $\text{Mon}(2\text{-Cat})$  commutes.

$$\begin{array}{ccc}
 F(\mathcal{S}) & \xrightarrow{i_1^{F(\mathcal{S}),66}} & \sqcup_{66} F(\mathcal{S}) \\
 \searrow \text{Bubble}_{\text{one}}(\text{other half}) & & \downarrow \sqcup_{66} \text{other half moves} \\
 & & 2\text{-Braids}
 \end{array}$$

(2) The following diagram in  $\text{Mon}(2\text{-Cat})$  commutes.

$$\begin{array}{ccc}
 F(\mathcal{S}) & \xrightarrow{i_2^{F(\mathcal{S}),66}} & \sqcup_{66} F(\mathcal{S}) \\
 \searrow \text{Bubble}_{\text{two}}(\text{other half}) & & \downarrow \sqcup_{66} \text{other half moves} \\
 & & 2\text{-Braids}
 \end{array}$$

(3) The following diagram in  $\text{Mon}(2\text{-Cat})$  commutes.

$$\begin{array}{ccc}
 F(\mathcal{S}) & \xrightarrow{i_3^{F(\mathcal{S}),66}} & \sqcup_{66} F(\mathcal{S}) \\
 \searrow \text{Saddle}_{\text{one}}(\text{other half}) & & \downarrow \sqcup_{66} \text{other half moves} \\
 & & 2\text{-Braids}
 \end{array}$$

(4) The following diagram in  $\text{Mon}(2\text{-Cat})$  commutes.

$$\begin{array}{ccc}
 F(\mathcal{S}) & \xrightarrow{i_4^{F(\mathcal{S}),66}} & \sqcup_{66} F(\mathcal{S}) \\
 \searrow \text{Saddle}_{\text{two}}(\text{other half}) & & \downarrow \sqcup_{66} \text{other half moves} \\
 & & 2\text{-Braids}
 \end{array}$$

(5) The following diagram in  $\text{Mon}(2\text{-Cat})$  commutes.

$$\begin{array}{ccc}
 F(\mathcal{S}) & \xrightarrow{i_5^{F(\mathcal{S}),66}} & \sqcup_{66} F(\mathcal{S}) \\
 \searrow \text{Saddle}_{\text{three}}(\text{other half}) & & \downarrow \sqcup_{66} \text{other half moves} \\
 & & 2\text{-Braids}
 \end{array}$$

(6) The following diagram in  $\text{Mon}(2\text{-Cat})$  commutes.

$$\begin{array}{ccc}
 F(\mathcal{S}) & \xrightarrow{i_6^{F(\mathcal{S}),66}} & \sqcup_{66} F(\mathcal{S}) \\
 \searrow \text{Saddle}_{\text{four}}(\text{other half}) & & \downarrow \sqcup_{66} \text{other half moves} \\
 & & 2\text{-Braids}
 \end{array}$$

(7) The following diagram in  $\text{Mon}(2\text{-Cat})$  commutes.

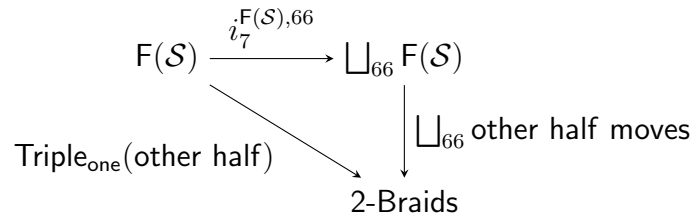

(8) The following diagram in  $\text{Mon}(2\text{-Cat})$  commutes.

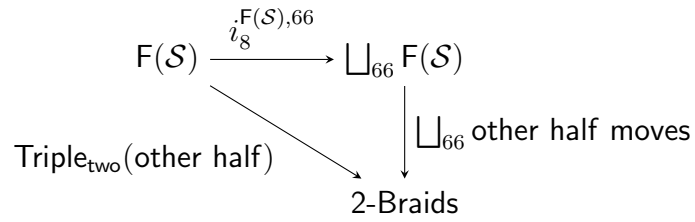

(9) The following diagram in  $\text{Mon}(2\text{-Cat})$  commutes.

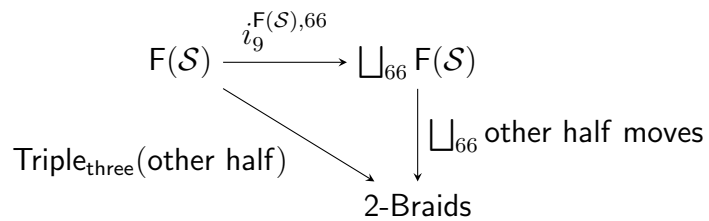

(10) The following diagram in  $\text{Mon}(2\text{-Cat})$  commutes.

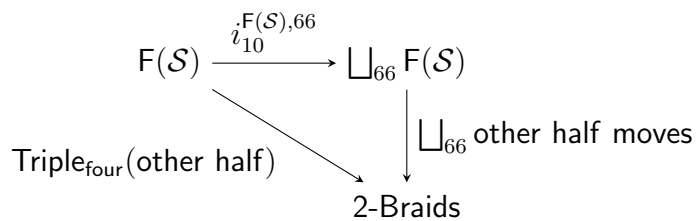

(11) The following diagram in  $\text{Mon}(2\text{-Cat})$  commutes.

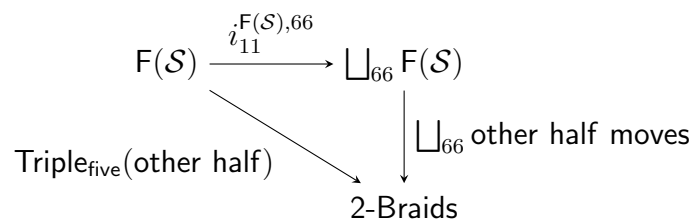

(12) The following diagram in  $\text{Mon}(2\text{-Cat})$  commutes.

$$\begin{array}{ccc}
 F(\mathcal{S}) & \xrightarrow{i_{12}^{F(\mathcal{S}),66}} & \sqcup_{66} F(\mathcal{S}) \\
 \searrow \text{Triple}_{\text{six}}(\text{other half}) & & \downarrow \sqcup_{66} \text{other half moves} \\
 & & 2\text{-Braids}
 \end{array}$$

(13) The following diagram in  $\text{Mon}(2\text{-Cat})$  commutes.

$$\begin{array}{ccc}
 F(\mathcal{S}) & \xrightarrow{i_{13}^{F(\mathcal{S}),66}} & \sqcup_{66} F(\mathcal{S}) \\
 \searrow \text{Triple}_{\text{seven}}(\text{other half}) & & \downarrow \sqcup_{66} \text{other half moves} \\
 & & 2\text{-Braids}
 \end{array}$$

(14) The following diagram in  $\text{Mon}(2\text{-Cat})$  commutes.

$$\begin{array}{ccc}
 F(\mathcal{S}) & \xrightarrow{i_{14}^{F(\mathcal{S}),66}} & \sqcup_{66} F(\mathcal{S}) \\
 \searrow \text{Triple}_{\text{eight}}(\text{other half}) & & \downarrow \sqcup_{66} \text{other half moves} \\
 & & 2\text{-Braids}
 \end{array}$$

(15) The following diagram in  $\text{Mon}(2\text{-Cat})$  commutes.

$$\begin{array}{ccc}
 F(\mathcal{S}) & \xrightarrow{i_{15}^{F(\mathcal{S}),66}} & \sqcup_{66} F(\mathcal{S}) \\
 \searrow \text{Triple}_{\text{nine}}(\text{other half}) & & \downarrow \sqcup_{66} \text{other half moves} \\
 & & 2\text{-Braids}
 \end{array}$$

(16) The following diagram in  $\text{Mon}(2\text{-Cat})$  commutes.

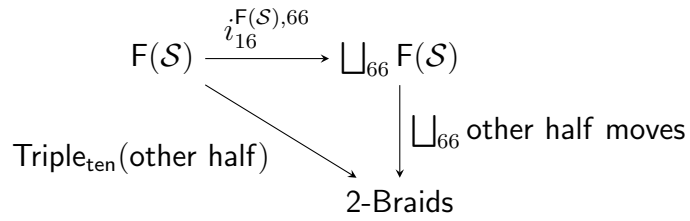

(17) The following diagram in  $\text{Mon}(2\text{-Cat})$  commutes.

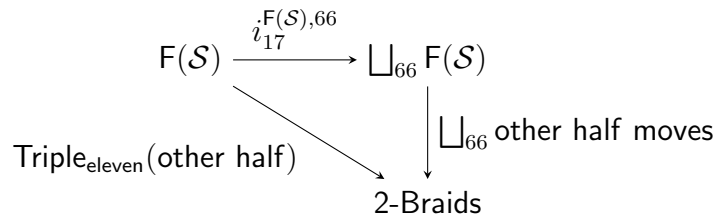

(18) The following diagram in  $\text{Mon}(2\text{-Cat})$  commutes.

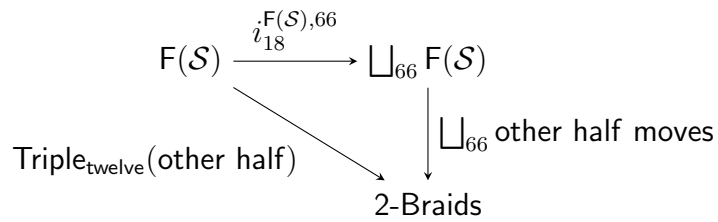

(19) The following diagram in  $\text{Mon}(2\text{-Cat})$  commutes.

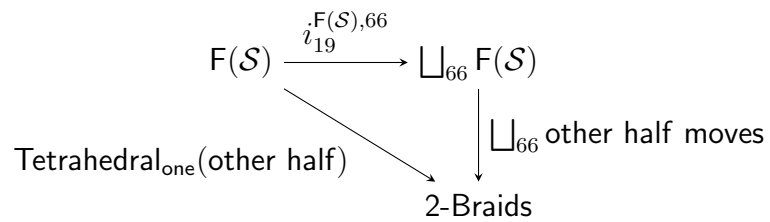

⋮

(66) The following diagram in  $\text{Mon}(2\text{-Cat})$  commutes.

$$\begin{array}{ccc}
F(\mathcal{S}) & \xrightarrow{i_{66}^{F(\mathcal{S}),66}} & \sqcup_{66} F(\mathcal{S}) \\
& \searrow \text{Tetrahedral}_{\text{fortyeight}}(\text{other half}) & \downarrow \sqcup_{66} \text{other half moves} \\
& & \text{2-Braids}
\end{array}$$

**Notation 4.1.2.65.** Let

$$\begin{array}{ccccc}
& & \sqcup_{66} \text{one half moves} & & \\
& & \longrightarrow & & \\
\sqcup_{66} F(\mathcal{S}) & \xrightarrow{\quad} & \text{2-Braids} & \xrightarrow{q_{\text{R-moves}}} & \text{2-Braids/R-moves} \\
& & \longleftarrow & & \\
& & \sqcup_{66} \text{other half moves} & & 
\end{array}$$

be a diagram in  $\text{Mon}(2\text{-Cat})$  which defines a coequaliser.

**Remark 4.1.2.66.** The underlying category of 2-Braids/R-moves is exactly Braids/R-moves. We shall, not, however, need this in our formal work, and omit a proof.

**Remark 4.1.2.67.** Let us regard a pair of 2-braids as equivalent if one can be obtained from the other by a finite sequence of Roseman moves, namely any of the Roseman moves  $\text{Bubble}_{\text{one}}$ ,  $\text{Bubble}_{\text{two}}$ ,  $\text{Saddle}_{\text{one}}$ ,  $\dots$ ,  $\text{Saddle}_{\text{four}}$ ,  $\text{Triple}_{\text{one}}$ ,  $\dots$ ,  $\text{Triple}_{\text{twelve}}$ ,  $\text{Tetrahedral}_{\text{one}}$ ,  $\dots$ ,  $\text{Tetrahedral}_{\text{twenty four}}$ . In other, we regard a pair of 2-braids as equivalent if they are *isotopic*. The 2-arrows of 2-Braids/R-moves can be thought of as arrows of 2-Braids, namely as 2-braids, up to isotopy.

## 4.2. Temperley-Lieb 2-categories and Markov trace functors

We define a cubical 2-category 2-TL in two steps. On objects and 1-arrows, 2-TL is identical to TL. We think of the 2-arrows of 2-TL as *diagrammatic 2-tangles*, which for us are planes and pieces of spheres joining four diagrammatic tangles which we depict as drawn on two of the pairs of opposite faces of a cube.

The first step is to define a cubical 2-category  $2\text{-TL}^{\text{double}}$  as the free strict monoidal cubical 2-category on a monoidal datum  $\mathbb{M}_{2\text{-TL}}$ . The 2-arrows of  $2\text{-TL}$  are generated by those diagrammatic 2-tangles which we shall make use of in §4.3 to smoothen the generating 2-arrows of  $2\text{-Braids}^{\text{double}}$ .

To obtain 2-TL from  $2\text{-TL}^{\text{double}}$ , we glue in 2-arrows which we think of as those diagrammatic 2-tangles which we shall make use of in §4.3 to smoothen the generating 2-arrows of 2-Braids which we think of as triple plane crossings. Formally, we express this glueing by means of a colimit  $\text{Mon}(2\text{-Cat})$ .

Having defined 2-TL, we introduce the notion of a datum for smoothing of 2-braids. Given such a datum  $\mathbb{S}$ , we define from TL a 3-ring  $\text{TL}(\mathbb{S})$  in two steps, via a 3-ring  $\text{TL}(\mathbb{S})^{\text{pre}}$ . We think of the arrows of  $\text{TL}(\mathbb{S})$  as linearisations of diagrammatic 2-tangles.

Following this, we introduce the notion of a Markov trace datum with respect to a 3-ring. Given such a datum  $\mathbb{T}$ , we construct a functor of 3-rings from  $\text{TL}(\mathbb{S})$  to a 3-ring  $\mathbb{T}$  defined by means of  $\mathbb{T}$ . On arrows, we think of this functor as defining a categorification to linearised diagrammatic 2-tangles of the Markov trace for linearised diagrammatic tangles constructed in §3.2.

Just as in §3.2.4 and §3.2.5 for 2-rings, one can, given a 3-ring  $\mathbb{R}$ , construct a datum for smoothing of 2-braids from it, and construct a Markov trace datum from it. We omit the details, which are a straightforward categorification of those of §3.2.4 and §3.2.5.

Work on 2-categories of 2-tangles has been carried out previously. We refer the reader to, for instance, the paper [1] of Baez and Langford, the earlier but erroneous paper [5] of Fischer, and §6.2 of the book [3] of Carter and Saito. However, our work is significantly different and novel in several ways. Perhaps the most important of these differences is that our definition of  $2\text{-TL}(\mathbb{S})$  is motivated by allowing us to carry out the notion of smoothing of 2-braids which we introduce in §4.3, rather by considering the higher categorical structures into which topological 2-tangles assemble.

### 4.2.1. The Temperley-Lieb 2-category

**Notation 4.2.1.1.** Throughout this section, we shall view the objects and arrows of  $\text{TL}_{\leq 2}$  as objects and arrows of TL via the functor

$$\text{TL}_{\leq 2} \xrightarrow{\text{can}_{\text{TL}}} \text{TL}.$$

Viewing the object  $1$  of  $\mathbb{T}\mathbb{L}_{\leq 2}$  as an object of  $\mathbb{T}\mathbb{L}$  in this way, we shall denote, for any integer  $n \geq 1$ , the object

$$\underbrace{1 \otimes_{\mathbb{T}\mathbb{L}} \cdots \otimes_{\mathbb{T}\mathbb{L}} 1}_n$$

of  $\mathbb{T}\mathbb{L}$  by  $n$ , and the object

$$\underbrace{1 \otimes_{\mathbb{T}\mathbb{L}(\mathbb{S})} \cdots \otimes_{\mathbb{T}\mathbb{L}(\mathbb{S})} 1}_n$$

of  $\mathbb{T}\mathbb{L}(\mathbb{S})$  by  $n$ .

**Notation 4.2.1.2.** Throughout this section, we view  $\mathbb{T}\mathbb{L}_{\leq 2}$  as a cubical 2-category with no non-identity 2-arrows.

**Notation 4.2.1.3.** Let us denote the 1-arrow

$$2 \xrightarrow{\text{CupAndCap}} 2$$

of  $\mathbb{T}\mathbb{L}_{\leq 2}$



by  $\tau$ .

**Notation 4.2.1.4.** Let us denote by  $\partial(\text{LowerRight})$  the functor

$$\partial\mathcal{S} \longrightarrow \mathbb{T}\mathbb{L}_{\leq 2}$$

corresponding to the following square in  $\mathbb{T}\mathbb{L}_{\leq 2}$ .

$$\begin{array}{ccc} 2 & \xrightarrow{id} & 2 \\ id \downarrow & & \downarrow \tau \\ 2 & \xrightarrow{\tau} & 2 \end{array}$$



**Notation 4.2.1.5.** Let us denote by  $\partial(\text{UpperRight})$  the functor

$$\partial\mathcal{S} \longrightarrow \mathbf{TL}_{\leq 2}$$

corresponding to the following square in  $\mathbf{TL}_{\leq 2}$ .

$$\begin{array}{ccc} 2 & \xrightarrow{\tau} & 2 \\ id \downarrow & & \downarrow \tau \\ 2 & \xrightarrow{id} & 2 \end{array}$$

**Notation 4.2.1.6.** Let us denote by  $\partial(\text{LowerLeft})$  the functor

$$\partial\mathcal{S} \longrightarrow \mathbf{TL}_{\leq 2}$$

corresponding to the following square in  $\mathbf{TL}_{\leq 2}$ .

$$\begin{array}{ccc} 2 & \xrightarrow{id} & 2 \\ \tau \downarrow & & \downarrow id \\ 2 & \xrightarrow{\tau} & 2 \end{array}$$

**Notation 4.2.1.7.** Let us denote by  $\partial(\text{UpperLeft})$  the functor

$$\partial\mathcal{S} \longrightarrow \mathbf{TL}_{\leq 2}$$

corresponding to the following square in  $\mathbf{TL}_{\leq 2}$ .

$$\begin{array}{ccc} 2 & \xrightarrow{\tau} & 2 \\ \tau \downarrow & & \downarrow id \\ 2 & \xrightarrow{id} & 2 \end{array}$$

**Notation 4.2.1.8.** Let

$$\begin{array}{ccc} \partial\mathcal{S} & \cdots & \partial\mathcal{S} \\ & \searrow & \swarrow \\ & i_1^{\partial\mathcal{S}, four} & i_4^{\partial\mathcal{S}, four} \\ & \downarrow & \downarrow \\ & \bigsqcup_4 \partial\mathcal{S} & \end{array}$$

be a diagram in 2-Cat which defines a coproduct of four copies of  $\partial\mathcal{S}$ .

**Notation 4.2.1.9.** Let

$$\begin{array}{ccc}
 \mathcal{S} & \dots & \mathcal{S} \\
 \searrow^{i_1^{\mathcal{S},four}} & & \swarrow_{i_4^{\mathcal{S},four}} \\
 & \sqcup_4 \mathcal{S} & 
 \end{array}$$

be a diagram in  $2\text{-Cat}$  which defines a coproduct of four copies of  $\mathcal{S}$ .

**Notation 4.2.1.10.** Let

$$\sqcup_8 \partial \mathcal{S} \xrightarrow{\sqcup_4 \iota} \sqcup_4 \mathcal{S}$$

denote the canonical functor such that the following diagram in  $2\text{-Cat}$  commutes for every  $1 \leq j \leq 4$ .

$$\begin{array}{ccc}
 \partial \mathcal{S} & \xrightarrow{i_j^{\partial \mathcal{S},four}} & \sqcup_4 \partial \mathcal{S} \\
 \downarrow \iota & & \downarrow \sqcup_4 \iota \\
 \mathcal{S} & \xrightarrow{i_j^{\mathcal{S},four}} & \sqcup_4 \mathcal{S}
 \end{array}$$

**Notation 4.2.1.11.** Let

$$\sqcup_4 \partial \mathcal{S} \xrightarrow{\sqcup \text{generators}} \text{TL}_{\leq 2}$$

denote the canonical functor such that the following hold.

- (1) The following diagram in  $2\text{-Cat}$  commutes.

$$\begin{array}{ccc}
 \partial \mathcal{S} & \xrightarrow{i_1^{\partial \mathcal{S},four}} & \sqcup_4 \partial \mathcal{S} \\
 \searrow \partial(\text{LowerRight}) & & \downarrow \sqcup \text{generators} \\
 & & \text{TL}_{\leq 2}
 \end{array}$$

- (2) The following diagram in  $2\text{-Cat}$  commutes.

$$\begin{array}{ccc}
\partial\mathcal{S} & \xrightarrow{i_2^{\partial\mathcal{S},four}} & \bigsqcup_4 \partial\mathcal{S} \\
& \searrow \partial(\text{UpperRight}) & \downarrow \bigsqcup \text{generators} \\
& & \text{TL}_{\leq 2}
\end{array}$$

(3) The following diagram in 2-Cat commutes.

$$\begin{array}{ccc}
\partial\mathcal{S} & \xrightarrow{i_3^{\partial\mathcal{S},four}} & \bigsqcup_4 \partial\mathcal{S} \\
& \searrow \partial(\text{LowerLeft}) & \downarrow \bigsqcup \text{generators} \\
& & \text{TL}_{\leq 2}
\end{array}$$

(4) The following diagram in 2-Cat commutes.

$$\begin{array}{ccc}
\partial\mathcal{S} & \xrightarrow{i_4^{\partial\mathcal{S},four}} & \bigsqcup_4 \partial\mathcal{S} \\
& \searrow \partial(\text{UpperLeft}) & \downarrow \bigsqcup \text{generators} \\
& & \text{TL}_{\leq 2}
\end{array}$$

**Notation 4.2.1.12.** Let

$$\begin{array}{ccc}
\bigsqcup_4 \partial\mathcal{S} & \xrightarrow{\bigsqcup_4 \iota} & \bigsqcup_4 \mathcal{S} \\
\downarrow \bigsqcup \text{generators} & & \downarrow r_0^{2\text{-TL}_{\leq 2}} \\
\text{TL}_{\leq 2} & \xrightarrow{r_1^{2\text{-TL}_{\leq 2}}} & 2\text{-TL}_{\leq 2}^{\text{double}}
\end{array}$$

be a co-cartesian square in 2-Cat.

**Notation 4.2.1.13.** We denote the 2-arrow of  $2\text{-TL}_{\leq 2}^{\text{double}}$  corresponding to the functor

$$\mathcal{S} \xrightarrow{r_0^{2\text{-TL}_{\leq 2}^{\text{double}}} \circ i_1^{\mathcal{S},four}} 2\text{-TL}_{\leq 2}^{\text{double}}$$

by  $\text{LowerRight}$ , or  $\tau_{\text{LR}}$  for short, and depict it as follows.

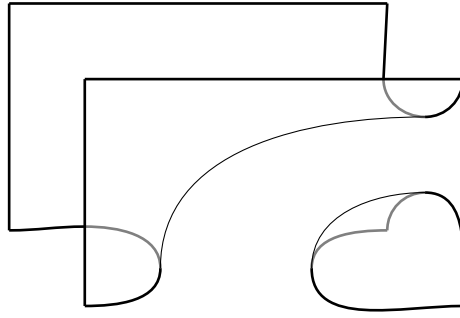

**Notation 4.2.1.14.** We denote the 2-arrow of  $2\text{-TL}_{\leq 2}^{\text{double}}$  corresponding to the functor

$$\mathcal{S} \xrightarrow{r_0^{2\text{-TL}_{\leq 2}^{\text{double}}} \circ i_2^{\mathcal{S}, \text{four}}} 2\text{-TL}_{\leq 2}^{\text{double}}$$

by **UpperRight**, or  $\tau_{\text{UR}}$  for short, and depict it as follows.

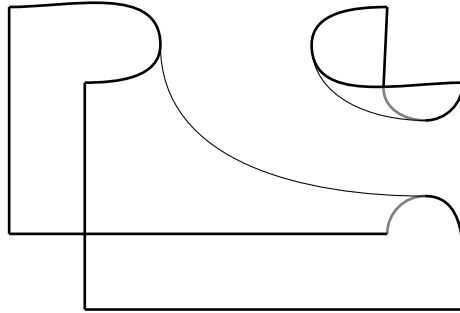

**Notation 4.2.1.15.** We denote the 2-arrow of  $2\text{-TL}_{\leq 2}^{\text{double}}$  corresponding to the functor

$$\mathcal{S} \xrightarrow{r_0^{2\text{-TL}_{\leq 2}^{\text{double}}} \circ i_3^{\mathcal{S}, \text{four}}} 2\text{-TL}_{\leq 2}^{\text{double}}$$

by **LowerLeft**, or  $\tau_{\text{LL}}$  for short, and depict it as follows.

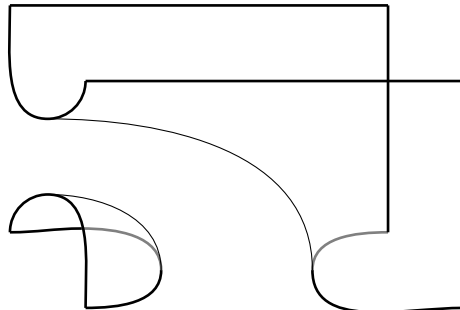

**Notation 4.2.1.16.** We denote the 2-arrow of  $2\text{-TL}_{\leq 2}^{\text{double}}$  corresponding to the functor

$$\mathcal{S} \xrightarrow{r_0 \circ i_3^{S, \text{four}}} 2\text{-TL}_{\leq 2}^{\text{double}}$$

by `UpperLeft`, or  $\tau_{\text{UL}}$  for short, and depict it as follows.

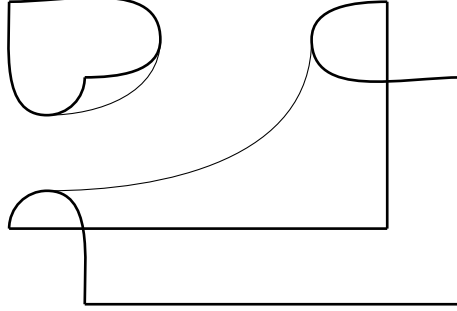

**Notation 4.2.1.17.** We shall view the objects and arrows of  $\text{TL}_{\leq 2}$  as objects and 1-arrows of  $2\text{-TL}_{\leq 2}^{\text{double}}$ , via the functor

$$\text{TL}_{\leq 2} \xrightarrow{r_1} 2\text{-TL}_{\leq 2}^{\text{double}}.$$

**Notation 4.2.1.18.** Let

$$2\text{-TL}_{\leq 2}^{\text{double}} \xleftarrow{p_1} 2\text{-TL}_{\leq 2}^{\text{double}} \times 2\text{-TL}_{\leq 2}^{\text{double}} \xrightarrow{p_2} 2\text{-TL}_{\leq 2}^{\text{double}}$$

be a diagram in  $2\text{-Cat}$  which defines a binary product.

**Notation 4.2.1.19.** Let

$$1_{2\text{-Cat}} \xrightarrow{(1, 1)} 2\text{-TL}_{\leq 2}^{\text{double}} \times 2\text{-TL}_{\leq 2}^{\text{double}}$$

be the canonical functor such that the following diagram in  $2\text{-Cat}$  commutes.

$$\begin{array}{ccccc}
 & & 1_{2\text{-Cat}} & & \\
 & \swarrow & \downarrow & \searrow & \\
 & 1 & (1, 1) & 1 & \\
 & \swarrow & \downarrow & \searrow & \\
 2\text{-TL}_{\leq 2}^{\text{double}} & \xleftarrow{p_1} & 2\text{-TL}_{\leq 2}^{\text{double}} \times 2\text{-TL}_{\leq 2}^{\text{double}} & \xrightarrow{p_2} & 2\text{-TL}_{\leq 2}^{\text{double}}
 \end{array}$$

**Definition 4.2.1.20.** The *Temperley-Lieb 2-category for 2-braids with double plane crossings* is, appealing to Fact 2.2.1.4, the free strict monoidal cubical 2-category on the monoidal datum  $\mathbb{M}_{2\text{-TL}^{\text{double}}} = (1_{2\text{-Cat}}, 2\text{-TL}_{\leq 2}^{\text{double}}, (1, 1), 2)$  internal to  $2\text{-Cat}$ .

**Notation 4.2.1.21.** We denote the Temperley-Lieb 2-category for 2-braids with double plane crossings by  $2\text{-TL}^{\text{double}}$ . We denote by  $\text{can}_{2\text{-TL}^{\text{double}}}$  the canonical functor

$$2\text{-TL}_{\leq 2} \longrightarrow 2\text{-TL}^{\text{double}}.$$

**Notation 4.2.1.22.** Let us denote by  $\partial\tau_1^{2,t}$  the canonical functor of strict monoidal cubical 2-categories

$$F(\partial\mathcal{S}) \longrightarrow 2\text{-TL}^{\text{double}}$$

to which the functor

$$\partial\mathcal{S} \longrightarrow 2\text{-TL}^{\text{double}}$$

corresponding to the following square of 1-arrows in  $2\text{-TL}^{\text{double}}$  gives rise, by means of the universal property of  $F(\partial\mathcal{S})$ .

$$\begin{array}{ccc} 3 & \xrightarrow{id(3)} & 3 \\ \tau_1 \downarrow & & \downarrow \tau_2 \\ 3 & \xrightarrow{id(3)} & 3 \end{array}$$

**Notation 4.2.1.23.** Let us denote by  $\partial\tau_2^{2,t}$  the canonical functor of strict monoidal cubical 2-categories

$$F(\partial\mathcal{S}) \longrightarrow 2\text{-TL}^{\text{double}}$$

to which the functor

$$\partial\mathcal{S} \longrightarrow 2\text{-TL}^{\text{double}}$$

corresponding to the following square of 1-arrows in  $2\text{-TL}^{\text{double}}$  gives rise, by means of the universal property of  $F(\partial\mathcal{S})$ .

$$\begin{array}{ccc} 3 & \xrightarrow{id(3)} & 3 \\ \tau_2 \downarrow & & \downarrow \tau_1 \\ 3 & \xrightarrow{id(3)} & 3 \end{array}$$

**Notation 4.2.1.24.** Let us denote by  $\partial\tau_3^{2,t}$  the canonical functor of strict monoidal cubical 2-categories

$$F(\partial\mathcal{S}) \longrightarrow 2\text{-TL}^{\text{double}}$$

to which the functor

$$\partial\mathcal{S} \longrightarrow 2\text{-TL}^{\text{double}}$$

corresponding to the following square of 1-arrows in  $2\text{-TL}^{\text{double}}$  gives rise, by means of the universal property of  $F(\partial\mathcal{S})$ .

$$\begin{array}{ccc} 3 & \xrightarrow{\tau_1} & 3 \\ id(3) \downarrow & & \downarrow id(3) \\ 3 & \xrightarrow{\tau_2} & 3 \end{array}$$

**Notation 4.2.1.25.** Let us denote by  $\partial\tau_4^{2,t}$  the canonical functor of strict monoidal cubical 2-categories

$$F(\partial\mathcal{S}) \longrightarrow 2\text{-TL}^{\text{double}}$$

to which the functor

$$\partial\mathcal{S} \longrightarrow 2\text{-TL}^{\text{double}}$$

corresponding to the following square of 1-arrows in  $2\text{-TL}^{\text{double}}$  gives rise, by means of the universal property of  $F(\partial\mathcal{S})$ .

$$\begin{array}{ccc} 3 & \xrightarrow{\tau_2} & 3 \\ id(3) \downarrow & & \downarrow id(3) \\ 3 & \xrightarrow{\tau_1} & 3 \end{array}$$

**Notation 4.2.1.26.** Let us denote by  $\partial\tau_5^{2,t}$  the canonical functor of strict monoidal cubical 2-categories

$$F(\partial\mathcal{S}) \longrightarrow 2\text{-TL}^{\text{double}}$$

to which the functor

$$\partial\mathcal{S} \longrightarrow 2\text{-TL}^{\text{double}}$$

corresponding to the following square of 1-arrows in  $2\text{-TL}^{\text{double}}$  gives rise, by means of the universal property of  $F(\partial\mathcal{S})$ .

$$\begin{array}{ccc} 3 & \xrightarrow{id(3)} & 3 \\ \tau_2 \circ \tau_1 \downarrow & & \downarrow \tau_2 \circ \tau_1 \\ 3 & \xrightarrow{id(3)} & 3 \end{array}$$

**Notation 4.2.1.27.** Let us denote by  $\partial\tau_6^{2,t}$  the canonical functor of strict monoidal cubical 2-categories

$$F(\partial\mathcal{S}) \longrightarrow 2\text{-TL}^{\text{double}}$$

to which the functor

$$\partial\mathcal{S} \longrightarrow 2\text{-TL}^{\text{double}}$$

corresponding to the following square of 1-arrows in  $2\text{-TL}^{\text{double}}$  gives rise, by means of the universal property of  $F(\partial\mathcal{S})$ .

$$\begin{array}{ccc} 3 & \xrightarrow{id(3)} & 3 \\ \tau_1 \circ \tau_2 \downarrow & & \downarrow \tau_1 \circ \tau_2 \\ 3 & \xrightarrow{id(3)} & 3 \end{array}$$

**Notation 4.2.1.28.** Let us denote by  $\partial\tau_7^{2,t}$  the canonical functor of strict monoidal cubical 2-categories

$$F(\partial\mathcal{S}) \longrightarrow 2\text{-TL}^{\text{double}}$$

to which the functor

$$\partial\mathcal{S} \longrightarrow 2\text{-TL}^{\text{double}}$$

corresponding to the following square of 1-arrows in  $2\text{-TL}^{\text{double}}$  gives rise, by means of the universal property of  $F(\partial\mathcal{S})$ .



$$\begin{array}{ccc}
3 & \xrightarrow{\tau_1} & 3 \\
\tau_1 \downarrow & & \downarrow \tau_2 \\
3 & \xrightarrow{\tau_2} & 3
\end{array}$$

**Notation 4.2.1.29.** Let us denote by  $\partial\tau_8^{2,t}$  the canonical functor of strict monoidal cubical 2-categories

$$F(\partial\mathcal{S}) \longrightarrow 2\text{-TL}^{\text{double}}$$

to which the functor

$$\partial\mathcal{S} \longrightarrow 2\text{-TL}^{\text{double}}$$

corresponding to the following square of 1-arrows in  $2\text{-TL}^{\text{double}}$  gives rise, by means of the universal property of  $F(\partial\mathcal{S})$ .

$$\begin{array}{ccc}
3 & \xrightarrow{\tau_1} & 3 \\
\tau_2 \downarrow & & \downarrow \tau_1 \\
3 & \xrightarrow{\tau_2} & 3
\end{array}$$

**Notation 4.2.1.30.** Let us denote by  $\partial\tau_9^{2,t}$  the canonical functor of strict monoidal cubical 2-categories

$$F(\partial\mathcal{S}) \longrightarrow 2\text{-TL}^{\text{double}}$$

to which the functor

$$\partial\mathcal{S} \longrightarrow 2\text{-TL}^{\text{double}}$$

corresponding to the following square of 1-arrows in  $2\text{-TL}^{\text{double}}$  gives rise, by means of the universal property of  $F(\partial\mathcal{S})$ .

$$\begin{array}{ccc}
3 & \xrightarrow{\tau_2} & 3 \\
\tau_1 \downarrow & & \downarrow \tau_2 \\
3 & \xrightarrow{\tau_1} & 3
\end{array}$$

**Notation 4.2.1.31.** Let us denote by  $\partial\tau_{10}^{2,t}$  the canonical functor of strict monoidal cubical 2-categories

$$F(\partial\mathcal{S}) \longrightarrow 2\text{-TL}^{\text{double}}$$

to which the functor

$$\partial\mathcal{S} \longrightarrow 2\text{-TL}^{\text{double}}$$

corresponding to the following square of 1-arrows in  $2\text{-TL}^{\text{double}}$  gives rise, by means of the universal property of  $F(\partial\mathcal{S})$ .

$$\begin{array}{ccc} 3 & \xrightarrow{\tau_2} & 3 \\ \tau_2 \downarrow & & \downarrow \tau_1 \\ 3 & \xrightarrow{\tau_1} & 3 \end{array}$$

**Notation 4.2.1.32.** Let us denote by  $\partial\tau_{11}^{2,t}$  the canonical functor of strict monoidal cubical 2-categories

$$F(\partial\mathcal{S}) \longrightarrow 2\text{-TL}^{\text{double}}$$

to which the functor

$$\partial\mathcal{S} \longrightarrow 2\text{-TL}^{\text{double}}$$

corresponding to the following square of 1-arrows in  $2\text{-TL}^{\text{double}}$  gives rise, by means of the universal property of  $F(\partial\mathcal{S})$ .

$$\begin{array}{ccc} 3 & \xrightarrow{\tau_1} & 3 \\ \tau_1 \circ \tau_2 \downarrow & & \downarrow \tau_1 \circ \tau_2 \\ 3 & \xrightarrow{\tau_2} & 3 \end{array}$$

**Notation 4.2.1.33.** Let us denote by  $\partial\tau_{12}^{2,t}$  the canonical functor of strict monoidal cubical 2-categories

$$F(\partial\mathcal{S}) \longrightarrow 2\text{-TL}^{\text{double}}$$

to which the functor

$$\partial\mathcal{S} \longrightarrow 2\text{-TL}^{\text{double}}$$

corresponding to the following square of 1-arrows in  $2\text{-TL}^{\text{double}}$  gives rise, by means of the universal property of  $F(\partial\mathcal{S})$ .

$$\begin{array}{ccc} 3 & \xrightarrow{\tau_2} & 3 \\ \tau_2 \circ \tau_1 \downarrow & & \downarrow \tau_2 \circ \tau_1 \\ 3 & \xrightarrow{\tau_1} & 3 \end{array}$$

**Notation 4.2.1.34.** Let

$$\bigsqcup_{12} F(\partial\mathcal{S}) \xrightarrow{\bigsqcup \text{generators}} 2\text{-TL}^{\text{double}}$$

denote the canonical functor of strict monoidal cubical 2-categories such that the following hold.

(1) The following diagram in  $\text{Mon}(2\text{-Cat})$  commutes.

$$\begin{array}{ccc} F(\partial\mathcal{S}) & \xrightarrow{i_1^{\cdot F(\partial\mathcal{S}), \text{twelve}}} & \bigsqcup_{12} F(\partial\mathcal{S}) \\ & \searrow \partial(\tau_1^{2,t}) & \downarrow \bigsqcup \text{generators} \\ & & 2\text{-TL}^{\text{double}} \end{array}$$

(2) The following diagram in  $\text{Mon}(2\text{-Cat})$  commutes.

$$\begin{array}{ccc} F(\partial\mathcal{S}) & \xrightarrow{i_2^{\cdot F(\partial\mathcal{S}), \text{twelve}}} & \bigsqcup_{12} F(\partial\mathcal{S}) \\ & \searrow \partial(\tau_2^{2,t}) & \downarrow \bigsqcup \text{generators} \\ & & 2\text{-TL}^{\text{double}} \end{array}$$

(3) The following diagram in  $\text{Mon}(2\text{-Cat})$  commutes.

$$\begin{array}{ccc} F(\partial\mathcal{S}) & \xrightarrow{i_3^{\cdot F(\partial\mathcal{S}), \text{twelve}}} & \bigsqcup_{12} F(\partial\mathcal{S}) \\ & \searrow \partial(\tau_3^{2,t}) & \downarrow \bigsqcup \text{generators} \\ & & 2\text{-TL}^{\text{double}} \end{array}$$

(4) The following diagram in  $\mathbf{Mon}(2\text{-Cat})$  commutes.

$$\begin{array}{ccc}
 \mathbf{F}(\partial\mathcal{S}) & \xrightarrow[\iota_4]{\cdot\mathbf{F}(\partial\mathcal{S}),\text{twelve}} & \sqcup_{12} \mathbf{F}(\partial\mathcal{S}) \\
 & \searrow \partial(\tau_4^{2,t}) & \downarrow \sqcup \text{generators} \\
 & & 2\text{-TL}^{\text{double}}
 \end{array}$$

(5) The following diagram in  $\mathbf{Mon}(2\text{-Cat})$  commutes.

$$\begin{array}{ccc}
 \mathbf{F}(\partial\mathcal{S}) & \xrightarrow[\iota_5]{\cdot\mathbf{F}(\partial\mathcal{S}),\text{twelve}} & \sqcup_{12} \mathbf{F}(\partial\mathcal{S}) \\
 & \searrow \partial(\tau_5^{2,t}) & \downarrow \sqcup \text{generators} \\
 & & 2\text{-TL}^{\text{double}}
 \end{array}$$

(6) The following diagram in  $\mathbf{Mon}(2\text{-Cat})$  commutes.

$$\begin{array}{ccc}
 \mathbf{F}(\partial\mathcal{S}) & \xrightarrow[\iota_6]{\cdot\mathbf{F}(\partial\mathcal{S}),\text{twelve}} & \sqcup_{12} \mathbf{F}(\partial\mathcal{S}) \\
 & \searrow \partial(\tau_6^{2,t}) & \downarrow \sqcup \text{generators} \\
 & & 2\text{-TL}^{\text{double}}
 \end{array}$$

(7) The following diagram in  $\mathbf{Mon}(2\text{-Cat})$  commutes.

$$\begin{array}{ccc}
 \mathbf{F}(\partial\mathcal{S}) & \xrightarrow[\iota_7]{\cdot\mathbf{F}(\partial\mathcal{S}),\text{twelve}} & \sqcup_{12} \mathbf{F}(\partial\mathcal{S}) \\
 & \searrow \partial(\tau_7^{2,t}) & \downarrow \sqcup \text{generators} \\
 & & 2\text{-TL}^{\text{double}}
 \end{array}$$

(8) The following diagram in  $\mathbf{Mon}(2\text{-Cat})$  commutes.

$$\begin{array}{ccc}
F(\partial\mathcal{S}) & \xrightarrow{i_8^{F(\partial\mathcal{S}),twelve}} & \bigsqcup_{12} F(\partial\mathcal{S}) \\
& \searrow \partial(\tau_8^{2,t}) & \downarrow \bigsqcup \text{generators} \\
& & 2\text{-TL}^{\text{double}}
\end{array}$$

(9) The following diagram in  $\text{Mon}(2\text{-Cat})$  commutes.

$$\begin{array}{ccc}
F(\partial\mathcal{S}) & \xrightarrow{i_9^{F(\partial\mathcal{S}),twelve}} & \bigsqcup_{12} F(\partial\mathcal{S}) \\
& \searrow \partial(\tau_9^{2,t}) & \downarrow \bigsqcup \text{generators} \\
& & 2\text{-TL}^{\text{double}}
\end{array}$$

(10) The following diagram in  $\text{Mon}(2\text{-Cat})$  commutes.

$$\begin{array}{ccc}
F(\partial\mathcal{S}) & \xrightarrow{i_{10}^{F(\partial\mathcal{S}),twelve}} & \bigsqcup_{12} F(\partial\mathcal{S}) \\
& \searrow \partial(\tau_{10}^{2,t}) & \downarrow \bigsqcup \text{generators} \\
& & 2\text{-TL}^{\text{double}}
\end{array}$$

(11) The following diagram in  $\text{Mon}(2\text{-Cat})$  commutes.

$$\begin{array}{ccc}
F(\partial\mathcal{S}) & \xrightarrow{i_{11}^{F(\partial\mathcal{S}),twelve}} & \bigsqcup_{12} F(\partial\mathcal{S}) \\
& \searrow \partial(\tau_{11}^{2,t}) & \downarrow \bigsqcup \text{generators} \\
& & 2\text{-TL}^{\text{double}}
\end{array}$$

(12) The following diagram in  $\text{Mon}(2\text{-Cat})$  commutes.

$$\begin{array}{ccc}
F(\partial\mathcal{S}) & \xrightarrow{i_{12}^{F(\partial\mathcal{S}),twelve}} & \bigsqcup_{12} F(\partial\mathcal{S}) \\
& \searrow \partial(\tau_{12}^{2,t}) & \downarrow \bigsqcup \text{generators} \\
& & 2\text{-TL}^{\text{double}}
\end{array}$$

**Notation 4.2.1.35.** Let

$$\begin{array}{ccc}
 \bigsqcup_{12} F(\partial\mathcal{S}) & \xrightarrow{\bigsqcup_{12} \iota} & \bigsqcup_{12} F(\mathcal{S}) \\
 \bigsqcup_{12} \text{generators} \downarrow & & \downarrow r_0^{2\text{-TL}} \\
 2\text{-TL}^{\text{double}} & \xrightarrow{r_1^{2\text{-TL}}} & 2\text{-TL}
 \end{array}$$

be a co-cartesian square in  $\text{Mon}(2\text{-Cat})$ .

**Terminology 4.2.1.36.** We refer to 2-TL as the *Temperley-Lieb 2-category*.

**Notation 4.2.1.37.** We denote the functor of strict monoidal 2-categories

$$2\text{-TL}^{\text{double}} \xrightarrow{r_1^{2\text{-TL}}} 2\text{-TL}$$

by  $\text{can}_{2\text{-TL}}$ .

**Notation 4.2.1.38.** We denote the 2-arrow of 2-TL corresponding to the functor

$$\mathcal{S} \xrightarrow{r_0^{2\text{-TL}} \circ \iota_1^{F(\mathcal{S}), \text{twelve}} \circ \text{can}_{\mathcal{S}}} 2\text{-TL}^{\text{double}}$$

by  $\tau_1^{2,t}$ , and depict it as follows.

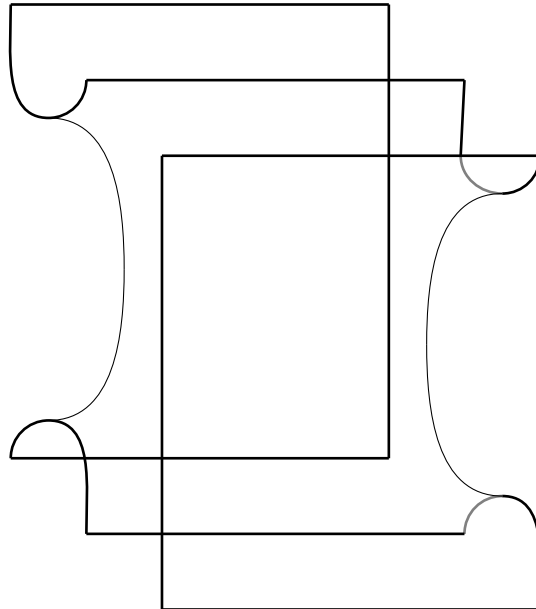

**Notation 4.2.1.39.** We denote the 2-arrow of 2-TL corresponding to the functor

$$\mathcal{S} \xrightarrow{r_0^{2\text{-TL}} \circ i_2^{F(\mathcal{S}), \text{twelve}} \circ \text{can}_{\mathcal{S}}} 2\text{-TL}^{\text{double}}$$

by  $\tau_2^{2,t}$ , and depict it as follows.

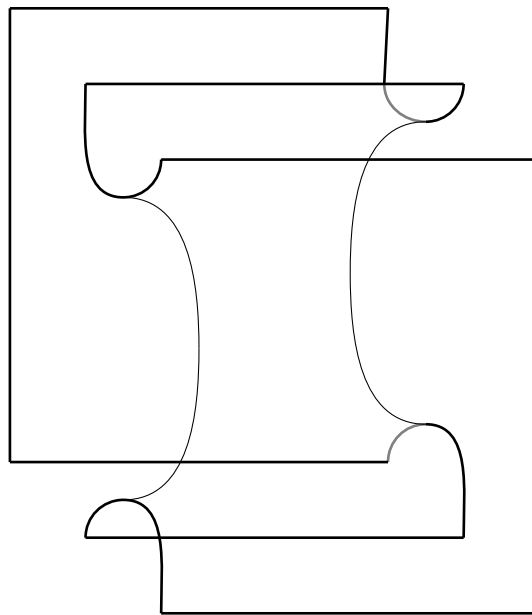

**Notation 4.2.1.40.** We denote the 2-arrow of 2-TL corresponding to the functor

$$\mathcal{S} \xrightarrow{r_0^{2\text{-TL}} \circ i_3^{F(\mathcal{S}), \text{twelve}} \circ \text{can}_{\mathcal{S}}} 2\text{-TL}^{\text{double}}$$

by  $\tau_3^{2,t}$ , and depict it as follows.

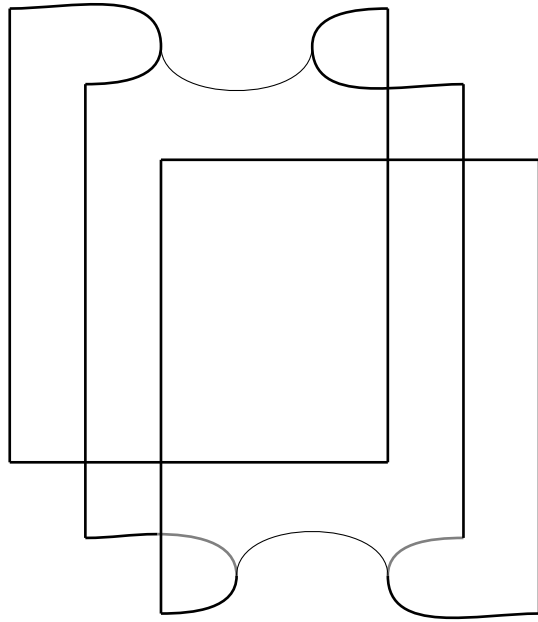

**Notation 4.2.1.41.** We denote the 2-arrow of 2-TL corresponding to the functor

$$\mathcal{S} \xrightarrow{r_0^{2\text{-TL}} \circ i_4^{F(\mathcal{S}), \text{twelve}} \circ \text{can}_{\mathcal{S}}} 2\text{-TL}^{\text{double}}$$

by  $\tau_4^{2,t}$ , and depict it as follows.

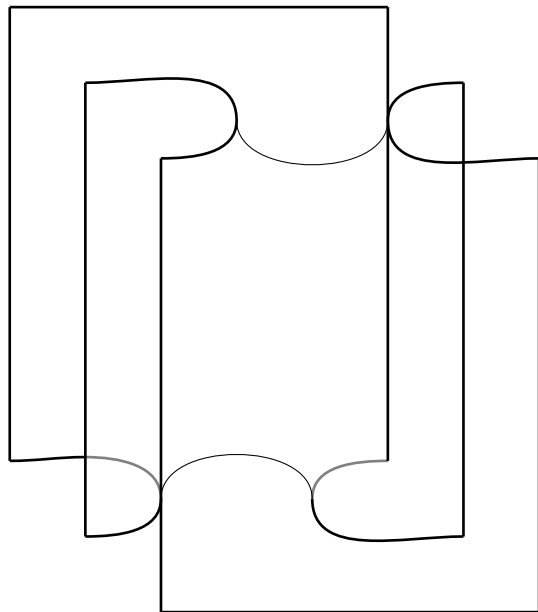



**Notation 4.2.1.42.** We denote the 2-arrow of 2-TL corresponding to the functor

$$\mathcal{S} \xrightarrow{r_0^{2\text{-TL}} \circ i_5^{F(\mathcal{S}), \text{twelve}} \circ \text{can}_{\mathcal{S}}} 2\text{-TL}^{\text{double}}$$

by  $\tau_5^{2,t}$ , and depict it as follows.

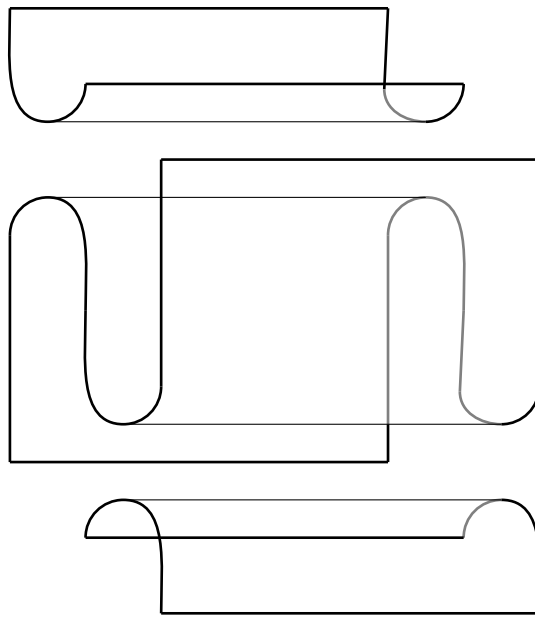

**Notation 4.2.1.43.** We denote the 2-arrow of 2-TL corresponding to the functor

$$\mathcal{S} \xrightarrow{r_0^{2\text{-TL}} \circ i_6^{F(\mathcal{S}), \text{twelve}} \circ \text{can}_{\mathcal{S}}} 2\text{-TL}^{\text{double}}$$

by  $\tau_6^{2,t}$ , and depict it as follows.

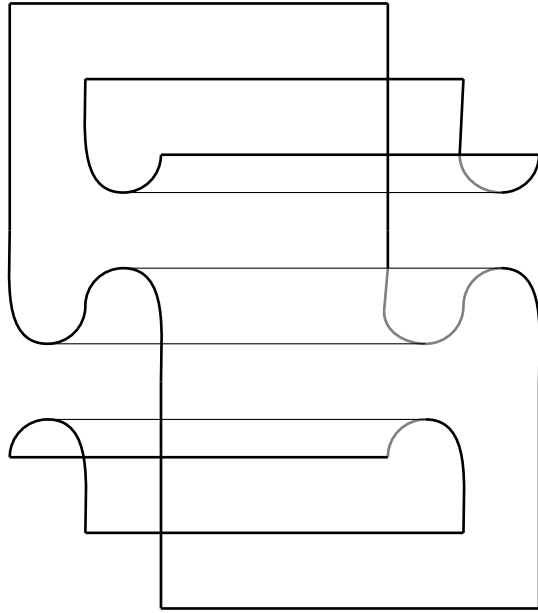

**Notation 4.2.1.44.** We denote the 2-arrow of 2-TL corresponding to the functor

$$\mathcal{S} \xrightarrow{r_0^{2\text{-TL}} \circ i_7^{\mathcal{F}(\mathcal{S}), \text{twelve}} \circ \text{can}_{\mathcal{S}}} 2\text{-TL}^{\text{double}}$$

by  $\tau_7^{2,t}$ , and depict it as follows.

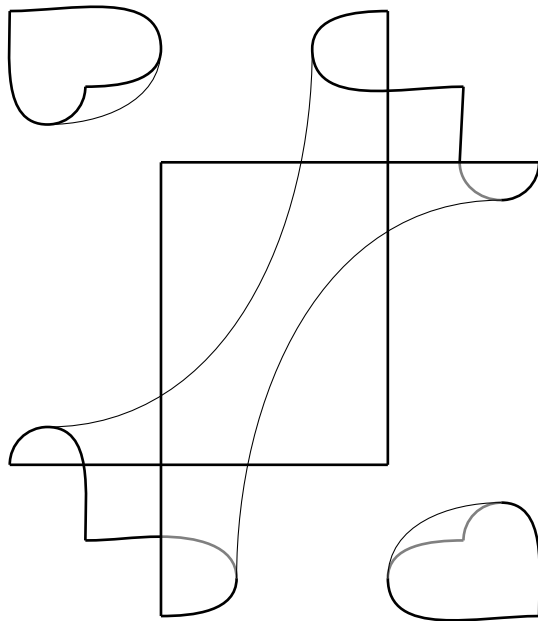

**Notation 4.2.1.45.** We denote the 2-arrow of 2-TL corresponding to the functor

$$\mathcal{S} \xrightarrow{r_0^{2\text{-TL}} \circ i_8^{F(\mathcal{S}), \text{twelve}} \circ \text{can}_{\mathcal{S}}} 2\text{-TL}^{\text{double}}$$

by  $\tau_8^{2,t}$ , and depict it as follows.

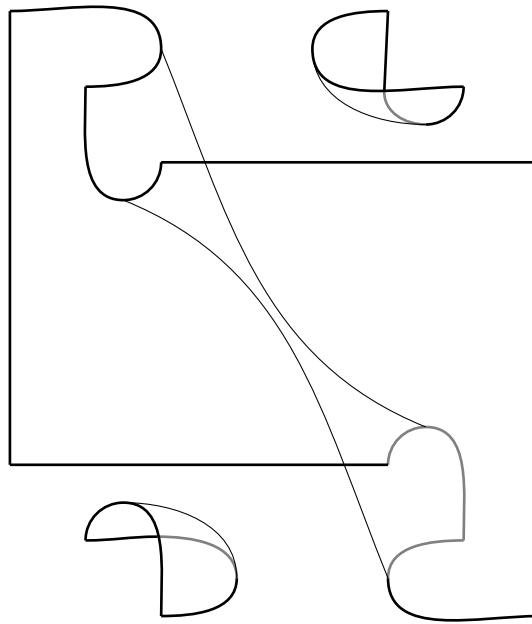

**Notation 4.2.1.46.** We denote the 2-arrow of 2-TL corresponding to the functor

$$\mathcal{S} \xrightarrow{r_0^{2\text{-TL}} \circ i_9^{F(\mathcal{S}), \text{twelve}} \circ \text{can}_{\mathcal{S}}} 2\text{-TL}^{\text{double}}$$

by  $\tau_9^{2,t}$ , and depict it as follows.

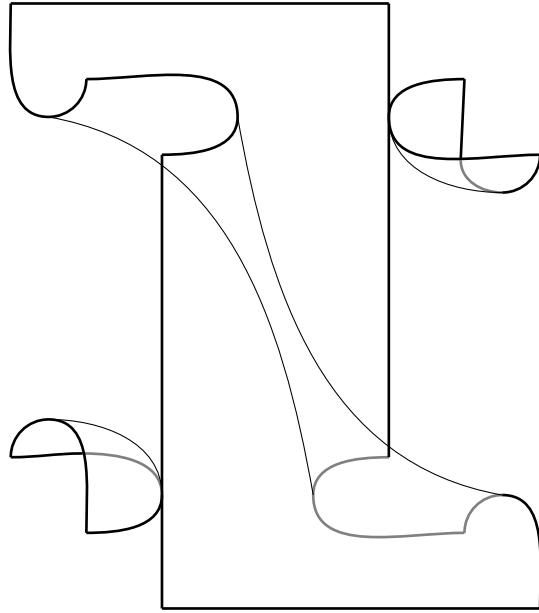

**Notation 4.2.1.47.** We denote the 2-arrow of 2-TL corresponding to the functor

$$\mathcal{S} \xrightarrow{r_0^{2\text{-TL}} \circ i_{10}^{F(\mathcal{S}), \text{twelve}} \circ \text{can}_{\mathcal{S}}} 2\text{-TL}^{\text{double}}$$

by  $\tau_{10}^{2;t}$ , and depict it as follows.

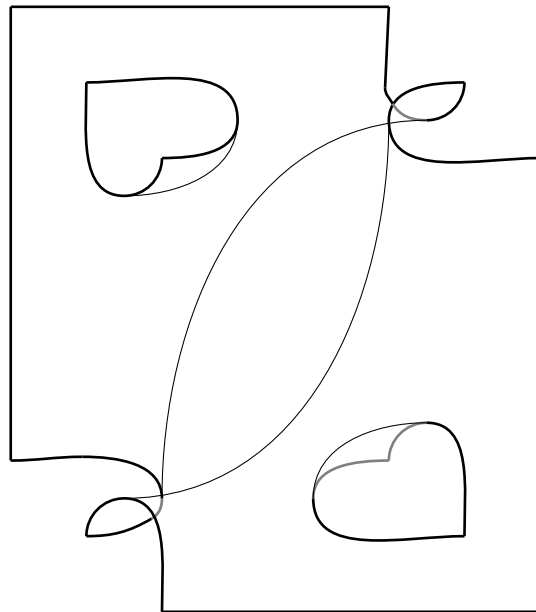

**Notation 4.2.1.48.** We denote the 2-arrow of 2-TL corresponding to the functor

$$\mathcal{S} \xrightarrow{r_0^{2\text{-TL}} \circ i_{11}^{F(\mathcal{S}), \text{twelve}} \circ \text{can}_{\mathcal{S}}} 2\text{-TL}^{\text{double}}$$

by  $\tau_{11}^{2,t}$ , and depict it as follows.

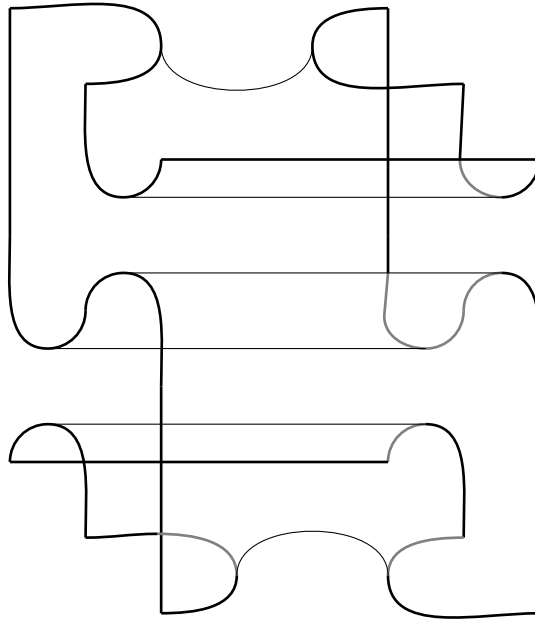

**Notation 4.2.1.49.** We denote the 2-arrow of 2-TL corresponding to the functor

$$\mathcal{S} \xrightarrow{r_0^{2\text{-TL}} \circ i_{12}^{F(\mathcal{S}), \text{twelve}} \circ \text{can}_{\mathcal{S}}} 2\text{-TL}^{\text{double}}$$

by  $\tau_{12}^{2,t}$ , and depict it as follows.

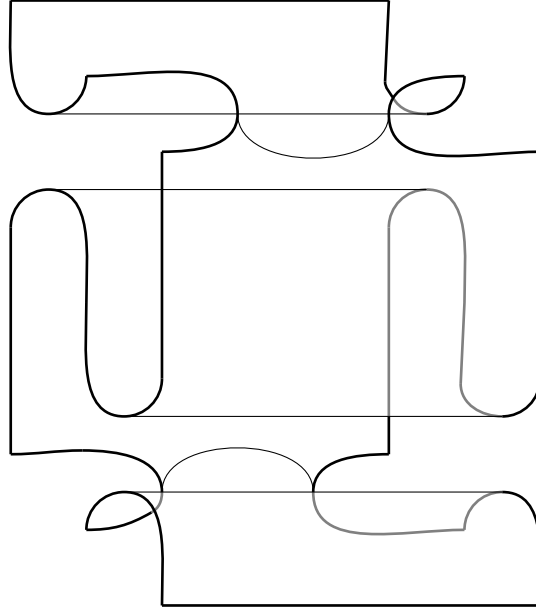

**Remark 4.2.1.50.** The underlying category of 2-TL is exactly TL. We shall, not, however, need this in our formal work, and omit a proof.

### 4.2.2. The Temperley-Lieb 2-category with respect to a datum for smoothing of 2-braids

**Definition 4.2.2.1.** A datum for smoothing of 2-braids consists of the following data.

- (1) A 3-ring  $\mathbb{R}$ . We shall also denote the cubical 2-category which is part of the data of  $\mathbb{R}$  by  $\mathbb{R}$ .
- (2) A pair  $A^1 = (A_0^1, A_1^1)$  of 1-arrows of  $\mathbb{R}$ .
- (3) A pair  $A^{2,d} = (A_1^{2,d}, A_2^{2,d})$  of 2-arrows  $\mathbb{R}$ .
- (4) An 8-tuple

$$A^{2,t} = (A_1^{2,t}, A_1^{2,t}, A_2^{2,t}, A_3^{2,t}, A_4^{2,t}, A_5^{2,t}, A_6^{2,t}, A_7^{2,t}, A_8^{2,t})$$

of 2-arrows of  $\mathbb{R}$ .

**Notation 4.2.2.2.** Throughout the remainder of this chapter, let  $\mathbb{S} = (\mathbb{R}, A^1, A^{2,d}, A^{2,t})$  be a datum for smoothing of 2-braids.

**Notation 4.2.2.3.** Appealing to Fact 2.1.3.16, let

$$\mathbb{R} \xrightarrow{i_1^{2\text{-TL}(\mathbb{S})^{\text{pre}}, bi}} 2\text{-TL}(\mathbb{S})^{\text{pre}} \xleftarrow{i_2^{2\text{-TL}(\mathbb{S})^{\text{pre}}, bi}} 2\text{-TL}$$

be a diagram in  $\text{Ring}(2\text{-Cat})$  which defines a binary coproduct.

**Terminology 4.2.2.4.** We refer to  $2\text{-TL}(\mathbb{S})^{\text{pre}}$  as the *pre-Temperley-Lieb cubical 2-category with respect to  $\mathbb{S}$* .

**Notation 4.2.2.5.** We denote the functor of 3-rings

$$2\text{-TL} \xrightarrow{i_2^{2\text{-TL}(\mathbb{S})^{\text{pre}}, bi}} 2\text{-TL}(\mathbb{S})^{\text{pre}}$$

by  $\text{can}_{2\text{-TL}(\mathbb{S})^{\text{pre}}}$ .

**Notation 4.2.2.6.** Let us denote the cubical 2-category which is part of the data of  $2\text{-TL}(\mathbb{S})^{\text{pre}}$  by  $2\text{-TL}(\mathbb{S})^{\text{pre}}$ .

**Notation 4.2.2.7.** Let

$$2\text{-TL}(\mathbb{S})^{\text{pre}} \xleftarrow{p_1^{2\text{-TL}(\mathbb{S})^{\text{pre}}, bi}} 2\text{-TL}(\mathbb{S})^{\text{pre}} \times 2\text{-TL}(\mathbb{S})^{\text{pre}} \xrightarrow{p_2^{2\text{-TL}(\mathbb{S})^{\text{pre}}, bi}} 2\text{-TL}(\mathbb{S})^{\text{pre}}$$

be the diagram in  $2\text{-Cat}$  which is part of the data of  $2\text{-TL}(\mathbb{S})^{\text{pre}}$ , which defines a binary product.

**Notation 4.2.2.8.** Appealing to Fact 2.2.2.2, let us denote the free 3-ring on  $\mathcal{S}$  by  $F_{3\text{-Ring}}(\mathcal{S})$ .

**Notation 4.2.2.9.** Let  $\sigma$  be a 2-arrow of  $2\text{-TL}$ . We then also denote by  $\sigma$  the canonical functor of 3-rings

$$F_{3\text{-Ring}}(\mathcal{S}) \longrightarrow \text{TL}(\mathbb{S})^{\text{pre}}$$

to which the functor

$$\mathcal{S} \xrightarrow{\sigma} 2\text{-TL}(\mathbb{S})^{\text{pre}}$$

gives rise by means of the universal property of  $F_{3\text{-Ring}}(\mathcal{S})$ .

**Notation 4.2.2.10.** Let  $\sigma$  and  $\tau$  be 2-arrows of  $2\text{-TL}$ . Let us denote by  $(\sigma, \tau)$  the canonical functor of 3-rings

$$F_{3\text{-Ring}}(\mathcal{S}) \longrightarrow 2\text{-TL}(\mathbb{S})^{\text{pre}} \times 2\text{-TL}(\mathbb{S})^{\text{pre}}$$

such that the following diagram in  $\text{Ring}(2\text{-Cat})$  commutes.

$$\begin{array}{ccccc}
& & F_{3\text{-Ring}}(\mathcal{S}) & & \\
& \swarrow & \downarrow & \searrow & \\
& i_1^{\text{TL}(\mathbb{S}), bi} \circ \sigma & (\sigma, \tau) & i_2^{\text{TL}(\mathbb{S}), bi} \circ \tau & \\
2\text{-TL}(\mathbb{S})^{\text{pre}} & \xleftarrow{p_1^{2\text{-TL}(\mathbb{S})^{\text{pre}}, bi}} & 2\text{-TL}(\mathbb{S})^{\text{pre}} \times 2\text{-TL}(\mathbb{S})^{\text{pre}} & \xrightarrow{p_2^{2\text{-TL}(\mathbb{S})^{\text{pre}}, bi}} & 2\text{-TL}(\mathbb{S})^{\text{pre}}
\end{array}$$

We denote by  $\sigma \otimes \tau$  the 2-arrow of  $2\text{-TL}(\mathbb{S})^{\text{pre}}$  corresponding to the functor

$$\mathcal{S} \xrightarrow{\otimes_{\text{TL}(\mathbb{S})} \circ (\sigma, \tau)} 2\text{-TL}(\mathbb{S})^{\text{pre}}.$$

**Remark 4.2.2.11.** In this way, we in particular have a notion of multiplication of 2-arrows of  $2\text{-TL}(\mathbb{S})^{\text{pre}}$ , thought of as formal sums of diagrammatic tangles, by  $A_1^{2,d}$ ,  $A_2^{2,d}$ , and  $A_j^{2,t}$  all  $1 \leq j \leq 8$ . This, for us, is the crucial difference between  $2\text{-TL}(\mathbb{S})^{\text{pre}}$  and  $2\text{-TL}$ .

**Notation 4.2.2.12.** Appealing to Fact 2.2.2.2, let us denote the free 3-ring on  $1_{2\text{-Cat}}$  by  $F_{3\text{-ring}}(1_{2\text{-Cat}})$ .

**Notation 4.2.2.13.** Let us denote by

$$F_{3\text{-ring}}(1_{2\text{-Cat}}) \xrightarrow{2} 2\text{-TL}(\mathbb{S})^{\text{pre}}$$

the canonical functor of 3-rings to which the functor

$$1_{2\text{-Cat}} \xrightarrow{i_2^{2\text{-TL}(\mathbb{S})^{\text{pre}}, bi} \circ 2} 2\text{-TL}(\mathbb{S})^{\text{pre}}$$

gives rise by means of the universal property of  $F_{3\text{-ring}}(1_{2\text{-Cat}})$ .

**Notation 4.2.2.14.** Let us denote the source and target of the arrow  $A$  of  $\mathbf{R}$  by  $a_0$  and  $a_1$  respectively, and the source and target of the arrow  $B$  of  $\mathbf{R}$  by  $b_0$  and  $b_1$  respectively.

**Notation 4.2.2.15.** Let us denote by

$$\partial\mathcal{I} \xrightarrow{((a_0 \otimes 2) \oplus (b_0 \otimes 2), (a_1 \otimes 2) \oplus (b_1 \otimes 2))} 2\text{-TL}(\mathbb{S})^{\text{pre}}$$

the functor determined by the objects  $(a_0 \otimes 2) \oplus (b_0 \otimes 2)$  and  $(a_1 \otimes 2) \oplus (b_1 \otimes 2)$  of  $2\text{-TL}(\mathbb{S})^{\text{pre}}$ .

**Notation 4.2.2.16.** Appealing to Fact 2.2.2.2, let us denote the free 3-ring on  $\partial\mathcal{I}$  by  $F_{3\text{-ring}}(\partial\mathcal{I})$ .

**Notation 4.2.2.17.** Let us denote by

$$F_{3\text{-ring}}(\partial\mathcal{I}) \xrightarrow{((a_0 \otimes 2) \oplus (b_0 \otimes 2), (a_1 \otimes 2) \oplus (b_1 \otimes 2))} 2\text{-TL}(\mathbb{S})^{\text{pre}}$$

the functor of 3-rings to which the functor

$$\partial\mathcal{I} \xrightarrow{((a_0 \otimes 2) \oplus (b_0 \otimes 2), (a_1 \otimes 2) \oplus (b_1 \otimes 2))} 2\text{-TL}(\mathbb{S})^{\text{pre}}$$

gives rise by means of the universal property of  $F_{3\text{-ring}}(\partial\mathcal{I})$ .



**Notation 4.2.2.18.** Appealing to Fact 2.1.3.16, let

$$\begin{array}{ccc} F_{3\text{-ring}}(\partial\mathcal{I}) & \xrightarrow{\quad} & 2\text{-TL}(\mathbb{S})^{\text{pre}} \xrightarrow{\text{can}_{2\text{-TL}(\mathbb{S})}} 2\text{-TL}(\mathbb{S}) \\ & \xrightarrow{(2,2)} & \end{array}$$

be a diagram, in which the unlabelled arrow is

$$F_{3\text{-ring}}(\partial\mathcal{I}) \xrightarrow{((a_0 \otimes 2) \oplus (b_0 \otimes 2), (a_1 \otimes 2) \oplus (b_1 \otimes 2))} 2\text{-TL}(\mathbb{S})^{\text{pre}},$$

in  $\text{Ring}(2\text{-Cat})$  which defines a coequaliser.

**Remark 4.2.2.19.** The idea of the construction of  $2\text{-TL}(\mathbb{S})$  from  $2\text{-TL}(\mathbb{S})^{\text{pre}}$  is that we identify both of the objects  $(a_0 \otimes 2) \oplus (b_0 \otimes 2)$  and  $(a_1 \otimes 2) \oplus (b_1 \otimes 2)$  of  $2\text{-TL}(\mathbb{S})^{\text{pre}}$  with the object  $2$  of  $2\text{-TL}(\mathbb{S})^{\text{pre}}$ . This ensures that certain arrows of  $2\text{-TL}(\mathbb{S})$  which we shall make crucial use of in §3.3 are endomorphisms of  $2$ , which we shall require in order to exhibit  $\mathbb{M}_{2\text{-Braids}^{\text{double}}}$  as a monoidal datum for  $2\text{-TL}(\mathbb{S})$ .

The objects and 1-arrows of  $2\text{-TL}(\mathbb{S})$  can be thought of in the same way as those of  $\text{TL}(\mathbb{S})$ . Because of the way in which we will make use of  $2\text{-TL}(\mathbb{S})$  in §3.3, we shall typically think of the 2-arrows of  $2\text{-TL}(\mathbb{S})$  as formal linear combinations of diagrammatic tangles, the coefficients of which are non-commutative polynomials in the variables  $A_1^{2,d}$ ,  $A_2^{2,d}$ , and  $A_j^{2,t}$  for  $1 \leq j \leq 8$ , built out of  $\oplus$  and  $\otimes$ . There are, though, many arrows of  $2\text{-TL}(\mathbb{S})$  which are not of this form.

### 4.2.3. Markov trace functors

**Definition 4.2.3.1.** Let  $\mathbb{R}$  be a 3-ring. A *Markov trace datum* with respect to  $\mathbb{R}$  consists of the following data.

- (1) A 3-ring  $\mathbb{T}$ .
- (2) A 1-arrow

$$1_{\mathbb{T}} \xrightarrow{\gamma} 1_{\mathbb{T}}$$

of  $\mathbb{T}$ .

- (3) A 4-tuple  $\Gamma_d = (\Gamma_{d,1}, \Gamma_{d,2}, \Gamma_{d,3}, \Gamma_{d,4})$  of 2-arrows of  $\mathbb{T}$  with the following boundaries.

$$\begin{array}{ccc} 1_{\mathbb{T}} & \xrightarrow{id} & 1_{\mathbb{T}} \\ id \downarrow & \Gamma_{d,1} & \downarrow \gamma \\ 1_{\mathbb{T}} & \xrightarrow{\gamma} & 1_{\mathbb{T}} \end{array}$$

of  $\mathbb{T}$ .

$$\begin{array}{ccc}
 1_{\mathbb{T}} & \xrightarrow{\gamma} & 1_{\mathbb{T}} \\
 id \downarrow & \Gamma_{d,2} & \downarrow \gamma \\
 1_{\mathbb{T}} & \xrightarrow{id} & 1_{\mathbb{T}}
 \end{array}$$

of  $\mathbb{T}$ .

$$\begin{array}{ccc}
 1_{\mathbb{T}} & \xrightarrow{id} & 1_{\mathbb{T}} \\
 \gamma \downarrow & \Gamma_{d,3} & \downarrow id \\
 1_{\mathbb{T}} & \xrightarrow{\gamma} & 1_{\mathbb{T}}
 \end{array}$$

of  $\mathbb{T}$ .

$$\begin{array}{ccc}
 1_{\mathbb{T}} & \xrightarrow{\gamma} & 1_{\mathbb{T}} \\
 \gamma \downarrow & \Gamma_{d,4} & \downarrow id \\
 1_{\mathbb{T}} & \xrightarrow{id} & 1_{\mathbb{T}}
 \end{array}$$

of  $\mathbb{T}$ .

- (3) A 4-tuple  $\Gamma_d = (\Gamma_{d,1}, \Gamma_{d,2}, \Gamma_{d,3}, \Gamma_{d,4})$  of 2-arrows of  $\mathbb{T}$  with the following boundaries.

$$\begin{array}{ccc}
 1_{\mathbb{T}} & \xrightarrow{id} & 1_{\mathbb{T}} \\
 id \downarrow & \Gamma_{d,1} & \downarrow \gamma \\
 1_{\mathbb{T}} & \xrightarrow{\gamma} & 1_{\mathbb{T}}
 \end{array}$$

of  $\mathbb{T}$ .

$$\begin{array}{ccc}
1_{\mathbb{T}} & \xrightarrow{\gamma} & 1_{\mathbb{T}} \\
id \downarrow & \Gamma_{d,2} & \downarrow \gamma \\
1_{\mathbb{T}} & \xrightarrow{id} & 1_{\mathbb{T}}
\end{array}$$

of  $\mathbb{T}$ .

$$\begin{array}{ccc}
1_{\mathbb{T}} & \xrightarrow{id} & 1_{\mathbb{T}} \\
\gamma \downarrow & \Gamma_{d,3} & \downarrow id \\
1_{\mathbb{T}} & \xrightarrow{\gamma} & 1_{\mathbb{T}}
\end{array}$$

of  $\mathbb{T}$ .

$$\begin{array}{ccc}
1_{\mathbb{T}} & \xrightarrow{\gamma} & 1_{\mathbb{T}} \\
\gamma \downarrow & \Gamma_{d,4} & \downarrow id \\
1_{\mathbb{T}} & \xrightarrow{id} & 1_{\mathbb{T}}
\end{array}$$

of  $\mathbb{T}$ .

(4) A 12-tuple  $\Gamma_t = (\Gamma_{t,1}, \dots, \Gamma_{t,12})$  of 2-arrows of  $\mathbb{T}$  with the following boundaries.

$$\begin{array}{ccc}
1_{\mathbb{T}} & \xrightarrow{id} & 1_{\mathbb{T}} \\
\gamma \downarrow & \Gamma_{t,1} & \downarrow \gamma \\
1_{\mathbb{T}} & \xrightarrow{id} & 1_{\mathbb{T}}
\end{array}$$

of  $\mathbb{T}$ .

$$\begin{array}{ccc}
1_{\mathbb{T}} & \xrightarrow{id} & 1_{\mathbb{T}} \\
\gamma \downarrow & \Gamma_{t,2} & \downarrow \gamma \\
1_{\mathbb{T}} & \xrightarrow{id} & 1_{\mathbb{T}}
\end{array}$$

of  $\mathbb{T}$ .

$$\begin{array}{ccc} 1_{\mathbb{T}} & \xrightarrow{\gamma} & 1_{\mathbb{T}} \\ id \downarrow & \Gamma_{t,3} & \downarrow id \\ 1_{\mathbb{T}} & \xrightarrow{\gamma} & 1_{\mathbb{T}} \end{array}$$

of  $\mathbb{T}$ .

$$\begin{array}{ccc} 1_{\mathbb{T}} & \xrightarrow{\gamma} & 1_{\mathbb{T}} \\ id \downarrow & \Gamma_{t,4} & \downarrow id \\ 1_{\mathbb{T}} & \xrightarrow{\gamma} & 1_{\mathbb{T}} \end{array}$$

of  $\mathbb{T}$ .

$$\begin{array}{ccc} 1_{\mathbb{T}} & \xrightarrow{id} & 1_{\mathbb{T}} \\ \gamma \circ \gamma \downarrow & \Gamma_{t,5} & \downarrow \gamma \circ \gamma \\ 1_{\mathbb{T}} & \xrightarrow{id} & 1_{\mathbb{T}} \end{array}$$

of  $\mathbb{T}$ .

$$\begin{array}{ccc} id & \xrightarrow{id} & 1_{\mathbb{T}} \\ \gamma \circ \gamma \downarrow & \Gamma_{t,6} & \downarrow \gamma \circ \gamma \\ 1_{\mathbb{T}} & \xrightarrow{id} & 1_{\mathbb{T}} \end{array}$$

of  $\mathbb{T}$ .

$$\begin{array}{ccc} 1_{\mathbb{T}} & \xrightarrow{\gamma} & 1_{\mathbb{T}} \\ \gamma \downarrow & \Gamma_{t,7} & \downarrow \gamma \\ 1_{\mathbb{T}} & \xrightarrow{\gamma} & 1_{\mathbb{T}} \end{array}$$

of  $\mathbb{T}$ .

$$\begin{array}{ccc} 1_{\mathbb{T}} & \xrightarrow{\gamma} & 1_{\mathbb{T}} \\ \gamma \downarrow & \Gamma_{t,8} & \downarrow \gamma \\ 1_{\mathbb{T}} & \xrightarrow{\gamma} & 1_{\mathbb{T}} \end{array}$$

of  $\mathbb{T}$ .

$$\begin{array}{ccc} 1_{\mathbb{T}} & \xrightarrow{\gamma} & 1_{\mathbb{T}} \\ \gamma \downarrow & \Gamma_{t,9} & \downarrow \gamma \\ 1_{\mathbb{T}} & \xrightarrow{\gamma} & 1_{\mathbb{T}} \end{array}$$

of  $\mathbb{T}$ .

$$\begin{array}{ccc} 1_{\mathbb{T}} & \xrightarrow{\gamma} & 1_{\mathbb{T}} \\ \gamma \downarrow & \Gamma_{t,10} & \downarrow \gamma \\ 1_{\mathbb{T}} & \xrightarrow{\gamma} & 1_{\mathbb{T}} \end{array}$$

of  $\mathbb{T}$ .

$$\begin{array}{ccc} 1_{\mathbb{T}} & \xrightarrow{\gamma} & 1_{\mathbb{T}} \\ \gamma \circ \gamma \downarrow & \Gamma_{t,11} & \downarrow \gamma \circ \gamma \\ 1_{\mathbb{T}} & \xrightarrow{\gamma} & 1_{\mathbb{T}} \end{array}$$

of  $\mathbb{T}$ .

$$\begin{array}{ccc} 1_{\mathbb{T}} & \xrightarrow{\gamma} & 1_{\mathbb{T}} \\ \gamma \circ \gamma \downarrow & \Gamma_{t,12} & \downarrow \gamma \circ \gamma \\ 1_{\mathbb{T}} & \xrightarrow{\gamma} & 1_{\mathbb{T}} \end{array}$$

of  $\mathbb{T}$ .

(5) A 2-arrow

$$\begin{array}{ccc}
 1_{\mathbb{T}} & \xrightarrow{id} & 1_{\mathbb{T}} \\
 id \downarrow & \Gamma & \downarrow id \\
 1_{\mathbb{T}} & \xrightarrow{id} & 1_{\mathbb{T}}
 \end{array}$$

of  $\mathbb{T}$ .

**Notation 4.2.3.2.** Until further notice, let  $\mathbb{R}$  be a 3-ring, and let  $\mathbb{T} = (\mathbb{T}^{\text{pre-sph}}, \gamma, \Gamma_d, \Gamma_t, \Gamma)$  be a Markov trace datum with respect to  $\mathbb{R}$ .

**Notation 4.2.3.3.** Let

$$\bigsqcup_4 \mathcal{S} \xrightarrow{\bigsqcup \text{Tr}} \mathbb{T}^{\text{pre-sph}}$$

denote the canonical functor such that the following diagram in 2-Cat commutes for every  $1 \leq j \leq 12$ .

$$\begin{array}{ccc}
 \mathcal{S} & \xrightarrow{i_1^{\mathcal{S}, \text{four}}} & \bigsqcup_4 \mathcal{S} \\
 \Gamma_{d,j} \searrow & & \downarrow \bigsqcup_4 \text{Tr} \\
 & & \mathbb{T}^{\text{pre-sph}}
 \end{array}$$

**Proposition 4.2.3.4.** *The following diagram in 2-Cat commutes.*

$$\begin{array}{ccc}
 \bigsqcup_4 \partial \mathcal{S} & \xrightarrow{\bigsqcup_4 \iota} & \bigsqcup_4 \mathcal{S} \\
 \bigsqcup_4 \text{generators} \downarrow & & \downarrow \bigsqcup_4 \text{Tr} \\
 \text{TL}_{\leq 2} & \xrightarrow{\text{Tr}_{\leq 2}} & \mathbb{T}^{\text{pre-sph}}
 \end{array}$$

*Proof.*

□

**Notation 4.2.3.5.** Appealing to Proposition 4.2.3.4, let us denote by

$$2\text{-TL}_{\leq 2}^{\text{double}} \xrightarrow{\text{Tr}_{\leq 2}} \mathbb{T}$$

the canonical functor such that the following diagram in 2-Cat commutes.

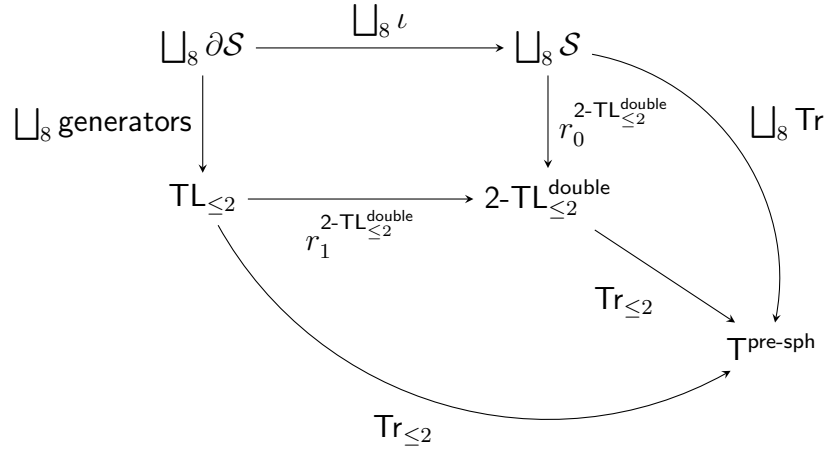

**Proposition 4.2.3.6.** *The following diagram in 2-Cat commutes.*

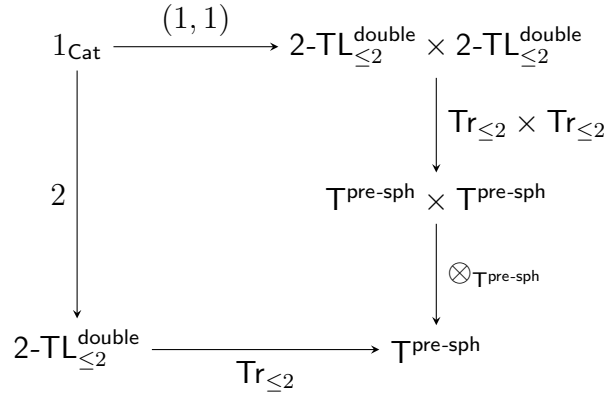

**Corollary 4.2.3.7.** *The functor*

$$2\text{-TL}_{\leq 2}^{\text{double}} \xrightarrow{\text{Tr}_{\leq 2}} \mathbb{T}^{\text{pre-sph}}$$

*exhibits  $\mathbb{M}_{2\text{-TL}^{\text{double}}}$  as a monoidal datum for  $\mathbb{T}^{\text{pre-sph}}$ .*

**Notation 4.2.3.8.** Appealing to Corollary 4.2.3.7, let

$$2\text{-TL}^{\text{double}} \xrightarrow{\text{Tr}} \mathbb{T}^{\text{pre-sph}}$$

denote the canonical functor of 3-rings to which the functor

$$2\text{-TL}_{\leq 2}^{\text{double}} \xrightarrow{\text{Tr}_{\leq 2}} \mathbb{T}^{\text{pre-sph}}$$

gives rise, by means of the universal property of  $2\text{-TL}^{\text{double}}$ .

**Notation 4.2.3.9.** Appealing to Fact 2.2.2, let us denote by  $F_{3\text{-ring}}(\mathcal{S})$  the free 3-ring on  $\mathcal{S}$ . Let us denote the canonical functor

$$\mathcal{S} \longrightarrow F_{3\text{-ring}}(\mathcal{S})$$

by  $\text{can}_{F_{3\text{-ring}}}(\mathcal{S})$ .

**Notation 4.2.3.10.** Let

$$\begin{array}{ccc} \mathcal{S} & \cdots & \mathcal{S} \\ & \searrow & \swarrow \\ & \bigsqcup_{12} F_{3\text{-ring}}(\mathcal{S}) & \end{array}$$

$\iota_1^{F_{3\text{-ring}}(\mathcal{S}), \text{twelve}}$        $\iota_{12}^{F_{3\text{-ring}}(\mathcal{S}), \text{twelve}}$

be a diagram in  $\text{Ring}(2\text{-Cat})$  which defines a coproduct of twelve copies of  $F_{3\text{-ring}}(\mathcal{S})$ .

**Notation 4.2.3.11.** Let

$$\bigsqcup_{12} F_{3\text{-ring}}(\mathcal{S}) \xrightarrow{\bigsqcup_{12} \text{Tr}} \mathbb{T}^{\text{pre-sph}}$$

denote the canonical functor of 3-rings such that the following diagram in  $2\text{-Cat}$  commutes for every  $1 \leq j \leq 12$ .

$$\begin{array}{ccc} F_{3\text{-ring}}(\mathcal{S}) & \xrightarrow{\iota_j^{F_{3\text{-ring}}(\mathcal{S}), \text{twelve}}} & \bigsqcup_{12} F_{3\text{-ring}}(\mathcal{S}) \\ & \searrow \Gamma_{t,j} & \downarrow \bigsqcup_{12} \text{Tr} \\ & & \mathbb{T}^{\text{pre-sph}} \end{array}$$

**Proposition 4.2.3.12.** *The following diagram in  $\text{Ring}(\text{Cat})$  commutes.*

$$\begin{array}{ccc} \bigsqcup_{12} F(\partial\mathcal{S}) & \xrightarrow{\bigsqcup_{12} \iota} & \bigsqcup_{12} F(\mathcal{S}) \\ \bigsqcup \text{generators} \downarrow & & \downarrow \bigsqcup_{12} \text{Tr} \\ 2\text{-TL}^{\text{double}} & \xrightarrow{\text{Tr}} & \mathbb{T} \end{array}$$

**Notation 4.2.3.13.** Appealing to Proposition 4.2.3.12, let

$$2\text{-TL} \xrightarrow{\text{Tr}} \mathbb{T}^{\text{pre-sph}}$$



denote the canonical functor of 3-rings such that the following diagram in  $\text{Ring}(2\text{-Cat})$  commutes.

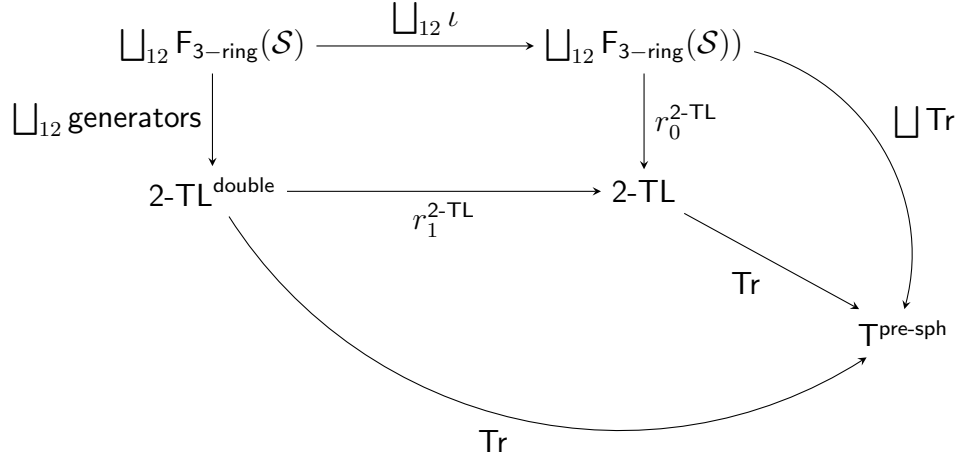

**Notation 4.2.3.14.** Let

$$2\text{-TL}(\mathcal{S})^{\text{pre}} \xrightarrow{\text{Tr}^{\mathcal{S}, \text{pre-sph}}} \mathbb{T}^{\text{pre-sph}}$$

denote the canonical functor of 3-rings such that the following diagram in  $\text{Ring}(2\text{-Cat})$  commutes.

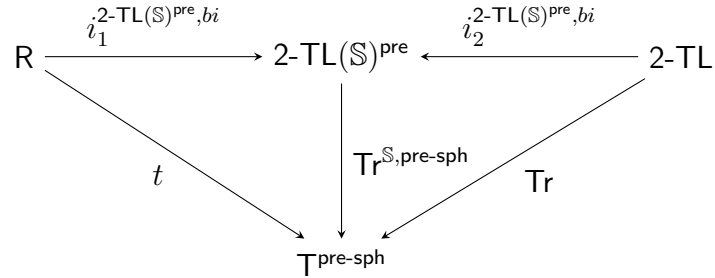

**Terminology 4.2.3.15.** We refer to

$$2\text{-TL}(\mathcal{S})^{\text{pre}} \xrightarrow{\text{Tr}^{\mathcal{S}, \text{pre-sph}}} \mathbb{T}^{\text{pre-sph}}$$

as the *pre-spherical Markov trace functor* associated to  $\mathbb{T}$ .

**Notation 4.2.3.16.** For every  $1 \leq j \leq 4$ , let

$$\mathcal{F}_{3\text{-ring}}(\mathcal{S}) \xrightarrow{\Gamma_{d,j}} \mathbb{T}^{\text{pre-sph}}$$

denote the functor of 3-rings to which the functor

$$\mathcal{S} \xrightarrow{\Gamma_{d,j} \circ \iota} \mathbb{T}^{\text{pre-sph}}$$

gives rise, by means of the universal property of  $F_{3\text{-ring}}(\mathcal{S})$ .

**Notation 4.2.3.17.** For every  $1 \leq j \leq 12$ , let

$$F_{3\text{-ring}}(\mathcal{S}) \xrightarrow{\Gamma_{t,j}} \mathbb{T}^{\text{pre-sph}}$$

denote the functor of 3-rings to which the functor

$$\mathcal{S} \xrightarrow{\Gamma_{t,j} \circ \iota} \mathbb{T}^{\text{pre-sph}}$$

gives rise, by means of the universal property of  $F_{3\text{-ring}}(\mathcal{S})$ .

**Notation 4.2.3.18.** Let

$$\begin{array}{ccc} F_{3\text{-ring}}(\mathcal{S}) & \cdots & F_{3\text{-ring}}(\mathcal{S}) \\ & \searrow & \swarrow \\ & \bigsqcup_{16} F_{3\text{-ring}}(\mathcal{S}) & \end{array}$$

$i_1^{F_{3\text{-ring}}(\mathcal{S}),16}$        $i_{16}^{\mathcal{S},16}$

be a diagram in  $\text{Ring}(2\text{-Cat})$  which defines a coproduct of 16 copies of  $F_{3\text{-ring}}(\mathcal{S})$ .

**Notation 4.2.3.19.** Let

$$\bigsqcup_{12} F_{3\text{-ring}}(\mathcal{S}) \xrightarrow{\bigsqcup_{16} \partial} \mathbb{T}^{\text{pre-sph}}$$

denote the canonical functor of 3-rings such that the diagram

$$\begin{array}{ccc} F_{3\text{-ring}}(\mathcal{S}) & \xrightarrow{i_j^{F_{3\text{-ring}}(\mathcal{S}),16}} & \bigsqcup_{16} F_{3\text{-ring}}(\mathcal{S}) \\ & \searrow \Gamma_{d,j} & \downarrow \bigsqcup_{16} \partial \\ & & \mathbb{T}^{\text{pre-sph}} \end{array}$$

in  $2\text{-Cat}$  commutes for every  $1 \leq j \leq 4$ , and the diagram

$$\begin{array}{ccc} F_{3\text{-ring}}(\mathcal{S}) & \xrightarrow{i_j^{F_{3\text{-ring}}(\mathcal{S}),16}} & \bigsqcup_{16} F_{3\text{-ring}}(\mathcal{S}) \\ & \searrow \Gamma_{t,j-4} & \downarrow \bigsqcup_{16} \partial \\ & & \mathbb{T}^{\text{pre-sph}} \end{array}$$

in  $2\text{-Cat}$  commutes for every  $5 \leq j \leq 16$ .

**Notation 4.2.3.20.** Let us denote by

$$\bigsqcup_{16} \mathbf{F}_{3\text{-ring}}(\mathcal{S}) \xrightarrow{\nabla} \mathbf{F}_{3\text{-ring}}(\mathcal{S})$$

the canonical functor of 3-rings such that the following diagram in  $\text{Ring}(2\text{-Cat})$  commutes for every  $1 \leq j \leq 16$ .

$$\begin{array}{ccc} \mathbf{F}_{3\text{-ring}}(\mathcal{S}) & \xrightarrow{i_j^{\mathbf{F}_{3\text{-ring}}(\mathcal{S}),16}} & \bigsqcup_{16} \mathbf{F}_{3\text{-ring}}(\mathcal{S}) \\ & \searrow id & \downarrow \nabla \\ & & \mathbb{T}^{\text{pre-sph}} \end{array}$$

**Notation 4.2.3.21.** Let us denote by

$$\bigsqcup_{16} \mathbf{F}_{3\text{-ring}}(\mathcal{S}) \xrightarrow{\Gamma} \mathbb{T}^{\text{pre-sph}}$$

the canonical functor of 3-rings to which the functor

$$\mathcal{S} \xrightarrow{\Gamma} \mathbb{T}^{\text{pre-sph}}$$

gives rise.

**Notation 4.2.3.22.** Appealing to Fact 2.1.3.16, let

$$\begin{array}{ccccc} \bigsqcup_{16} \mathbf{F}_{3\text{-ring}}(\mathcal{S}) & \xrightarrow{\bigsqcup_{16} \partial} & \mathbb{T}^{\text{pre-sph}} & \xrightarrow{\text{can}_{\mathbb{T}^{\text{pre}}}} & \mathbb{T}^{\text{pre}} \\ & \xrightarrow{\Gamma \circ \nabla} & & & \end{array}$$

be a diagram in  $\text{Ring}(2\text{-Cat})$  which defines a coequaliser.

**Notation 4.2.3.23.** Let us denote by

$$2\text{-TL}(\mathbb{S})^{\text{pre}} \xrightarrow{\text{Tr}^{\mathbb{S},\text{pre}}} \mathbb{T}^{\text{pre}}$$

the functor of 3-rings given by  $\text{can}_{\mathbb{T}^{\text{pre}}} \circ \mathbb{T}^{\text{pre-sph}}$ .

**Terminology 4.2.3.24.** We refer to  $\mathbb{T}^{\text{pre}}$  as the *pre-Markov trace functor* with respect to  $\mathbb{T}$ .

**Notation 4.2.3.25.** Appealing to Fact 2.2.2.2, let us denote the free 3-ring on  $1_{2\text{-Cat}}$  by  $\mathbf{F}_{3\text{-Ring}}(1_{2\text{-Cat}})$ .

**Notation 4.2.3.26.** Let us denote by

$$F_{3\text{-ring}}(1_{2\text{-Cat}}) \xrightarrow{1_{\mathbb{T}^{\text{pre}}}} \mathbb{T}^{\text{pre}}$$

the canonical functor of 3-rings to which the functor

$$1_{2\text{-Cat}} \xrightarrow{1_{\mathbb{T}^{\text{pre}}}} \mathbb{T}^{\text{pre}}$$

gives rise, by means of the universal property of  $F_{3\text{-ring}}(1_{2\text{-Cat}})$ .

**Notation 4.2.3.27.** Let us denote by

$$\partial\mathcal{I} \xrightarrow{\text{Tr}^{\mathbb{S},\text{pre}}(a_0 \oplus b_0) \sqcup \text{Tr}^{\mathbb{S},\text{pre}}(a_1 \oplus b_1)} \mathbb{T}^{\text{pre}}$$

the canonical functor determined by the pair of objects  $\text{Tr}^{\mathbb{S},\text{pre}}(a_0 \oplus b_0)$  and  $\text{Tr}^{\mathbb{S},\text{pre}}(a_1 \oplus b_1)$  of  $\mathbb{T}^{\text{pre}}$ .

**Notation 4.2.3.28.** Appealing to Fact 2.2.2.2, let us denote the free 3-ring on  $1_{\partial\mathcal{I}}$  by  $F_{3\text{-Ring}}(\partial\mathcal{I})$ .

**Notation 4.2.3.29.** Let us denote by

$$F_{3\text{-ring}}(\partial\mathcal{I}) \xrightarrow{\text{Tr}^{\mathbb{S},\text{pre}}(a_0 \oplus b_0) \sqcup \text{Tr}^{\mathbb{S},\text{pre}}(a_1 \oplus b_1)} \mathbb{T}^{\text{pre}}$$

the canonical functor of 3-rings to which the functor

$$\partial\mathcal{I} \xrightarrow{\text{Tr}^{\mathbb{S},\text{pre}}(a_0 \oplus b_0) \sqcup \text{Tr}^{\mathbb{S},\text{pre}}(a_1 \oplus b_1)} \mathbb{T}^{\text{pre}}$$

gives rise by means of the universal property of  $F_{3\text{-ring}}(\partial\mathcal{I})$ .

**Notation 4.2.3.30.** Let us denote by

$$\partial\mathcal{I} \xrightarrow{(1_{\mathbb{T}^{\text{pre}}}, 1_{\mathbb{T}^{\text{pre}}})} \mathbb{T}^{\text{pre}}$$

the functor determined by the pair  $(1_{\mathbb{T}^{\text{pre}}}, 1_{\mathbb{T}^{\text{pre}}})$  of objects of  $\mathbb{T}^{\text{pre}}$ .

**Notation 4.2.3.31.** Let us denote by

$$F_{3\text{-ring}}(\partial\mathcal{I}) \xrightarrow{(1_{\mathbb{T}^{\text{pre}}}, 1_{\mathbb{T}^{\text{pre}}})} \mathbb{T}^{\text{pre}}$$

the canonical functor of 3-rings to which the functor

$$\partial\mathcal{I} \xrightarrow{(1_{\mathbb{T}^{\text{pre}}}, 1_{\mathbb{T}^{\text{pre}}})} \mathbb{T}^{\text{pre}}$$

gives rise by means of the universal property of  $F_{3\text{-ring}}(\partial\mathcal{I})$ .

**Notation 4.2.3.32.** Appealing to Fact 2.1.3.16, let

$$F_{3\text{-ring}}(\partial\mathcal{I}) \begin{array}{c} \xrightarrow{\text{Tr}^{\mathbb{S},\text{pre}}(a_0 \oplus b_0) \sqcup \text{Tr}^{\mathbb{S},\text{pre}}(a_1 \oplus b_1)} \\ \xrightarrow{(1_{\mathbb{T}^{\text{pre}}}, 1_{\mathbb{T}^{\text{pre}}})} \end{array} \mathbb{T}^{\text{pre}} \xrightarrow{\text{can}_{\mathbb{T}}} \mathbb{T}$$

be a coequaliser diagram in  $\text{Ring}(2\text{-Cat})$ .

**Remark 4.2.3.33.** The idea of the construction of  $\mathbb{T}$  from  $\mathbb{T}^{\text{pre}}$  is that we identify both of the objects  $\text{Tr}^{\mathbb{S},\text{pre}}(a_0 \oplus a_1)$  and  $\text{Tr}^{\mathbb{S},\text{pre}}(b_0 \oplus b_1)$  of  $\mathbb{T}^{\text{pre}}$  with the object  $1_{\mathbb{T}^{\text{pre}}}$  of  $\mathbb{T}^{\text{pre}}$ . The purpose of this is to ensure that the functor of 3-rings

$$2\text{-TL}(\mathbb{S})^{\text{pre}} \xrightarrow{\text{Tr}^{\mathbb{S},\text{pre}}} \mathbb{T}^{\text{pre}}$$

extends to a functor from

$$2\text{-TL}(\mathbb{S}) \longrightarrow \mathbb{T},$$

in the manner we shall now describe.

**Proposition 4.2.3.34.** *The following diagram in  $2\text{-Cat}$  commutes.*

$$\begin{array}{ccc} 1_{2\text{-Cat}} & \xrightarrow{(a_0 \otimes 2) \oplus (b_0 \otimes 2)} & 2\text{-TL}(\mathbb{S})^{\text{pre}} \\ \downarrow 2 & & \downarrow \text{can}_{\mathbb{T}} \circ \text{Tr}^{\mathbb{S},\text{pre}} \\ 2\text{-TL}(\mathbb{S})^{\text{pre}} & \xrightarrow{\text{can}_{\mathbb{T}} \circ \text{Tr}^{\mathbb{S},\text{pre}}} & \mathbb{T} \end{array}$$

**Proposition 4.2.3.35.** *The following diagram in  $2\text{-Cat}$  commutes.*

$$\begin{array}{ccc} 1_{2\text{-Cat}} & \xrightarrow{(a_1 \otimes 2) \oplus (b_1 \otimes 2)} & 2\text{-TL}(\mathbb{S})^{\text{pre}} \\ \downarrow 2 & & \downarrow \text{can}_{\mathbb{T}} \circ \text{Tr}^{\mathbb{S},\text{pre}} \\ 2\text{-TL}(\mathbb{S})^{\text{pre}} & \xrightarrow{\text{can}_{\mathbb{T}} \circ \text{Tr}^{\mathbb{S},\text{pre}}} & \mathbb{T} \end{array}$$

*Proof.* Entirely analogous to the proof of Proposition 4.2.3.34. □

**Corollary 4.2.3.36.** *The following diagram in  $\text{Ring}(2\text{-Cat})$  commutes.*

$$\begin{array}{ccc}
F_{3\text{-ring}}(\partial\mathcal{I}) & \xrightarrow{((a_0 \otimes 2) \oplus (b_0 \otimes 2)) \sqcup ((a_1 \otimes 2) \oplus (b_1 \otimes 2))} & 2\text{-TL}(\mathbb{S})^{\text{pre}} \\
(2, 2) \downarrow & & \downarrow \text{can}_{\mathbb{T}} \circ \text{Tr}^{\mathbb{S}, \text{pre}} \\
2\text{-TL}(\mathbb{S})^{\text{pre}} & \xrightarrow{\text{can}_{\mathbb{T}} \circ \text{Tr}^{\mathbb{S}, \text{pre}}} & \mathbb{T}
\end{array}$$

**Notation 4.2.3.37.** Appealing to Corollary 4.2.3.36, let

$$2\text{-TL}(\mathbb{S}) \xrightarrow{\text{Tr}^{\mathbb{S}}} \mathbb{T}$$

denote the canonical functor of 3-rings such that the following diagram in  $\text{Ring}(\text{Cat})$  commutes.

$$\begin{array}{ccc}
2\text{-TL}(\mathbb{S})^{\text{pre}} & \xrightarrow{\text{can}_{2\text{-TL}(\mathbb{S})}} & 2\text{-TL}(\mathbb{S}) \\
& \searrow \text{Tr}^{\mathbb{S}, \text{pre}} & \downarrow \text{Tr}^{\mathbb{S}} \\
& & \mathbb{T}
\end{array}$$

**Terminology 4.2.3.38.** We refer to  $\text{Tr}^{\mathbb{S}}$  as the *Markov trace functor* with respect to  $\mathbb{T}$ .

**Remark 4.2.3.39.** The Markov trace functor

$$2\text{-TL}(\mathbb{S}) \xrightarrow{\text{Tr}^{\mathbb{S}}} \mathbb{T}$$

does *not* agree with the Markov trace functor

$$\text{TL}(\mathbb{S}) \xrightarrow{\text{Tr}^{\mathbb{S}}} \mathbb{T}$$

on 1-arrows. The origin of this is in the passage from  $\mathbb{T}^{\text{pre-sph}}$  to  $\mathbb{T}^{\text{pre}}$ , which has as a consequence that  $\gamma$  is forced to become equal to  $id(1_{\mathbb{T}^{\text{pre}}})$ .

### 4.3. The Kauffman 2-bracket invariant

Given a datum  $\mathbb{S}$  for smoothing of 2-braids, we construct in a canonical way a strict monoidal functor **Smoothing** from **2-Braids** to  $2\text{-TL}(\mathbb{S})$  which, on arrows, we think of as ‘smoothing’ a 2-braid to a formal linear sum of diagrammatic 2-tangles, categorifying the smoothing functor which we constructed in §3.3. The construction of this functor, and in particular the way in which we define smoothing of triple plane crossings, is perhaps the heart of this thesis.

Our notion of smoothing of triple plane crossings is motivated entirely by topological considerations. To smoothen a triple plane crossing, we choose, for each of three pairs of planes involved, one of the two ways to smoothen their double plane crossing. We then fit the pieces of planes which we obtain together in a compatible way. Each triple plane crossing has, in this way eight smoothings, rather than the two which we have for a double plane crossing, or a crossing in the ordinary theory of braids. However, the triple plane crossings do not give rise to the same smoothings. There are in fact twelve possibilities, altogether.

Since each triple plane crossing gives rise to eight smoothings, we require eight variables,  $A_1^{2,t}, \dots, A_8^{2,t}$  to keep track of them. We do so as follows. The choice of smoothing for each of the pairs of crossings in the triple plane crossing can be kept track of by a triple, each of entry of which is either  $A_1^{2,d}$  or  $A_2^{2,d}$ . We then simply pick one way to assign the variables  $A_1^{2,t}, \dots, A_8^{2,t}$  to the eight possible such triples.

Given a Markov trace datum  $\mathbb{T}$ , we combine our smoothing functor with the Markov trace functor with respect to  $\mathbb{T}$  constructed in §??, to define a strict monoidal functor from **2-Braids** to a 3-ring  $\mathbb{T}$  which is constructed from the data of  $\mathbb{T}$ . On 2-arrows, we think of this functor as categorifying the Kauffman bracket functor which we constructed in §3.3. We then demonstrate how this strict monoidal functor gives rise to a functor from **Braids/R-moves** to  $\mathbb{T}$ . On 2-arrows, we think of the construction of last functor as a demonstration that we have constructed an invariant of 2-braids.

There is much which remains to be explored regarding our Kauffman 2-bracket invariant. We have not had the opportunity yet to investigate its efficacy in detecting interesting 2-braids which are not isotopic to trivial 2-braids. In particular, we are very interested in using our invariant to detect 2-knottedness. However, considerable work is first required to relate our 2-braid theory to 2-knot theory. There should be a way to ‘close up’ our 2-braids to 2-knots, but this is a more subtle matter than in ordinary braid and knot theory. In particular, it will almost certainly be necessary to impose some restrictions on the possible boundaries of those 2-braids for which we define ‘closing up’. Having now established a theoretical framework for a Kauffman 2-bracket invariant, which we believe to be robust, we plan in future work to explore and refine it through calculating it for examples of 2-braids, once we understand better how to obtain how to characterise such examples.

On a different note, we conjecture that our invariant can be significantly improved by introducing a notion of writhe for 2-braids. We feel that we understand how to do this, and plan to return to this in future work.

### 4.3.1. Smoothing functor

**Notation 4.3.1.1.** Let  $\mathbb{S} = (\mathbb{R}, A^1, A^{2,d}, A^{2,t})$  be a datum for smoothing of 2-braids.

**Notation 4.3.1.2.** Let us denote by  $\text{Smoothing}(\text{LowerOverRightOver})$  the functor

$$\mathcal{S} \longrightarrow 2\text{-TL}(\mathbb{S})$$

corresponding to the 2-arrow

$$\left( A_1^{2,d} \otimes id(id(2)) \right) \oplus \left( A_2^{2,d} \otimes \text{LowerRight} \right)$$

of  $2\text{-TL}(\mathbb{S})$ .

**Notation 4.3.1.3.** Let us denote by  $\text{Smoothing}(\text{UpperOverRightUnder})$  the functor

$$\mathcal{S} \longrightarrow 2\text{-TL}(\mathbb{S})$$

corresponding to the 2-arrow

$$\left( A_1^{2,d} \otimes id(id(2)) \right) \oplus \left( A_2^{2,d} \otimes \text{UpperRight} \right)$$

of  $2\text{-TL}(\mathbb{S})$ .

**Notation 4.3.1.4.** Let us denote by  $\text{Smoothing}(\text{LowerUnderRightUnder})$  the functor

$$\mathcal{S} \longrightarrow 2\text{-TL}(\mathbb{S})$$

corresponding to the 2-arrow

$$\left( A_2^{2,d} \otimes id(id(2)) \right) \oplus \left( A_1^{2,d} \otimes \text{LowerRight} \right)$$

of  $2\text{-TL}(\mathbb{S})$ .

**Notation 4.3.1.5.** Let us denote by  $\text{Smoothing}(\text{UpperUnderRightOver})$  the functor

$$\mathcal{S} \longrightarrow 2\text{-TL}(\mathbb{S})$$

corresponding to the 2-arrow

$$\left( A_2^{2,d} \otimes id(id(2)) \right) \oplus \left( A_1^{2,d} \otimes \text{UpperRight} \right)$$

of  $2\text{-TL}(\mathbb{S})$ .



**Notation 4.3.1.6.** Let us denote by  $\text{Smoothing}(\text{LowerOverLeftUnder})$  the functor

$$\mathcal{S} \longrightarrow 2\text{-TL}(\mathbb{S})$$

corresponding to the 2-arrow

$$\left( A_2^{2,d} \otimes id(id(2)) \right) \oplus \left( A_1^{2,d} \otimes \text{LowerLeft} \right)$$

of  $2\text{-TL}(\mathbb{S})$ .

**Notation 4.3.1.7.** Let us denote by  $\text{Smoothing}(\text{UpperOverLeftOver})$  the functor

$$\mathcal{S} \longrightarrow 2\text{-TL}(\mathbb{S})$$

corresponding to the 2-arrow

$$\left( A_2^{2,d} \otimes id(id(2)) \right) \oplus \left( A_1^{2,d} \otimes \text{UpperLeft} \right)$$

of  $2\text{-TL}(\mathbb{S})$ .

**Notation 4.3.1.8.** Let us denote by  $\text{Smoothing}(\text{LowerUnderLeftOver})$  the functor

$$\mathcal{S} \longrightarrow 2\text{-TL}(\mathbb{S})$$

corresponding to the 2-arrow

$$\left( A_1^{2,d} \otimes id(id(2)) \right) \oplus \left( A_2^{2,d} \otimes \text{LowerLeft} \right)$$

of  $2\text{-TL}(\mathbb{S})$ .

**Notation 4.3.1.9.** Let us denote by  $\text{Smoothing}(\text{LowerUnderLeftUnder})$  the functor

$$\mathcal{S} \longrightarrow 2\text{-TL}(\mathbb{S})$$

corresponding to the 2-arrow

$$\left( A_1^{2,d} \otimes id(id(2)) \right) \oplus \left( A_2^{2,d} \otimes \text{UpperLeft} \right)$$

of  $2\text{-TL}(\mathbb{S})$ .

**Notation 4.3.1.10.** Let

$$\bigsqcup_8 \mathcal{S} \xrightarrow{\bigsqcup_8 \text{Smoothing}} 2\text{-TL}(\mathbb{S})$$

denote the canonical functor such that the following hold.

(1) The following diagram in 2-Cat commutes.

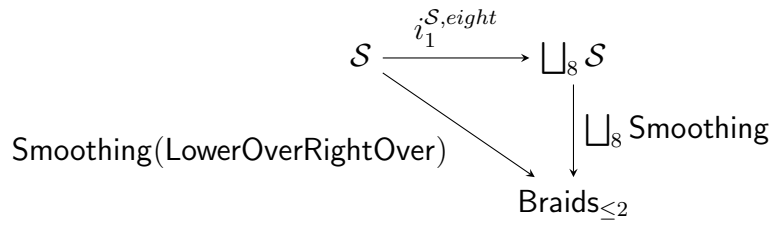

(2) The following diagram in 2-Cat commutes.

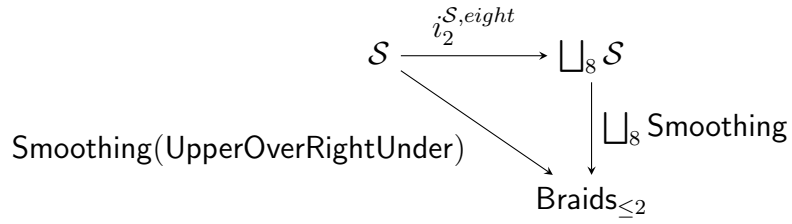

(3) The following diagram in 2-Cat commutes.

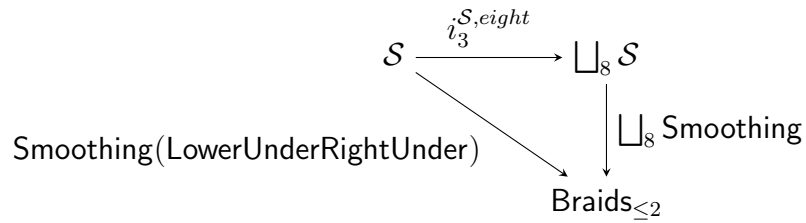

(4) The following diagram in 2-Cat commutes.

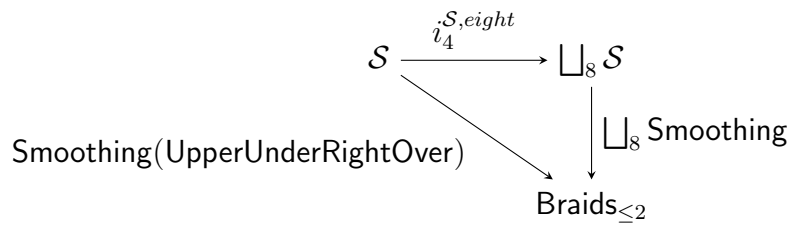

(5) The following diagram in 2-Cat commutes.

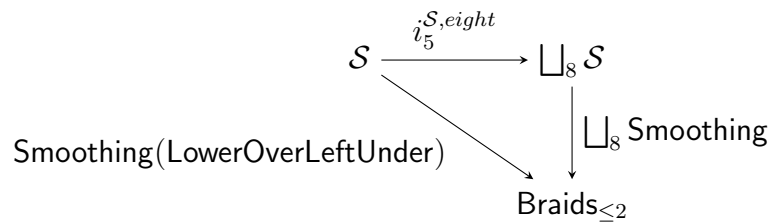

(6) The following diagram in 2-Cat commutes.

$$\begin{array}{ccc}
 \mathcal{S} & \xrightarrow{i_6^{\mathcal{S},eight}} & \bigsqcup_8 \mathcal{S} \\
 \text{Smoothing(UpperOverLeftOver)} \searrow & & \downarrow \bigsqcup_8 \text{Smoothing} \\
 & & \text{Braids}_{\leq 2}
 \end{array}$$

(7) The following diagram in 2-Cat commutes.

$$\begin{array}{ccc}
 \mathcal{S} & \xrightarrow{i_7^{\mathcal{S},eight}} & \bigsqcup_8 \mathcal{S} \\
 \text{Smoothing(LowerUnderLeftOver)} \searrow & & \downarrow \bigsqcup_8 \text{Smoothing} \\
 & & \text{Braids}_{\leq 2}
 \end{array}$$

(8) The following diagram in 2-Cat commutes.

$$\begin{array}{ccc}
 \mathcal{S} & \xrightarrow{i_8^{\mathcal{S},eight}} & \bigsqcup_8 \mathcal{S} \\
 \text{Smoothing(UpperUnderLeftOver)} \searrow & & \downarrow \bigsqcup_8 \text{Smoothing} \\
 & & \text{Braids}_{\leq 2}
 \end{array}$$

**Proposition 4.3.1.11.** *The following diagram in 2-Cat commutes.*

$$\begin{array}{ccc}
 \bigsqcup_8 \partial \mathcal{S} & \xrightarrow{\bigsqcup_8 \iota} & \bigsqcup_8 \mathcal{S} \\
 \bigsqcup_8 \text{generators} \downarrow & & \downarrow \bigsqcup_8 \text{Smoothing} \\
 \text{Braids}_{\leq 2} & \xrightarrow{\text{Smoothing}} & 2\text{-TL}(\mathbb{S})
 \end{array}$$

**Notation 4.3.1.12.** Appealing to Proposition 4.3.1.11, let us denote by

$$2\text{-Braids}_{\leq 2}^{\text{double}} \xrightarrow{\text{Smoothing}} 2\text{-TL}(\mathbb{S})$$

the canonical functor such that the following diagram in 2-Cat commutes.

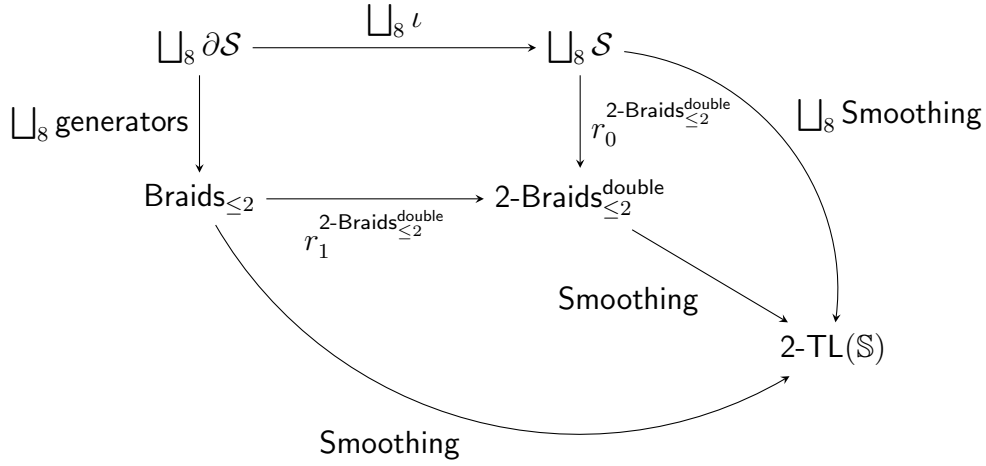

**Proposition 4.3.1.13.** *The following diagram in 2-Cat commutes.*

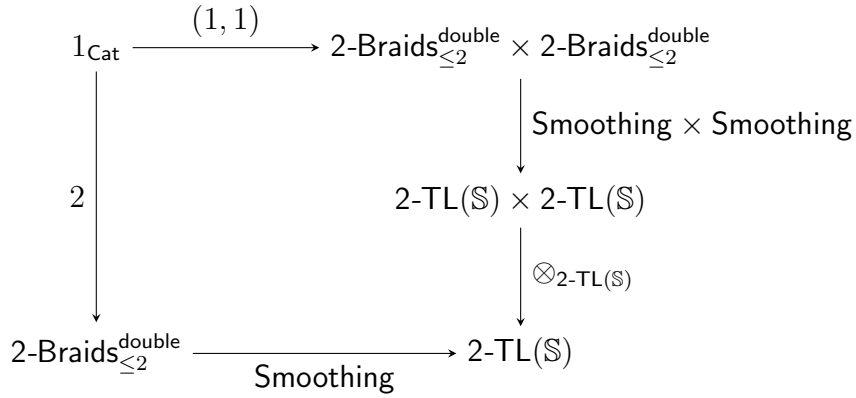

**Corollary 4.3.1.14.** *The functor*

$$2\text{-Braids}_{\leq 2}^{\text{double}} \xrightarrow{\text{Smoothing}} 2\text{-TL}(\mathbb{S})^{\text{mult}}$$

*exhibits  $\mathbb{M}_{2\text{-Braids}_{\leq 2}^{\text{double}}}$  as a monoidal datum for  $2\text{-TL}(\mathbb{S})^{\text{mult}}$ .*

**Notation 4.3.1.15.** Appealing to Corollary 4.3.1.14, let

$$2\text{-Braids}_{\leq 2}^{\text{double}} \xrightarrow{\text{Smoothing}} 2\text{-TL}(\mathbb{S})^{\text{mult}}$$

denote the canonical functor of strict monoidal cubical 2-categories to which the functor

$$2\text{-Braids}_{\leq 2}^{\text{double}} \xrightarrow{\text{Smoothing}} 2\text{-TL}(\mathbb{S})$$

gives rise, by means of the universal property of  $2\text{-Braids}_{\leq 2}^{\text{double}}$ .

**Notation 4.3.1.16.** Let us denote by **Smoothing(TwoUnOnce)** the canonical functor of strict monoidal cubical 2-categories

$$F(\partial\mathcal{S}) \longrightarrow 2\text{-TL}(\mathbb{S})^{\text{mult}}$$

to which the functor

$$\mathcal{S} \longrightarrow 2\text{-TL}(\mathbb{S})$$

corresponding to the 2-arrow

$$\begin{aligned} & \left( A_5^{2,t} \otimes id(id(3)) \right) \oplus \left( A_1^{2,t} \otimes \tau_1^{2,t} \right) \oplus \left( A_6^{2,t} \otimes \tau_2^{2,t} \right) \oplus \left( A_7^{2,t} \otimes \tau_4^{2,t} \right) \\ & \oplus \left( A_2^{2,t} \otimes \tau_5^{2,t} \right) \oplus \left( A_3^{2,t} \otimes \tau_9^{2,t} \right) \oplus \left( A_8^{2,t} \otimes \tau_{10}^{2,t} \right) \oplus \left( A_4^{2,t} \otimes \tau_{12}^{2,t} \right) \end{aligned}$$

**Notation 4.3.1.17.** Let us denote by **Smoothing(OneOnceTwice)** the canonical functor of strict monoidal cubical 2-categories

$$F(\partial\mathcal{S}) \longrightarrow 2\text{-TL}(\mathbb{S})^{\text{mult}}$$

to which the functor

$$\mathcal{S} \longrightarrow 2\text{-TL}(\mathbb{S})$$

corresponding to the 2-arrow

$$\begin{aligned} & \left( A_1^{2,t} \otimes \tau_1^{2,t} \right) \oplus \left( A_2^{2,t} \otimes \tau_6^{2,t} \right) \oplus \left( A_3^{2,t} \otimes \tau_7^{2,t} \right) \oplus \left( A_4^{2,t} \otimes \tau_{11}^{2,t} \right) \\ & \oplus \left( A_5^{2,t} \otimes id(id(3)) \right) \oplus \left( A_6^{2,t} \otimes \tau_2^{2,t} \right) \oplus \left( A_7^{2,t} \otimes \tau_3^{2,t} \right) \oplus \left( A_8^{2,t} \otimes \tau_8^{2,t} \right). \end{aligned}$$

**Notation 4.3.1.18.** Let us denote by **Smoothing(TwoUnTwice)** the canonical functor of strict monoidal cubical 2-categories

$$F(\partial\mathcal{S}) \longrightarrow 2\text{-TL}(\mathbb{S})^{\text{mult}}$$

to which the functor

$$\mathcal{S} \longrightarrow 2\text{-TL}(\mathbb{S})$$

corresponding to the 2-arrow

$$\begin{aligned} & \left( A_1^{2,t} \otimes \tau_9^{2,t} \right) \oplus \left( A_2^{2,t} \otimes \tau_{12}^{2,t} \right) \oplus \left( A_3^{2,t} \otimes \tau_1^{2,t} \right) \oplus \left( A_4^{2,t} \otimes \tau_5^{2,t} \right) \\ & \oplus \left( A_5^{2,t} \otimes \tau_4^{2,t} \right) \oplus \left( A_6^{2,t} \otimes \tau_{10}^{2,t} \right) \oplus \left( A_7^{2,t} \otimes id(id(3)) \right) \oplus \left( A_8^{2,t} \otimes \tau_2^{2,t} \right). \end{aligned}$$

**Notation 4.3.1.19.** Let us denote by `Smoothing(OneTwiceOnce)` the canonical functor of strict monoidal cubical 2-categories

$$F(\partial\mathcal{S}) \longrightarrow 2\text{-TL}(\mathbb{S})^{\text{mult}}$$

to which the functor

$$\mathcal{S} \longrightarrow 2\text{-TL}(\mathbb{S})$$

corresponding to the 2-arrow

$$\begin{aligned} & \left( A_1^{2,t} \otimes \tau_7^{2,t} \right) \oplus \left( A_2^{2,t} \otimes \tau_{11}^{2,t} \right) \oplus \left( A_3^{2,t} \otimes \tau_1^{2,t} \right) \oplus \left( A_4^{2,t} \otimes \tau_6^{2,t} \right) \\ & \oplus \left( A_5^{2,t} \otimes \tau_3^{2,t} \right) \oplus \left( A_6^{2,t} \otimes \tau_8^{2,t} \right) \oplus \left( A_7^{2,t} \otimes id(id(3)) \right) \oplus \left( A_8^{2,t} \otimes \tau_2^{2,t} \right). \end{aligned}$$

**Notation 4.3.1.20.** Let us denote by `Smoothing(TwoOnceUn)` the canonical functor of strict monoidal cubical 2-categories

$$F(\partial\mathcal{S}) \longrightarrow 2\text{-TL}(\mathbb{S})^{\text{mult}}$$

to which the functor

$$\mathcal{S} \longrightarrow 2\text{-TL}(\mathbb{S})$$

corresponding to the 2-arrow

$$\begin{aligned} & \left( A_1^{2,t} \otimes id(id(3)) \right) \oplus \left( A_2^{2,t} \otimes \tau_2^{2,t} \right) \oplus \left( A_3^{2,t} \otimes \tau_4^{2,t} \right) \oplus \left( A_4^{2,t} \otimes \tau_{10}^{2,t} \right) \\ & \oplus \left( A_5^{2,t} \otimes \tau_1^{2,t} \right) \oplus \left( A_6^{2,t} \otimes \tau_5^{2,t} \right) \oplus \left( A_7^{2,t} \otimes \tau_9^{2,t} \right) \oplus \left( A_8^{2,t} \otimes \tau_{12}^{2,t} \right). \end{aligned}$$

**Notation 4.3.1.21.** Let us denote by `Smoothing(OneUnTwice)` the canonical functor of strict monoidal cubical 2-categories

$$F(\partial\mathcal{S}) \longrightarrow 2\text{-TL}(\mathbb{S})^{\text{mult}}$$

to which the functor

$$\mathcal{S} \longrightarrow 2\text{-TL}(\mathbb{S})$$

corresponding to the 2-arrow

$$\begin{aligned} & \left( A_1^{2,t} \otimes id(id(3)) \right) \oplus \left( A_2^{2,t} \otimes \tau_2^{2,t} \right) \oplus \left( A_3^{2,t} \otimes \tau_3^{2,t} \right) \oplus \left( A_4^{2,t} \otimes \tau_8^{2,t} \right) \\ & \oplus \left( A_5^{2,t} \otimes \tau_1^{2,t} \right) \oplus \left( A_6^{2,t} \otimes \tau_6^{2,t} \right) \oplus \left( A_7^{2,t} \otimes \tau_7^{2,t} \right) \oplus \left( A_8^{2,t} \otimes \tau_{11}^{2,t} \right). \end{aligned}$$

**Notation 4.3.1.22.** Let us denote by  $\text{Smoothing}(\text{TwoTwiceUn})$  the canonical functor of strict monoidal cubical 2-categories

$$F(\partial\mathcal{S}) \longrightarrow 2\text{-TL}(\mathbb{S})^{\text{mult}}$$

to which the functor

$$\mathcal{S} \longrightarrow 2\text{-TL}(\mathbb{S})$$

corresponding to the 2-arrow

$$\begin{aligned} & \left( A_1^{2,t} \otimes \tau_2^{2,t} \right) \oplus \left( A_2^{2,t} \otimes id(id(3)) \right) \oplus \left( A_3^{2,t} \otimes \tau_{10}^{2,t} \right) \oplus \left( A_4^{2,t} \otimes \tau_4^{2,t} \right) \\ & \oplus \left( A_5^{2,t} \otimes \tau_5^{2,t} \right) \oplus \left( A_6^{2,t} \otimes \tau_1^{2,t} \right) \oplus \left( A_7^{2,t} \otimes \tau_{12}^{2,t} \right) \oplus \left( A_8^{2,t} \otimes \tau_9^{2,t} \right). \end{aligned}$$

**Notation 4.3.1.23.** Let us denote by  $\text{Smoothing}(\text{OneUnOnce})$  the canonical functor of strict monoidal cubical 2-categories

$$F(\partial\mathcal{S}) \longrightarrow 2\text{-TL}(\mathbb{S})^{\text{mult}}$$

to which the functor

$$\mathcal{S} \longrightarrow 2\text{-TL}(\mathbb{S})$$

corresponding to the 2-arrow

$$\begin{aligned} & \left( A_1^{2,t} \otimes \tau_2^{2,t} \right) \oplus \left( A_2^{2,t} \otimes id(id(3)) \right) \oplus \left( A_3^{2,t} \otimes \tau_8^{2,t} \right) \oplus \left( A_4^{2,t} \otimes \tau_3^{2,t} \right) \\ & \oplus \left( A_5^{2,t} \otimes \tau_6^{2,t} \right) \oplus \left( A_6^{2,t} \otimes \tau_1^{2,t} \right) \oplus \left( A_7^{2,t} \otimes \tau_{11}^{2,t} \right) \oplus \left( A_8^{2,t} \otimes \tau_7^{2,t} \right). \end{aligned}$$

**Notation 4.3.1.24.** Let us denote by  $\text{Smoothing}(\text{TwoOnceTwice})$  the canonical functor of strict monoidal cubical 2-categories

$$F(\partial\mathcal{S}) \longrightarrow 2\text{-TL}(\mathbb{S})^{\text{mult}}$$

to which the functor

$$\mathcal{S} \longrightarrow 2\text{-TL}(\mathbb{S})$$

corresponding to the 2-arrow

$$\begin{aligned} & \left( A_1^{2,t} \otimes \tau_{12}^{2,t} \right) \oplus \left( A_2^{2,t} \otimes \tau_9^{2,t} \right) \oplus \left( A_3^{2,t} \otimes \tau_5^{2,t} \right) \oplus \left( A_4^{2,t} \otimes \tau_1^{2,t} \right) \\ & \oplus \left( A_5^{2,t} \otimes \tau_{10}^{2,t} \right) \oplus \left( A_6^{2,t} \otimes \tau_4^{2,t} \right) \oplus \left( A_7^{2,t} \otimes \tau_2^{2,t} \right) \oplus \left( A_8^{2,t} \otimes id(id(3)) \right). \end{aligned}$$

**Notation 4.3.1.25.** Let us denote by  $\text{Smoothing}(\text{OneTwiceUn})$  the canonical functor of strict monoidal cubical 2-categories

$$F(\partial\mathcal{S}) \longrightarrow 2\text{-TL}(\mathbb{S})^{\text{mult}}$$

to which the functor

$$\mathcal{S} \longrightarrow 2\text{-TL}(\mathbb{S})$$

corresponding to the 2-arrow

$$\begin{aligned} & \left( A_1^{2,t} \otimes \tau_{11}^{2,t} \right) \oplus \left( A_2^{2,t} \otimes \tau_7^{2,t} \right) \oplus \left( A_3^{2,t} \otimes \tau_6^{2,t} \right) \oplus \left( A_4^{2,t} \otimes \tau_1^{2,t} \right) \\ & \oplus \left( A_5^{2,t} \otimes \tau_8^{2,t} \right) \oplus \left( A_6^{2,t} \otimes \tau_3^{2,t} \right) \oplus \left( A_7^{2,t} \otimes \tau_2^{2,t} \right) \oplus \left( A_8^{2,t} \otimes \text{id}(\text{id}(3)) \right). \end{aligned}$$

**Notation 4.3.1.26.** Let us denote by  $\text{Smoothing}(\text{TwoTwiceOnce})$  the canonical functor of strict monoidal cubical 2-categories

$$F(\partial\mathcal{S}) \longrightarrow 2\text{-TL}(\mathbb{S})^{\text{mult}}$$

to which the functor

$$\mathcal{S} \longrightarrow 2\text{-TL}(\mathbb{S})$$

corresponding to the 2-arrow

$$\begin{aligned} & \left( A_1^{2,t} \otimes \tau_{10}^{2,t} \right) \oplus \left( A_2^{2,t} \otimes \tau_4^{2,t} \right) \oplus \left( A_3^{2,t} \otimes \tau_2^{2,t} \right) \oplus \left( A_4^{2,t} \otimes \text{id}(\text{id}(3)) \right) \\ & \oplus \left( A_5^{2,t} \otimes \tau_{12}^{2,t} \right) \oplus \left( A_6^{2,t} \otimes \tau_9^{2,t} \right) \oplus \left( A_7^{2,t} \otimes \tau_5^{2,t} \right) \oplus \left( A_8^{2,t} \otimes \tau_1^{2,t} \right). \end{aligned}$$

**Notation 4.3.1.27.** Let us denote by  $\text{Smoothing}(\text{OneOnceUn})$  the canonical functor of strict monoidal cubical 2-categories

$$F(\partial\mathcal{S}) \longrightarrow 2\text{-TL}(\mathbb{S})^{\text{mult}}$$

to which the functor

$$\mathcal{S} \longrightarrow 2\text{-TL}(\mathbb{S})$$

corresponding to the 2-arrow

$$\begin{aligned} & \left( A_1^{2,t} \otimes \tau_8^{2,t} \right) \oplus \left( A_2^{2,t} \otimes \tau_3^{2,t} \right) \oplus \left( A_3^{2,t} \otimes \tau_2^{2,t} \right) \oplus \left( A_4^{2,t} \otimes \text{id}(\text{id}(3)) \right) \\ & \oplus \left( A_5^{2,t} \otimes \tau_{11}^{2,t} \right) \oplus \left( A_6^{2,t} \otimes \tau_7^{2,t} \right) \oplus \left( A_7^{2,t} \otimes \tau_6^{2,t} \right) \oplus \left( A_8^{2,t} \otimes \tau_1^{2,t} \right). \end{aligned}$$



**Notation 4.3.1.28.** Let

$$\bigsqcup_{12} F(\mathcal{S}) \xrightarrow{\sqcup \text{Smoothing}} 2\text{-TL}(\mathcal{S})^{\text{mult}}$$

denote the canonical functor such that the following hold.

(1) The following diagram in 2-Cat commutes.

$$\begin{array}{ccc} F(\mathcal{S}) & \xrightarrow{i_1^{F(\mathcal{S}), \text{twelve}}} & \bigsqcup_{12} F(\mathcal{S}) \\ & \searrow \text{Smoothing}(\text{TwoUnOnce}) & \downarrow \bigsqcup_{12} \text{Smoothing} \\ & & 2\text{-TL}(\mathcal{S})^{\text{mult}} \end{array}$$

(2) The following diagram in 2-Cat commutes.

$$\begin{array}{ccc} F(\mathcal{S}) & \xrightarrow{i_2^{F(\mathcal{S}), \text{twelve}}} & \bigsqcup_{12} F(\mathcal{S}) \\ & \searrow \text{Smoothing}(\text{OneOnceTwice}) & \downarrow \bigsqcup_{12} \text{Smoothing} \\ & & 2\text{-TL}(\mathcal{S})^{\text{mult}} \end{array}$$

(3) The following diagram in 2-Cat commutes.

$$\begin{array}{ccc} F(\mathcal{S}) & \xrightarrow{i_3^{F(\mathcal{S}), \text{twelve}}} & \bigsqcup_{12} F(\mathcal{S}) \\ & \searrow \text{Smoothing}(\text{TwoUnTwice}) & \downarrow \bigsqcup_{12} \text{Smoothing} \\ & & 2\text{-TL}(\mathcal{S})^{\text{mult}} \end{array}$$

(4) The following diagram in 2-Cat commutes.

$$\begin{array}{ccc} F(\mathcal{S}) & \xrightarrow{i_4^{F(\mathcal{S}), \text{twelve}}} & \bigsqcup_{12} F(\mathcal{S}) \\ & \searrow \text{Smoothing}(\text{OneTwiceOnce}) & \downarrow \bigsqcup_{12} \text{Smoothing} \\ & & 2\text{-TL}(\mathcal{S})^{\text{mult}} \end{array}$$

(5) The following diagram in 2-Cat commutes.

$$\begin{array}{ccc}
 F(\mathcal{S}) & \xrightarrow{i_5^{F(\mathcal{S}),twelve}} & \bigsqcup_{12} F(\mathcal{S}) \\
 \searrow \text{Smoothing(TwoOnceUn)} & & \downarrow \bigsqcup_{12} \text{Smoothing} \\
 & & 2\text{-TL}(\mathcal{S})^{\text{mult}}
 \end{array}$$

(6) The following diagram in 2-Cat commutes.

$$\begin{array}{ccc}
 F(\mathcal{S}) & \xrightarrow{i_6^{F(\mathcal{S}),twelve}} & \bigsqcup_{12} F(\mathcal{S}) \\
 \searrow \text{Smoothing(OneUnTwice)} & & \downarrow \bigsqcup_{12} \text{Smoothing} \\
 & & 2\text{-TL}(\mathcal{S})^{\text{mult}}
 \end{array}$$

(7) The following diagram in 2-Cat commutes.

$$\begin{array}{ccc}
 F(\mathcal{S}) & \xrightarrow{i_7^{F(\mathcal{S}),twelve}} & \bigsqcup_{12} F(\mathcal{S}) \\
 \searrow \text{Smoothing(TwoTwiceUn)} & & \downarrow \bigsqcup_{12} \text{Smoothing} \\
 & & 2\text{-TL}(\mathcal{S})^{\text{mult}}
 \end{array}$$

(8) The following diagram in 2-Cat commutes.

$$\begin{array}{ccc}
 F(\mathcal{S}) & \xrightarrow{i_8^{F(\mathcal{S}),twelve}} & \bigsqcup_{12} F(\mathcal{S}) \\
 \searrow \text{Smoothing(OneUnOnce)} & & \downarrow \bigsqcup_{12} \text{Smoothing} \\
 & & 2\text{-TL}(\mathcal{S})^{\text{mult}}
 \end{array}$$

(9) The following diagram in 2-Cat commutes.

$$\begin{array}{ccc}
F(\mathcal{S}) & \xrightarrow{i_9^{F(\mathcal{S}),twelve}} & \bigsqcup_{12} F(\mathcal{S}) \\
\searrow \text{Smoothing(TwoOnceTwice)} & & \downarrow \bigsqcup_{12} \text{Smoothing} \\
& & 2\text{-TL}(\mathbb{S})^{\text{mult}}
\end{array}$$

(10) The following diagram in 2-Cat commutes.

$$\begin{array}{ccc}
F(\mathcal{S}) & \xrightarrow{i_{10}^{F(\mathcal{S}),twelve}} & \bigsqcup_{12} F(\mathcal{S}) \\
\searrow \text{Smoothing(OneTwiceUn)} & & \downarrow \bigsqcup_{12} \text{Smoothing} \\
& & 2\text{-TL}(\mathbb{S})^{\text{mult}}
\end{array}$$

(11) The following diagram in 2-Cat commutes.

$$\begin{array}{ccc}
F(\mathcal{S}) & \xrightarrow{i_{11}^{F(\mathcal{S}),twelve}} & \bigsqcup_{12} F(\mathcal{S}) \\
\searrow \text{Smoothing(TwoTwiceOnce)} & & \downarrow \bigsqcup_{12} \text{Smoothing} \\
& & 2\text{-TL}(\mathbb{S})^{\text{mult}}
\end{array}$$

(12) The following diagram in 2-Cat commutes.

$$\begin{array}{ccc}
F(\mathcal{S}) & \xrightarrow{i_{12}^{F(\mathcal{S}),twelve}} & \bigsqcup_{12} F(\mathcal{S}) \\
\searrow \text{Smoothing(OneOnceUn)} & & \downarrow \bigsqcup_{12} \text{Smoothing} \\
& & 2\text{-TL}(\mathbb{S})^{\text{mult}}
\end{array}$$

**Proposition 4.3.1.29.** *The following diagram in Mon(Cat) commutes.*

$$\begin{array}{ccc}
\bigsqcup_{12} F(\partial\mathcal{S}) & \xrightarrow{\bigsqcup_{12} \iota} & \bigsqcup_{12} F(\mathcal{S}) \\
\downarrow \bigsqcup \text{generators} & & \downarrow \bigsqcup_{12} \text{Smoothing} \\
2\text{-Braids}^{\text{double}} & \xrightarrow{\text{Smoothing}} & 2\text{-TL}(\mathbb{S})^{\text{mult}}
\end{array}$$

**Notation 4.3.1.30.** Appealing to Proposition 4.3.1.29, let

$$2\text{-Braids} \xrightarrow{\text{Smoothing}} 2\text{-TL}(\mathbb{S})^{\text{mult}}$$

denote the canonical functor of strict monoidal cubical 2-categories such that the following diagram in  $\text{Mon}(2\text{-Cat})$  commutes.

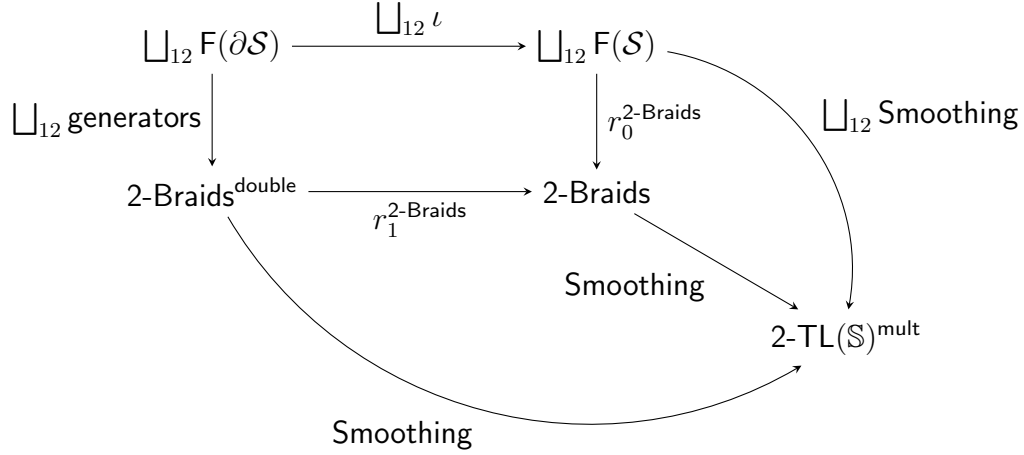

### 4.3.2. The Kauffman 2-bracket

**Notation 4.3.2.1.** Let  $F_{\text{Mon}}(\mathcal{S})$  denote the free strict monoidal cubical 2-category on  $\mathcal{S}$ .

**Remark 4.3.2.2.** Let  $F_{3\text{-ring}}(\mathcal{S})$  denote the free 3-ring on  $\mathcal{I}$ . Appealing to Fact 2.2.3.4, we have that  $F_{3\text{-ring}}(\mathcal{S})$  can be viewed as the free 3-ring on  $F_{\text{Mon}}(\mathcal{S})$ .

**Notation 4.3.2.3.** For  $1 \leq j \leq 2$ , let

$$F_{3\text{-ring}}(\mathcal{S}) \xrightarrow{\text{Tr}^{\mathbb{S}} \circ \text{Smoothing} \circ \text{Bubble}_{j^{\text{th}}}(\text{one half})} \mathbb{T}$$

be the functor of 3-rings to which, by means of the universal property of  $F_{3\text{-ring}}(\mathcal{S})$  as the free 3-ring on  $F_{\text{Mon}}(\mathcal{S})$ , the strict monoidal functor

$$\mathcal{F}_{\mathcal{M} \setminus \setminus}(\mathcal{S}) \xrightarrow{\text{Tr}^{\mathbb{S}} \circ \text{Smoothing} \circ \text{Bubble}_{j^{\text{th}}}(\text{one half})} \mathbb{T}^{\text{mult}}$$

gives rise.

**Notation 4.3.2.4.** For  $1 \leq j \leq 4$ , let

$$F_{3\text{-ring}}(\mathcal{S}) \xrightarrow{\text{Tr}^{\mathbb{S}} \circ \text{Smoothing} \circ \text{Saddle}_{j^{\text{th}}}(\text{one half})} \mathbb{T}$$

be the functor of 3-rings to which, by means of the universal property of  $F_{3\text{-ring}}(\mathcal{S})$  as the free 3-ring on  $F_{\text{Mon}}(\mathcal{S})$ , the strict monoidal functor

$$\mathcal{F}_{\mathcal{M}_\lambda}(\mathcal{S}) \xrightarrow{\text{Tr}^{\mathbb{S}} \circ \text{Smoothing} \circ \text{Saddle}_{j^{\text{th}}}(\text{one half})} \mathbb{T}^{\text{mult}}$$

gives rise.

**Notation 4.3.2.5.** For  $1 \leq j \leq 12$ , let

$$F_{3\text{-ring}}(\mathcal{S}) \xrightarrow{\text{Tr}^{\mathbb{S}} \circ \text{Smoothing} \circ \text{Triple}_{j^{\text{th}}}(\text{one half})} \mathbb{T}$$

be the functor of 3-rings to which, by means of the universal property of  $F_{3\text{-ring}}(\mathcal{S})$  as the free 3-ring on  $F_{\text{Mon}}(\mathcal{S})$ , the strict monoidal functor

$$\mathcal{F}_{\mathcal{M}_\lambda}(\mathcal{S}) \xrightarrow{\text{Tr}^{\mathbb{S}} \circ \text{Smoothing} \circ \text{Triple}_{j^{\text{th}}}(\text{one half})} \mathbb{T}^{\text{mult}}$$

gives rise.

**Notation 4.3.2.6.** For  $1 \leq j \leq 48$ , let

$$F_{3\text{-ring}}(\mathcal{S}) \xrightarrow{\text{Tr}^{\mathbb{S}} \circ \text{Smoothing} \circ \text{Tetrahedral}_{j^{\text{th}}}(\text{one half})} \mathbb{T}$$

be the functor of 3-rings to which, by means of the universal property of  $F_{3\text{-ring}}(\mathcal{S})$  as the free 3-ring on  $F_{\text{Mon}}(\mathcal{S})$ , the strict monoidal functor

$$\mathcal{F}_{\mathcal{M}_\lambda}(\mathcal{S}) \xrightarrow{\text{Tr}^{\mathbb{S}} \circ \text{Smoothing} \circ \text{Tetrahedral}_{j^{\text{th}}}(\text{one half})} \mathbb{T}^{\text{mult}}$$

gives rise.

**Notation 4.3.2.7.** For  $1 \leq j \leq 2$ , let

$$F_{3\text{-ring}}(\mathcal{S}) \xrightarrow{\text{Tr}^{\mathbb{S}} \circ \text{Smoothing} \circ \text{Bubble}_{j^{\text{th}}}(\text{other half})} \mathbb{T}$$

be the functor of 3-rings to which, by means of the universal property of  $F_{3\text{-ring}}(\mathcal{S})$  as the free 3-ring on  $F_{\text{Mon}}(\mathcal{S})$ , the strict monoidal functor

$$\mathcal{F}_{\mathcal{M}_\lambda}(\mathcal{S}) \xrightarrow{\text{Tr}^{\mathbb{S}} \circ \text{Smoothing} \circ \text{Bubble}_{j^{\text{th}}}(\text{other half})} \mathbb{T}^{\text{mult}}$$

gives rise.

**Notation 4.3.2.8.** For  $1 \leq j \leq 4$ , let

$$F_{3\text{-ring}}(\mathcal{S}) \xrightarrow{\text{Tr}^{\mathcal{S}} \circ \text{Smoothing} \circ \text{Saddle}_{j^{\text{th}}}(\text{other half})} \mathbb{T}$$

be the functor of 3-rings to which, by means of the universal property of  $F_{3\text{-ring}}(\mathcal{S})$  as the free 3-ring on  $F_{\text{Mon}}(\mathcal{S})$ , the strict monoidal functor

$$\mathcal{F}_{\mathcal{M}\lambda}(\mathcal{S}) \xrightarrow{\text{Tr}^{\mathcal{S}} \circ \text{Smoothing} \circ \text{Saddle}_{j^{\text{th}}}(\text{other half})} \mathbb{T}^{\text{mult}}$$

gives rise.

**Notation 4.3.2.9.** For  $1 \leq j \leq 12$ , let

$$F_{3\text{-ring}}(\mathcal{S}) \xrightarrow{\text{Tr}^{\mathcal{S}} \circ \text{Smoothing} \circ \text{Triple}_{j^{\text{th}}}(\text{other half})} \mathbb{T}$$

be the functor of 3-rings to which, by means of the universal property of  $F_{3\text{-ring}}(\mathcal{S})$  as the free 3-ring on  $F_{\text{Mon}}(\mathcal{S})$ , the strict monoidal functor

$$\mathcal{F}_{\mathcal{M}\lambda}(\mathcal{S}) \xrightarrow{\text{Tr}^{\mathcal{S}} \circ \text{Smoothing} \circ \text{Triple}_{j^{\text{th}}}(\text{other half})} \mathbb{T}^{\text{mult}}$$

gives rise.

**Notation 4.3.2.10.** For  $1 \leq j \leq 48$ , let

$$F_{3\text{-ring}}(\mathcal{S}) \xrightarrow{\text{Tr}^{\mathcal{S}} \circ \text{Smoothing} \circ \text{Tetrahedral}_{j^{\text{th}}}(\text{other half})} \mathbb{T}$$

be the functor of 3-rings to which, by means of the universal property of  $F_{3\text{-ring}}(\mathcal{S})$  as the free 3-ring on  $F_{\text{Mon}}(\mathcal{S})$ , the strict monoidal functor

$$\mathcal{F}_{\mathcal{M}\lambda}(\mathcal{S}) \xrightarrow{\text{Tr}^{\mathcal{S}} \circ \text{Smoothing} \circ \text{Tetrahedral}_{j^{\text{th}}}(\text{other half})} \mathbb{T}^{\text{mult}}$$

gives rise.

**Notation 4.3.2.11.** Let

$$\begin{array}{ccc} F_{3\text{-ring}}(\mathcal{S}) & \cdots & F_{M3\text{-ring}}(\mathcal{S}) \\ & \searrow & \swarrow \\ & \underset{\iota_1}{\cdot F_{3\text{-ring}}(\mathcal{S}),66} & \underset{\iota_{66}}{\cdot F_{3\text{-ring}}(\mathcal{S}),66} \\ & \searrow & \swarrow \\ & \bigsqcup_{66} F_{\text{Mon}}(\mathcal{S}) & \end{array}$$

be a diagram in  $2\text{-Cat}$  which defines a coproduct of 66 copies of  $F_{3\text{-ring}}(\mathcal{S})$ .

**Notation 4.3.2.12.** Let

$$\bigsqcup_{66} \text{Tr}^{\mathcal{S}} \circ \text{Smoothing} \circ \text{R-moves}(\text{one half}) \longrightarrow \mathbb{T}$$

denote the canonical functor such that the following hold.

- (1) The following diagram in 2-Cat commutes for  $1 \leq j \leq 2$ .

$$\begin{array}{ccc} \text{F}_{3\text{-ring}}(\mathcal{S}) & \xrightarrow{i_j^{\text{F}_{3\text{-ring}}(\mathcal{S}),66}} & \bigsqcup_{66} \text{F}_{3\text{-ring}}(\mathcal{S}) \\ & \searrow & \downarrow \bigsqcup_{66} \text{Tr}^{\mathcal{S}} \circ \text{Smoothing} \circ \text{R-moves}(\text{one half}) \\ \text{Bubble}_{j^{\text{th}}}(\text{one half}) & & \mathbb{T} \end{array}$$

- (2) The following diagram in 2-Cat commutes for  $1 \leq j \leq 4$ .

$$\begin{array}{ccc} \text{F}_{3\text{-ring}}(\mathcal{S}) & \xrightarrow{i_j^{\text{F}_{3\text{-ring}}(\mathcal{S}),66}} & \bigsqcup_{66} \text{F}_{3\text{-ring}}(\mathcal{S}) \\ & \searrow & \downarrow \bigsqcup_{66} \text{Tr}^{\mathcal{S}} \circ \text{Smoothing} \circ \text{R-moves}(\text{one half}) \\ \text{Saddle}_{j^{\text{th}}}(\text{one half}) & & \mathbb{T} \end{array}$$

- (3) The following diagram in 2-Cat commutes for  $1 \leq j \leq 12$ .

$$\begin{array}{ccc} \text{F}_{3\text{-ring}}(\mathcal{S}) & \xrightarrow{i_j^{\text{F}_{3\text{-ring}}(\mathcal{S}),66}} & \bigsqcup_{66} \text{F}_{3\text{-ring}}(\mathcal{S}) \\ & \searrow & \downarrow \bigsqcup_{66} \text{Tr}^{\mathcal{S}} \circ \text{Smoothing} \circ \text{R-moves}(\text{one half}) \\ \text{Triple}_{j^{\text{th}}}(\text{one half}) & & \mathbb{T} \end{array}$$

- (4) The following diagram in 2-Cat commutes for  $1 \leq j \leq 48$ .

$$\begin{array}{ccc} \text{F}_{3\text{-ring}}(\mathcal{S}) & \xrightarrow{i_j^{\text{F}_{3\text{-ring}}(\mathcal{S}),66}} & \bigsqcup_{66} \text{F}_{3\text{-ring}}(\mathcal{S}) \\ & \searrow & \downarrow \bigsqcup_{66} \text{Tr}^{\mathcal{S}} \circ \text{Smoothing} \circ \text{R-moves}(\text{one half}) \\ \text{Tetrahedral}_{j^{\text{th}}}(\text{one half}) & & \mathbb{T} \end{array}$$

**Notation 4.3.2.13.** Let

$$\bigsqcup_{66} \text{Tr}^{\mathcal{S}} \circ \text{Smoothing} \circ \text{R-moves}(\text{other half})$$

$$\bigsqcup_{66} \text{F}_{3\text{-ring}}(\mathcal{S}) \longrightarrow \mathbb{T}$$

denote the canonical functor such that the following hold.

- (1) The following diagram in 2-Cat commutes for  $1 \leq j \leq 2$ .

$$\begin{array}{ccc} \text{F}_{3\text{-ring}}(\mathcal{S}) & \xrightarrow{\iota_j^{\text{F}_{3\text{-ring}}(\mathcal{S}),66}} & \bigsqcup_{66} \text{F}_{3\text{-ring}}(\mathcal{S}) \\ & \searrow & \downarrow \bigsqcup_{66} \text{Tr}^{\mathcal{S}} \circ \text{Smoothing} \circ \text{R-moves}(\text{other half}) \\ \text{Bubble}_{j\text{th}}(\text{other half}) & & \mathbb{T} \end{array}$$

- (2) The following diagram in 2-Cat commutes for  $1 \leq j \leq 4$ .

$$\begin{array}{ccc} \text{F}_{3\text{-ring}}(\mathcal{S}) & \xrightarrow{\iota_j^{\text{F}_{3\text{-ring}}(\mathcal{S}),66}} & \bigsqcup_{66} \text{F}_{3\text{-ring}}(\mathcal{S}) \\ & \searrow & \downarrow \bigsqcup_{66} \text{Tr}^{\mathcal{S}} \circ \text{Smoothing} \circ \text{R-moves}(\text{other half}) \\ \text{Saddle}_{j\text{th}}(\text{other half}) & & \mathbb{T} \end{array}$$

- (3) The following diagram in 2-Cat commutes for  $1 \leq j \leq 12$ .

$$\begin{array}{ccc} \text{F}_{3\text{-ring}}(\mathcal{S}) & \xrightarrow{\iota_j^{\text{F}_{3\text{-ring}}(\mathcal{S}),66}} & \bigsqcup_{66} \text{F}_{3\text{-ring}}(\mathcal{S}) \\ & \searrow & \downarrow \bigsqcup_{66} \text{Tr}^{\mathcal{S}} \circ \text{Smoothing} \circ \text{R-moves}(\text{other half}) \\ \text{Triple}_{j\text{th}}(\text{other half}) & & \mathbb{T} \end{array}$$

- (4) The following diagram in 2-Cat commutes for  $1 \leq j \leq 48$ .

$$\begin{array}{ccc} \text{F}_{3\text{-ring}}(\mathcal{S}) & \xrightarrow{\iota_j^{\text{F}_{3\text{-ring}}(\mathcal{S}),66}} & \bigsqcup_{66} \text{F}_{3\text{-ring}}(\mathcal{S}) \\ & \searrow & \downarrow \bigsqcup_{66} \text{Tr}^{\mathcal{S}} \circ \text{Smoothing} \circ \text{R-moves}(\text{other half}) \\ \text{Tetrahedral}_{j\text{th}}(\text{other half}) & & \mathbb{T} \end{array}$$



**Notation 4.3.2.14.** Appealing to Fact 2.1.3.16, let

$$\bigsqcup_{66} F_{3\text{-ring}}(\mathcal{S}) \begin{array}{c} \xrightarrow{\text{Tr}^{\mathcal{S}} \circ \text{Smoothing} \circ \text{R-moves}(\text{one half})} \\ \xrightarrow{\text{Tr}^{\mathcal{S}} \circ \text{Smoothing} \circ \text{R-moves}(\text{other half})} \end{array} \mathbb{T} \xrightarrow{q_{inv}} \mathbb{T}_{inv}$$

be a coequaliser diagram in  $\text{Ring}(2\text{-Cat})$ .

**Notation 4.3.2.15.** Let us denote by

$$2\text{-Braids} \xrightarrow{K} \mathbb{T}_{inv}^{\text{mult}}$$

the strict monoidal functor  $q_{inv} \circ \text{Tr}^{\mathcal{S}} \circ \text{Smoothing}$ .

**Terminology 4.3.2.16.** We refer to

$$2\text{-Braids} \xrightarrow{K} \mathbb{T}_{inv}^{\text{mult}}$$

as the *Kauffman 2-bracket*.

**Proposition 4.3.2.17.** *The following diagram in  $\text{Mon}(2\text{-Cat})$  commutes.*

$$\begin{array}{ccc} \bigsqcup_{66} F_{\text{Mon}}(\mathcal{S}) & \xrightarrow{\bigsqcup_{66} (\text{one half moves})} & 2\text{-Braids}^{\text{double}} \\ \downarrow \bigsqcup_{66} (\text{other half moves}) & & \downarrow K \\ 2\text{-Braids} & \xrightarrow{K} & \mathbb{T}_{inv}^{\text{mult}} \end{array}$$

**Notation 4.3.2.18.** Appealing to Proposition 4.3.2.17 and the universal property of 2-Braids/R-moves, let us denote by

$$2\text{-Braids/R-moves} \xrightarrow{K/\text{R-moves}} \mathbb{T}_{inv}^{\text{mult}}$$

the canonical strict monoidal functor such that the following diagram in  $\text{Mon}(2\text{-Cat})$  commutes.

$$\begin{array}{ccc} 2\text{-Braids} & \xrightarrow{q_{\text{R-moves}}} & 2\text{-Braids/R-moves} \\ & \searrow K & \downarrow K/\text{R-moves} \\ & & \mathbb{T}_{inv}^{\text{mult}} \end{array}$$

**Terminology 4.3.2.19.** We refer to the functor

$$\text{2-Braids/R-moves} \xrightarrow{\text{K/R-moves}} \mathbb{T}_{\text{inv}}^{\text{mult}}$$

as the *Kauffman 2-bracket invariant* of 2-braids.

**Remark 4.3.2.20.** In our construction of K/R-moves, we defined  $\mathbb{T}_{\text{inv}}$  by forcing the Markov traces of the smoothings of both sides of *every* Roseman move to be equal. This is conceptually correct, but, as in the construction we gave of the Kauffman bracket invariant

$$\text{Braids/R-moves} \xrightarrow{\text{K/R-moves}} \mathbb{T}_{\text{inv}},$$

we might hope that, by making use of Proposition 2.1.3.21, it would suffice to force the Markov traces of the smoothings of both sides of only some of Roseman move to be equal.

Though we omit a formal proof, we believe that, by virtue of Proposition 2.1.3.21, it suffices to force the Markov traces of the smoothings of the following Roseman moves to become equal: one of the bubble moves, one of the saddle moves, and three of the triple moves (such as  $\text{Triple}_{\text{one}}$ ,  $\text{Triple}_{\text{two}}$ , and  $\text{Triple}_{\text{three}}$ ). We do not believe it necessary to force the Markov traces of the smoothings of both sides of any of tetrahedral moves to become equal. This is analogous to the fact that it is not necessary to force the Markov traces of the smoothings of both sides of any of the R3 moves to become equal in the construction of

$$\text{Braids/R-moves} \xrightarrow{\text{K/R-moves}} \mathbb{T}_{\text{inv}}.$$

**Remark 4.3.2.21.** To arrive at an explicit description of  $\mathbb{T}_{\text{inv}}$ , it suffices, given Remark ??, to calculate the Markov traces of the smoothings of the following Roseman moves to become equal: one of the bubble moves, one of the saddle moves, and three of the triple moves (such as  $\text{Triple}_{\text{one}}$ ,  $\text{Triple}_{\text{two}}$ , and  $\text{Triple}_{\text{three}}$ ). Whilst we shall omit the details, we believe that these calculations yield the following.

- (1) We have that  $\text{Smoothing} \circ \text{Bubble}_{\text{one}}(\text{one half})$  is equal to the following 2-arrow of  $\text{TL}(\mathbb{S})$ .

$$\begin{aligned} & \left( \left( (A_1^{2,d} \circ_{\text{ver}} A_1^{2,d}) \circ_{\text{hor}} (A_1^{2,d} \circ_{\text{ver}} A_1^{2,d}) \right) \otimes id(id(2)) \right) \\ \oplus & \left( \left( (A_2^{2,d} \circ_{\text{ver}} A_2^{2,d}) \circ_{\text{hor}} (A_2^{2,d} \circ_{\text{ver}} A_2^{2,d}) \right) \otimes \left( (\tau_{\text{LR}} \circ_{\text{ver}} \tau_{\text{UR}}) \circ_{\text{hor}} (\tau_{\text{LL}} \circ_{\text{ver}} \tau_{\text{UL}}) \right) \right) \end{aligned}$$

Hence  $\text{Tr}^{\mathbb{S}} \circ \text{Smoothing} \circ \text{Bubble}_{\text{one}}(\text{one half})$  is equal to the following 2-arrow of  $\mathbb{T}$ .

$$(A_1^{2,d})^4 \oplus (A_2^{2,d})^4 \gamma^4$$

We have that  $\text{Tr}^{\mathbb{S}} \circ \text{Smoothing} \circ \text{Bubble}_{\text{one}}(\text{other half})$  is equal to the 2-arrow

$$id(id(2))$$

of  $\text{TL}(\mathbb{S})$ . Hence  $\text{Tr}^{\mathbb{S}} \circ \text{Smoothing} \circ \text{Bubble}_{\text{one}}(\text{other half})$  is equal to the 2-arrow

$$1$$

of  $\mathbb{T}$ .

(2) We have that  $\text{Smoothing} \circ \text{Saddle}_{\text{one}}(\text{one half})$  is equal to the following 2-arrow of  $\text{TL}(\mathbb{S})$ .

$$\begin{aligned} & \left( \left( (A_1^{2,d} \circ_{\text{ver}} A_1^{2,d}) \circ_{\text{hor}} (A_1^{2,d} \circ_{\text{ver}} A_1^{2,d}) \right) \otimes id(id(2)) \right) \\ & \oplus \left( \left( (A_2^{2,d} \circ_{\text{ver}} A_1^{2,d}) \circ_{\text{hor}} (A_2^{2,d} \circ_{\text{ver}} A_1^{2,d}) \right) \otimes (\tau_{\text{UR}} \circ_{\text{hor}} \tau_{\text{UL}}) \right) \\ & \oplus \left( \left( (A_1^{2,d} \circ_{\text{ver}} A_2^{2,d}) \circ_{\text{hor}} (A_1^{2,d} \circ_{\text{ver}} A_2^{2,d}) \right) \otimes (\tau_{\text{LR}} \circ_{\text{hor}} \tau_{\text{LL}}) \right) \\ & \oplus \left( \left( (A_2^{2,d} \circ_{\text{ver}} A_2^{2,d}) \circ_{\text{hor}} (A_2^{2,d} \circ_{\text{ver}} A_2^{2,d}) \right) \otimes \left( (\tau_{\text{UR}} \circ_{\text{ver}} \tau_{\text{LR}}) \circ_{\text{hor}} (\tau_{\text{UL}} \circ_{\text{ver}} \tau_{\text{LL}}) \right) \right) \end{aligned}$$

Hence  $\text{Tr}^{\mathbb{S}} \circ \text{Smoothing} \circ \text{Saddle}_{\text{one}}(\text{one half})$  is equal to the following 2-arrow of  $\mathbb{T}$ .

$$(A_1^{2,d})^4 \oplus \left( (A_1^{2,d})^2 (A_2^{2,d})^2 \oplus (A_1^{2,d})^2 (A_2^{2,d})^2 \right) \gamma^2 \oplus (A_1^{2,d})^4 \gamma^4$$

We have that  $\text{Smoothing} \circ \text{Saddle}_{\text{one}}(\text{other half})$  is equal to the following 2-arrow of  $\text{TL}(\mathbb{S})$ .

$$\begin{aligned} & \left( \left( (A_2^{2,d} \circ_{\text{hor}} A_1^{2,d}) \circ_{\text{hor}} (A_1^{2,d} \circ_{\text{hor}} A_2^{2,d}) \right) \otimes id(id(2)) \right) \\ & \oplus \left( \left( \left( (A_1^{2,d} \circ_{\text{hor}} A_2^{2,d}) \circ_{\text{hor}} (A_1^{2,d} \circ_{\text{ver}} A_2^{2,d}) \right) \oplus \left( (A_2^{2,d} \circ_{\text{hor}} A_1^{2,d}) \circ_{\text{hor}} (A_2^{2,d} \circ_{\text{ver}} A_1^{2,d}) \right) \right) \right. \\ & \left. \otimes (\tau_{\text{UR}} \circ_{\text{hor}} \tau_{\text{LL}}) \right) \\ & \oplus \left( \left( (A_1^{2,d} \circ_{\text{hor}} A_2^{2,d}) \circ_{\text{hor}} (A_2^{2,d} \circ_{\text{ver}} A_1^{2,d}) \right) \otimes \left( (\tau_{\text{UR}} \circ_{\text{hor}} \tau_{\text{LL}}) \circ_{\text{hor}} (\tau_{\text{UR}} \circ_{\text{hor}} \tau_{\text{LL}}) \right) \right) \end{aligned}$$

Hence  $\text{Tr}^{\mathbb{S}} \circ \text{Smoothing} \circ \text{Saddle}_{\text{one}}$  (other half) is equal to the following 2-arrow of  $\mathbb{T}$ .

$$(A_1^{2,d})^2 (A_2^{2,d})^2 \oplus \left( (A_1^{2,d})^2 (A_2^{2,d})^2 \oplus (A_1^{2,d})^2 (A_2^{2,d})^2 \right) \gamma^2 \oplus (A_1^{2,d})^2 (A_2^{2,d})^2 \gamma^4$$

(3) We have that  $\text{Smoothing} \circ \text{Triple}_{\text{one}}$  (one half) is equal to the following 2-arrow of



Hence  $\text{Tr}^{\mathbb{S}} \circ \text{Smoothing} \circ \text{Triple}_{\text{one}}(\text{one half})$  is equal to the following 2-arrow of  $\mathbb{T}$ .

$$\begin{aligned}
& (A_1^{2,d})^4 (A_2^{2,d})^4 (A_1^{2,t})^2 \oplus (A_1^{2,d})^4 (A_2^{2,d})^4 (A_3^{2,t})^2 \gamma^2 \\
& \oplus \left( (A_1^{2,d})^4 (A_2^{2,d})^4 (A_5^{2,t})^2 \oplus (A_1^{2,d})^4 (A_2^{2,d})^4 (A_2^{2,t})^2 \right) \\
& \oplus (A_1^{2,d})^4 (A_2^{2,d})^4 (A_7^{2,t})^2 \oplus (A_1^{2,d})^4 (A_2^{2,d})^4 (A_4^{2,t})^2 \gamma^6 \\
& \oplus \left( (A_1^{2,d})^4 (A_2^{2,d})^4 (A_6^{2,t})^2 \oplus (A_1^{2,d})^4 (A_2^{2,d})^4 (A_8^{2,t})^2 \right) \gamma^{10}
\end{aligned}$$

We have that  $\text{Smoothing} \circ \text{Triple}_{\text{one}}(\text{other half})$  is equal to the following 2-arrow of  $\text{TL}(\mathbb{S})$ .

$$\begin{aligned}
& \left( \left( (A_2^{2,d} \circ_{\text{hor}} A_1^{2,d}) \circ_{\text{hor}} (A_2^{2,d} \circ_{\text{hor}} A_1^{2,d}) \circ_{\text{hor}} (A_2^{2,d} \circ_{\text{hor}} A_1^{2,d}) \right) \otimes id(id(3)) \right) \\
& \oplus \left( \left( \left( (A_1^{2,d} \circ_{\text{hor}} A_2^{2,d}) \circ_{\text{hor}} (A_2^{2,d} \circ_{\text{hor}} A_1^{2,d}) \circ_{\text{hor}} (A_2^{2,d} \circ_{\text{hor}} A_1^{2,d}) \right) \right. \right. \\
& \oplus \left. \left. \left( (A_2^{2,d} \circ_{\text{hor}} A_1^{2,d}) \circ_{\text{hor}} (A_2^{2,d} \circ_{\text{hor}} A_1^{2,d}) \circ_{\text{hor}} (A_1^{2,d} \circ_{\text{hor}} A_2^{2,d}) \right) \right) \right) \\
& \otimes \left( \left( (\tau_{\text{UR}} \otimes_{\text{TL}} 1) \circ_{\text{hor}} (\tau_{\text{LL}} \otimes_{\text{TL}} 1) \right) \right) \\
& \oplus \left( \left( (A_1^{2,d} \circ_{\text{hor}} A_2^{2,d}) \circ_{\text{hor}} (A_1^{2,d} \circ_{\text{hor}} A_2^{2,d}) \circ_{\text{hor}} (A_2^{2,d} \circ_{\text{hor}} A_1^{2,d}) \right) \right. \\
& \otimes \left( \left( (\tau_{\text{UR}} \otimes_{\text{TL}} 1) \circ_{\text{hor}} (\tau_{\text{LL}} \otimes_{\text{TL}} 1) \right) \circ_{\text{hor}} \left( (1 \otimes_{\text{TL}} \tau_{\text{UR}}) \circ_{\text{hor}} (1 \otimes_{\text{TL}} \tau_{\text{LL}}) \right) \right) \\
& \oplus \left( \left( (A_2^{2,d} \circ_{\text{hor}} A_1^{2,d}) \circ_{\text{hor}} (A_1^{2,d} \circ_{\text{hor}} A_2^{2,d}) \circ_{\text{hor}} (A_1^{2,d} \circ_{\text{hor}} A_2^{2,d}) \right) \right. \\
& \otimes \left( \left( (1 \otimes_{\text{TL}} \tau_{\text{UR}}) \circ_{\text{hor}} (1 \otimes_{\text{TL}} \tau_{\text{LL}}) \right) \circ_{\text{hor}} \left( (\tau_{\text{UR}} \otimes_{\text{TL}} 1) \circ_{\text{hor}} (\tau_{\text{LL}} \otimes_{\text{TL}} 1) \right) \right) \\
& \oplus \left( \left( (A_1^{2,d} \circ_{\text{hor}} A_2^{2,d}) \circ_{\text{hor}} (A_1^{2,d} \circ_{\text{hor}} A_2^{2,d}) \circ_{\text{hor}} (A_1^{2,d} \circ_{\text{hor}} A_2^{2,d}) \right) \right. \\
& \otimes \left( \left( (\tau_{\text{UR}} \otimes_{\text{TL}} 1) \circ_{\text{hor}} (\tau_{\text{LL}} \otimes_{\text{TL}} 1) \right) \circ_{\text{hor}} \left( (1 \otimes_{\text{TL}} \tau_{\text{UR}}) \circ_{\text{hor}} (1 \otimes_{\text{TL}} \tau_{\text{LL}}) \right) \right) \\
& \left. \circ_{\text{hor}} \left( (\tau_{\text{UR}} \otimes_{\text{TL}} 1) \circ_{\text{hor}} (\tau_{\text{LL}} \otimes_{\text{TL}} 1) \right) \right)
\end{aligned}$$

Hence  $\text{Tr}^{\mathbb{S}} \circ \text{Smoothing} \circ \text{Triple}_{\text{one}}(\text{other half})$  is equal to the following 2-arrow of  $\mathbb{T}$ .

$$\begin{aligned}
& (A_1^{2,d})^3 (A_2^{2,d})^3 \oplus \left( (A_1^{2,d})^3 (A_2^{2,d})^3 \oplus (A_1^{2,d})^3 (A_2^{2,d})^3 \right) \gamma^2 \\
& \oplus \left( (A_1^{2,d})^3 (A_2^{2,d})^3 \oplus (A_1^{2,d})^3 (A_2^{2,d})^3 \right) \gamma^4 \oplus (A_1^{2,d})^3 (A_2^{2,d})^3 \gamma^6
\end{aligned}$$



Hence  $\text{Tr}^{\mathbb{S}} \circ \text{Smoothing} \circ \text{Triple}_{\text{two}}(\text{one half})$  is equal to the following 2-arrow of  $\mathbb{T}$ .

$$\begin{aligned}
& (A_1^{2,d})^4 (A_2^{2,d})^4 (A_2^{2,t})^2 \oplus (A_1^{2,d})^4 (A_2^{2,d})^4 (A_4^{2,t})^2 \gamma^2 \\
& \oplus \left( (A_1^{2,d})^4 (A_2^{2,d})^4 (A_6^{2,t})^2 \oplus (A_1^{2,d})^4 (A_2^{2,d})^4 (A_1^{2,t})^2 \right) \\
& \oplus (A_1^{2,d})^4 (A_2^{2,d})^4 (A_8^{2,t})^2 \oplus (A_1^{2,d})^4 (A_2^{2,d})^4 (A_3^{2,t})^2 \gamma^6 \\
& \oplus \left( (A_1^{2,d})^4 (A_2^{2,d})^4 (A_5^{2,t})^2 \oplus (A_1^{2,d})^4 (A_2^{2,d})^4 (A_7^{2,t})^2 \right) \gamma^{10}
\end{aligned}$$

We have that  $\text{Smoothing} \circ \text{Triple}_{\text{two}}(\text{other half})$  is equal to the following 2-arrow of  $\text{TL}(\mathbb{S})$ .

$$\begin{aligned}
& \left( \left( (A_2^{2,d} \circ_{\text{hor}} A_1^{2,d}) \circ_{\text{hor}} (A_2^{2,d} \circ_{\text{hor}} A_1^{2,d}) \circ_{\text{hor}} (A_1^{2,d} \circ_{\text{hor}} A_2^{2,d}) \right) \otimes \text{id}(\text{id}(3)) \right) \\
& \oplus \left( \left( \left( (A_1^{2,d} \circ_{\text{hor}} A_2^{2,d}) \circ_{\text{hor}} (A_2^{2,d} \circ_{\text{hor}} A_1^{2,d}) \circ_{\text{hor}} (A_1^{2,d} \circ_{\text{hor}} A_2^{2,d}) \right) \right. \right. \\
& \oplus \left. \left( (A_2^{2,d} \circ_{\text{hor}} A_1^{2,d}) \circ_{\text{hor}} (A_2^{2,d} \circ_{\text{hor}} A_1^{2,d}) \circ_{\text{hor}} (A_2^{2,d} \circ_{\text{hor}} A_1^{2,d}) \right) \right) \\
& \otimes \left( \left( (\tau_{\text{UR}} \otimes_{\text{TL}} 1) \circ_{\text{hor}} (\tau_{\text{LL}} \otimes_{\text{TL}} 1) \right) \right) \\
& \oplus \left( \left( (A_1^{2,d} \circ_{\text{hor}} A_2^{2,d}) \circ_{\text{hor}} (A_1^{2,d} \circ_{\text{hor}} A_2^{2,d}) \circ_{\text{hor}} (A_1^{2,d} \circ_{\text{hor}} A_2^{2,d}) \right) \right. \\
& \otimes \left( \left( (\tau_{\text{UR}} \otimes_{\text{TL}} 1) \circ_{\text{hor}} (\tau_{\text{LL}} \otimes_{\text{TL}} 1) \right) \circ_{\text{hor}} \left( (1 \otimes_{\text{TL}} \tau_{\text{UR}}) \circ_{\text{hor}} (1 \otimes_{\text{TL}} \tau_{\text{LL}}) \right) \right) \\
& \oplus \left( \left( (A_2^{2,d} \circ_{\text{hor}} A_1^{2,d}) \circ_{\text{hor}} (A_1^{2,d} \circ_{\text{hor}} A_2^{2,d}) \circ_{\text{hor}} (A_2^{2,d} \circ_{\text{hor}} A_1^{2,d}) \right) \right. \\
& \otimes \left( \left( (1 \otimes_{\text{TL}} \tau_{\text{UR}}) \circ_{\text{hor}} (1 \otimes_{\text{TL}} \tau_{\text{LL}}) \right) \circ_{\text{hor}} \left( (\tau_{\text{UR}} \otimes_{\text{TL}} 1) \circ_{\text{hor}} (\tau_{\text{LL}} \otimes_{\text{TL}} 1) \right) \right) \\
& \oplus \left( \left( (A_1^{2,d} \circ_{\text{hor}} A_2^{2,d}) \circ_{\text{hor}} (A_1^{2,d} \circ_{\text{hor}} A_2^{2,d}) \circ_{\text{hor}} (A_2^{2,d} \circ_{\text{hor}} A_1^{2,d}) \right) \right. \\
& \otimes \left( \left( (\tau_{\text{UR}} \otimes_{\text{TL}} 1) \circ_{\text{hor}} (\tau_{\text{LL}} \otimes_{\text{TL}} 1) \right) \circ_{\text{hor}} \left( (1 \otimes_{\text{TL}} \tau_{\text{UR}}) \circ_{\text{hor}} (1 \otimes_{\text{TL}} \tau_{\text{LL}}) \right) \right) \\
& \left. \circ_{\text{hor}} \left( (\tau_{\text{UR}} \otimes_{\text{TL}} 1) \circ_{\text{hor}} (\tau_{\text{LL}} \otimes_{\text{TL}} 1) \right) \right)
\end{aligned}$$

Hence  $\text{Tr}^{\mathbb{S}} \circ \text{Smoothing} \circ \text{Triple}_{\text{two}}(\text{other half})$  is equal to the following 2-arrow of  $\mathbb{T}$ .

$$\begin{aligned}
& (A_1^{2,d})^3 (A_2^{2,d})^3 \oplus \left( (A_1^{2,d})^3 (A_2^{2,d})^3 \oplus (A_1^{2,d})^3 (A_2^{2,d})^3 \right) \gamma^2 \\
& \oplus \left( (A_1^{2,d})^3 (A_2^{2,d})^3 \oplus (A_1^{2,d})^3 (A_2^{2,d})^3 \right) \gamma^4 \oplus (A_1^{2,d})^3 (A_2^{2,d})^3 \gamma^6
\end{aligned}$$





Hence  $\text{Tr}^{\mathbb{S}} \circ \text{Smoothing} \circ \text{Triple}_{\text{three}}$  (one half) is equal to the following 2-arrow of  $\mathbb{T}$ .

$$\begin{aligned}
& (A_1^{2,d})^4 (A_2^{2,d})^4 (A_5^{2,t})^2 \oplus (A_1^{2,d})^4 (A_2^{2,d})^4 (A_7^{2,t})^2 \gamma^2 \\
& \oplus \left( (A_1^{2,d})^4 (A_2^{2,d})^4 (A_1^{2,t})^2 \oplus (A_1^{2,d})^4 (A_2^{2,d})^4 (A_6^{2,t})^2 \right. \\
& \oplus (A_1^{2,d})^4 (A_2^{2,d})^4 (A_3^{2,t})^2 \oplus (A_1^{2,d})^4 (A_2^{2,d})^4 (A_8^{2,t})^2 \left. \right) \gamma^6 \\
& \oplus \left( (A_1^{2,d})^4 (A_2^{2,d})^4 (A_2^{2,t})^2 \oplus (A_1^{2,d})^4 (A_2^{2,d})^4 (A_4^{2,t})^2 \right) \gamma^{10}
\end{aligned}$$

We have that  $\text{Smoothing} \circ \text{Triple}_{\text{three}}$  (other half) is equal to the following 2-arrow of  $\text{TL}(\mathbb{S})$ .

$$\begin{aligned}
& \left( \left( (A_1^{2,d} \circ_{\text{hor}} A_2^{2,d}) \circ_{\text{hor}} (A_2^{2,d} \circ_{\text{hor}} A_1^{2,d}) \circ_{\text{hor}} (A_2^{2,d} \circ_{\text{hor}} A_1^{2,d}) \right) \otimes id(id(3)) \right) \\
& \oplus \left( \left( \left( (A_2^{2,d} \circ_{\text{hor}} A_1^{2,d}) \circ_{\text{hor}} (A_2^{2,d} \circ_{\text{hor}} A_1^{2,d}) \circ_{\text{hor}} (A_2^{2,d} \circ_{\text{hor}} A_1^{2,d}) \right) \right. \right. \\
& \oplus \left. \left. (A_1^{2,d} \circ_{\text{hor}} A_2^{2,d}) \circ_{\text{hor}} (A_2^{2,d} \circ_{\text{hor}} A_1^{2,d}) \circ_{\text{hor}} (A_1^{2,d} \circ_{\text{hor}} A_2^{2,d}) \right) \right) \\
& \otimes \left( \left( (\tau_{\text{UR}} \otimes_{\text{TL}} 1) \circ_{\text{hor}} (\tau_{\text{LL}} \otimes_{\text{TL}} 1) \right) \right) \\
& \oplus \left( \left( (A_2^{2,d} \circ_{\text{hor}} A_1^{2,d}) \circ_{\text{hor}} (A_1^{2,d} \circ_{\text{hor}} A_2^{2,d}) \circ_{\text{hor}} (A_2^{2,d} \circ_{\text{hor}} A_1^{2,d}) \right) \right. \\
& \otimes \left( \left( (\tau_{\text{UR}} \otimes_{\text{TL}} 1) \circ_{\text{hor}} (\tau_{\text{LL}} \otimes_{\text{TL}} 1) \right) \circ_{\text{hor}} \left( (1 \otimes_{\text{TL}} \tau_{\text{UR}}) \circ_{\text{hor}} (1 \otimes_{\text{TL}} \tau_{\text{LL}}) \right) \right) \\
& \oplus \left( \left( (A_1^{2,d} \circ_{\text{hor}} A_2^{2,d}) \circ_{\text{hor}} (A_1^{2,d} \circ_{\text{hor}} A_2^{2,d}) \circ_{\text{hor}} (A_1^{2,d} \circ_{\text{hor}} A_2^{2,d}) \right) \right. \\
& \otimes \left( \left( (1 \otimes_{\text{TL}} \tau_{\text{UR}}) \circ_{\text{hor}} (1 \otimes_{\text{TL}} \tau_{\text{LL}}) \right) \circ_{\text{hor}} \left( (\tau_{\text{UR}} \otimes_{\text{TL}} 1) \circ_{\text{hor}} (\tau_{\text{LL}} \otimes_{\text{TL}} 1) \right) \right) \\
& \oplus \left( \left( (A_2^{2,d} \circ_{\text{hor}} A_1^{2,d}) \circ_{\text{hor}} (A_1^{2,d} \circ_{\text{hor}} A_2^{2,d}) \circ_{\text{hor}} (A_1^{2,d} \circ_{\text{hor}} A_2^{2,d}) \right) \right. \\
& \otimes \left( \left( (\tau_{\text{UR}} \otimes_{\text{TL}} 1) \circ_{\text{hor}} (\tau_{\text{LL}} \otimes_{\text{TL}} 1) \right) \circ_{\text{hor}} \left( (1 \otimes_{\text{TL}} \tau_{\text{UR}}) \circ_{\text{hor}} (1 \otimes_{\text{TL}} \tau_{\text{LL}}) \right) \right. \\
& \left. \left. \circ_{\text{hor}} \left( (\tau_{\text{UR}} \otimes_{\text{TL}} 1) \circ_{\text{hor}} (\tau_{\text{LL}} \otimes_{\text{TL}} 1) \right) \right) \right)
\end{aligned}$$

Hence  $\text{Tr}^{\mathbb{S}} \circ \text{Smoothing} \circ \text{Triple}_{\text{three}}$  (other half) is equal to the following 2-arrow of  $\mathbb{T}$ .

$$\begin{aligned}
& (A_1^{2,d})^3 (A_2^{2,d})^3 \oplus \left( (A_1^{2,d})^3 (A_2^{2,d})^3 \oplus (A_1^{2,d})^3 (A_2^{2,d})^3 \right) \gamma^2 \\
& \oplus \left( (A_1^{2,d})^3 (A_2^{2,d})^3 \oplus (A_1^{2,d})^3 (A_2^{2,d})^3 \right) \gamma^4 \oplus (A_1^{2,d})^3 (A_2^{2,d})^3 \gamma^6
\end{aligned}$$



---

---

# APPENDIX A

---

## APPENDIX

## A.1. Synthetic category theory

In Chapter 3, we make use of various constructions in  $\mathbf{Cat}$ , the category of categories. In fact, our work can be thought of as carried out in a *synthetic* theory of the category of categories, namely in a formal language, such as a flavour of type theory, in which various fundamental category theoretic notions are taken as primitive, and rules are given which allow one to carry out various category theoretic constructions. In particular, it can be carried out in any category admitting the same constructions as  $\mathbf{Cat}$ .

In this section, we outline informally those synthetic constructions and assumptions governing  $\mathbf{Cat}$  that we have in mind. We take as given, as we do throughout this work, a meta-category theory allowing us to express those categorical notions we require. This meta-category theory is, from a foundational point of view, constructive in a very strong sense, and predicative. We assume that it has a notion of equality of functors that is reflexive, symmetric, and transitive, as usual for such a notion. It is only in Chapter 2 that we shall make use of our meta-category theory beyond the use of it that we make in this appendix. In Chapter 3 we work entirely with  $\mathbf{Cat}$ , whilst in Chapter 4 we work entirely with  $2\text{-Cat}$ , which we shall discuss in the next section.

**Terminology A.1.1.1.** We refer to an object of  $\mathbf{Cat}$  as a *category*.

**Remark A.1.1.2.** In this section, when we refer to a category, we shall always mean a category in this sense, rather than in the sense of our meta-category theory. Elsewhere in this work, it will always be clear from the context which sense we have in mind.

**Terminology A.1.1.3.** We refer to an arrow of  $\mathbf{Cat}$  as a *functor*.

**Remark A.1.1.4.** We adopt the same convention when referring to functors as that described in Remark A.1.1.2 when referring to categories.

**Assumption A.1.1.5.** There is a category  $1$ , which is a final object of  $\mathbf{Cat}$ .

**Terminology A.1.1.6.** Let  $\mathcal{A}$  be a category. We refer to a functor

$$1 \longrightarrow \mathcal{A}$$

as an *object* of  $\mathcal{A}$ .

**Assumption A.1.1.7.** There is a category  $\mathcal{I}$ , together with a functor

$$1 \xrightarrow{0} \mathcal{I}$$

and a functor

$$1 \xrightarrow{1} \mathcal{I}.$$

**Terminology A.1.1.8.** Let  $\mathcal{A}$  be a category. We refer to a functor

$$\mathcal{I} \longrightarrow \mathcal{A}$$

as an *arrow* of  $\mathcal{A}$ .

**Terminology A.1.1.9.** Let  $\mathcal{A}$  be a category. Let

$$\mathcal{I} \xrightarrow{f} \mathcal{A}$$

be an arrow of  $\mathcal{A}$ . We refer to the object of  $\mathcal{A}$  given by

$$1 \xrightarrow{f \circ 0} \mathcal{I}$$

as the *source* of  $f$ . We refer to the object of  $\mathcal{A}$  given by

$$1 \xrightarrow{f \circ 1} \mathcal{I}$$

as the *target* of  $f$ .

**Notation A.1.1.10.** Let  $\mathcal{A}$  be a category. Let  $f$  be an arrow of  $\mathcal{A}$ . Let  $a_0$  denote the source of  $f$ , and let  $a_1$  denote the target of  $f$ . We often denote  $f$  as follows.

$$a_0 \xrightarrow{f} a_1$$

**Assumption A.1.1.11.** There is a diagram

$$\begin{array}{ccc} 1 & \xrightarrow{0} & \mathcal{I} \\ \downarrow 1 & & \downarrow r_0^{\mathcal{I}_0 \sqcup_1 \mathcal{I}} \\ \mathcal{I} & \xrightarrow{r_1^{\mathcal{I}_0 \sqcup_1 \mathcal{I}}} & \mathcal{I}_0 \sqcup_1 \mathcal{I} \end{array}$$

in  $\mathbf{Cat}$  which defines a co-cartesian square.

**Assumption A.1.1.12.** The category  $\mathcal{I}_0 \sqcup_1 \mathcal{I}$  has an arrow  $s$  such that the diagrams

$$\begin{array}{ccc} 1 & \xrightarrow{0} & \mathcal{I} \\ \downarrow 0 & & \downarrow s \\ \mathcal{I} & \xrightarrow{r_1^{\mathcal{I}_0 \sqcup_1 \mathcal{I}}} & \mathcal{I}_0 \sqcup_1 \mathcal{I} \end{array}$$

and

$$\begin{array}{ccc}
 1 & \xrightarrow{1} & \mathcal{I} \\
 0 \downarrow & & \downarrow s \\
 \mathcal{I} & \xrightarrow{r_0^{\mathcal{I}_0 \sqcup_1 \mathcal{I}}} & \mathcal{I}_0 \sqcup_1 \mathcal{I}
 \end{array}$$

in  $\mathbf{Cat}$  commute.

**Notation A.1.1.13.** Let  $\mathcal{A}$  be a category. Let  $f$  and  $g$  be arrows of  $\mathcal{A}$  such that the source of  $g$  is equal to the target of  $f$ . In other words, the following diagram in  $\mathbf{Cat}$  commutes.

$$\begin{array}{ccc}
 1 & \xrightarrow{0} & \mathcal{I} \\
 1 \downarrow & & \downarrow g \\
 \mathcal{I} & \xrightarrow{f} & \mathcal{A}
 \end{array}$$

We denote by  $g \circ f$  the canonical functor such that the following diagram in  $\mathbf{Cat}$  commutes.

$$\begin{array}{ccc}
 1 & \xrightarrow{0} & \mathcal{I} \\
 1 \downarrow & & \downarrow r_0^{\mathcal{I}_0 \sqcup_1 \mathcal{I}} \\
 \mathcal{I} & \xrightarrow{r_1^{\mathcal{I}_0 \sqcup_1 \mathcal{I}}} & \mathcal{I}_0 \sqcup_1 \mathcal{I} \\
 & & \downarrow g \circ f \\
 & & \mathcal{A}
 \end{array}$$

$f$  (curved arrow from  $\mathcal{I}$  to  $\mathcal{A}$ ) and  $g$  (curved arrow from  $\mathcal{I}$  to  $\mathcal{A}$ )

**Remark A.1.1.14.** It follows immediately from the definition of  $g \circ f$  that the source of  $g \circ f$  is equal to the source of  $f$ , and that the target of  $g \circ f$  is equal to the target of  $g$ .

**Terminology A.1.1.15.** Let  $\mathcal{A}$  be a category. Let  $f$  and  $g$  be arrows of  $\mathcal{A}$  such that the source of  $g$  is equal to the target of  $f$ . We refer to the arrow  $g \circ f$  of  $\mathcal{A}$  as the *composition* of  $f$  and  $g$ .

**Remark A.1.1.16.** Let  $\mathcal{A}$  be a category. Let  $f_0$  and  $g_0$  be arrows of  $\mathcal{A}$  such that the source of  $g_0$  is equal to the target of  $f_0$ . Let  $f_1$  and  $g_1$  be arrows of  $\mathcal{A}$  such that the source of  $g_1$  is equal to the target of  $f_1$ . Suppose that  $f_0$  is equal to  $f_1$ , and that  $g_0$  is

equal to  $g_1$ . It follows immediately from the universal property of  $\mathcal{I} \circ \sqcup_1 \mathcal{I}$  that  $g_1 \circ f_1$  is equal to  $g_0 \circ f_0$ .

**Assumption A.1.1.17.** Let  $\mathcal{A}$  be a category. Composition of arrows of  $\mathcal{A}$  is associative. In other words, given arrows  $f$ ,  $g$ , and  $h$  of  $\mathcal{A}$  such that the source of  $g$  is equal to the target of  $f$ , and the source of  $h$  is equal to the target of  $g$ , then  $(h \circ g) \circ f$  is equal to  $h \circ (g \circ f)$ .

**Remark A.1.1.18.** We shall implicitly make use of Assumption A.1.1.17 throughout this work, without further mention, by omitting parentheses when we work with compositions of three or more arrows of a category.

**Assumption A.1.1.19.** Let  $\mathcal{A}$  be a category. Let  $a$  be an object of  $\mathcal{A}$ . There is an arrow of  $\mathcal{A}$  whose source is  $a$ , and whose target is  $a$ .

**Terminology A.1.1.20.** Let  $\mathcal{A}$  be a category. Let  $a$  be an object of  $\mathcal{A}$ . We refer to the arrow  $id(a)$  of  $\mathcal{A}$  to which the rule of Assumption A.1.1.19 gives rise as the *identity arrow* with respect to  $a$ .

**Notation A.1.1.21.** Let  $\mathcal{A}$  be a category. Let  $a$  be an object of  $\mathcal{A}$ . We denote the identity arrow with respect to  $a$  by  $id(a)$ .

**Remark A.1.1.22.** Let  $\mathcal{A}$  be a category. Let  $a$  be an object of  $\mathcal{A}$ . Appealing to the universal property of  $1$ , an arrow whose source is  $a$  and whose target is  $a$  can be constructed, such that Assumption A.1.1.25 holds. Since we shall not make use of this specific construction, we prefer to take the rule of Assumption A.1.1.19 as primitive.

**Assumption A.1.1.23.** Let  $\mathcal{A}$  be a category. Let

$$a_0 \xrightarrow{f} a_1$$

be an arrow of  $\mathcal{A}$ . Then  $f \circ id(a_0)$  is equal to  $f$ .

**Assumption A.1.1.24.** Let  $\mathcal{A}$  be a category. Let

$$a_0 \xrightarrow{f} a_1$$

be an arrow of  $\mathcal{A}$ . Then  $id(a_1) \circ f$  is equal to  $f$ .

**Assumption A.1.1.25.** Let  $\mathcal{A}$  be a category. Let  $a_0$  and  $a_1$  be objects of  $\mathcal{A}$ . Suppose that  $a_0$  is equal to  $a_1$ . Then  $id(a_0)$  is equal to  $id(a_1)$ .

**Assumption A.1.1.26.** There is an object  $\partial\mathcal{I}$  of  $\text{Cat}$ .

**Assumption A.1.1.27.** Let  $\mathcal{A}$  be a category. Given a pair of objects of  $\mathcal{A}$ , there is a functor

$$\partial\mathcal{I} \longrightarrow \mathcal{A}.$$



**Remark A.1.1.28.** If we assume that there is a coproduct of two copies of 1 and 1 in  $\mathbf{Cat}$ , then an object of  $\mathbf{Cat}$  with the property of  $\partial\mathcal{I}$  can be constructed, and hence Assumption A.1.1.27 is not necessary. However, we prefer to make Assumption A.1.1.27 in any case, as we shall only appeal directly to the rule it introduces.

**Assumption A.1.1.29.** Let  $\mathcal{A}$  be a category. Let  $a_0, a_1, a_2,$  and  $a_3$  be objects of  $\mathcal{A}$ . Let

$$\partial\mathcal{I} \xrightarrow{f} \mathcal{A}$$

be the functor determined by  $a_0$  and  $a_1$  by means of the rule of Assumption A.1.1.27. Let

$$\partial\mathcal{I} \xrightarrow{g} \mathcal{A}$$

be the functor determined by  $a_2$  and  $a_3$  by means of the rule of Assumption A.1.1.27. Suppose that  $a_0$  is equal to  $a_2$ , and that  $a_1$  is equal to  $a_3$ . Then  $f$  is equal to  $g$ .

**Assumption A.1.1.30.** The category  $\mathbf{Cat}$  has those finite coproducts, coequalisers, and pushouts that we make use of in this work.

**Assumption A.1.1.31.** The category  $\mathbf{Cat}$  has those finite products which we make use of in this work.

## A.2. Synthetic cubical 2-category theory

In Chapter 4, we make use of various constructions in the category  $\mathbf{2-Cat}$  of cubical 2-categories. Just as our work with  $\mathbf{Cat}$  can, as discussed in §A.1, be thought of as carried out synthetically, so our work with  $\mathbf{2-Cat}$  can be thought of as carried out in a *synthetic* theory of the category of cubical 2-categories. In particular, it can be carried out in any category admitting the same constructions as *twocat*.

In this section, we outline informally those synthetic constructions and assumptions governing  $\mathbf{2-Cat}$  that we have in mind. We take as given the same meta-category theory as mentioned at the beginning of §A.1. By a 2-category, we shall always mean a *strict* 2-category.

Cubical 2-categories are also known as *edge-symmetric double categories*. The notion of a cubical 2-category differs from that of a globular 2-category, the latter being by far the better known of the two, in that the 2-arrows are thought of as squares rather than as globes. A globular 2-category can be viewed as a cubical 2-category in which all squares have identity vertical (say) arrows.

Nevertheless, if one assumes cubical 2-categories to be equipped with a little more structure than we do here, that of connections, then the category of cubical 2-categories is in fact equivalent to the category of globular 2-categories, as demonstrated for

instance in the paper [2] of Brown and Mosa. However, depending on the purpose to which they are put, one of the two notions can be much more natural than the other. As we explain elsewhere in this work, we regard the use of cubical rather than globular 2-categories as essential to the framework of Chapter 4.

**Terminology A.1.2.1.** We refer to an object of  $2\text{-Cat}$  as a *cubical 2-category*.

**Terminology A.1.2.2.** We refer to an arrow of  $2\text{-Cat}$  as a *functor*.

**Remark A.1.2.3.** Arrows of  $2\text{-Cat}$  are also sometimes known as 2-functors, or strict 2-functors.

**Assumption A.1.2.4.** There is a cubical 2-category  $1$ , which is a final object of  $2\text{-Cat}$ .

**Terminology A.1.2.5.** Let  $\mathcal{A}$  be a cubical 2-category. We refer to a functor

$$1 \longrightarrow \mathcal{A}$$

as an *object* of  $\mathcal{A}$ .

**Assumption A.1.2.6.** There is a cubical 2-category  $\mathcal{I}$ , together with a functor

$$1 \xrightarrow{0} \mathcal{I}$$

and a functor

$$1 \xrightarrow{1} \mathcal{I}.$$

**Terminology A.1.2.7.** Let  $\mathcal{A}$  be a cubical 2-category. We refer to a functor

$$\mathcal{I} \longrightarrow \mathcal{A}$$

as a *1-arrow* of  $\mathcal{A}$ .

**Terminology A.1.2.8.** Let  $\mathcal{A}$  be a cubical 2-category. Let

$$\mathcal{I} \xrightarrow{f} \mathcal{A}$$

be a 1-arrow of  $\mathcal{A}$ . We refer to the object of  $\mathcal{A}$  given by

$$1 \xrightarrow{f \circ 0} \mathcal{I}$$

as the *source* of  $f$ . We refer to the object of  $\mathcal{A}$  given by

$$1 \xrightarrow{f \circ 1} \mathcal{I}$$

as the *target* of  $f$ .

**Notation A.1.2.9.** Let  $\mathcal{A}$  be a cubical 2-category. Let  $f$  be a 1-arrow of  $\mathcal{A}$ . Let  $a_0$  denote the source of  $f$ , and let  $a_1$  denote the target of  $f$ . We often denote  $f$  as follows.

$$a_0 \xrightarrow{f} a_1$$

**Assumption A.1.2.10.** There is a diagram

$$\begin{array}{ccc} 1 & \xrightarrow{0} & \mathcal{I} \\ \downarrow 1 & & \downarrow r_0^{\mathcal{I}_0 \sqcup_1 \mathcal{I}} \\ \mathcal{I} & \xrightarrow{r_1^{\mathcal{I}_0 \sqcup_1 \mathcal{I}}} & \mathcal{I}_0 \sqcup_1 \mathcal{I} \end{array}$$

in  $2\text{-Cat}$  which defines a co-cartesian square.

**Assumption A.1.2.11.** The cubical 2-category  $\mathcal{I}_0 \sqcup_1 \mathcal{I}$  has a 1-arrow  $s$  such that the diagrams

$$\begin{array}{ccc} 1 & \xrightarrow{0} & \mathcal{I} \\ \downarrow 0 & & \downarrow s \\ \mathcal{I} & \xrightarrow{r_1^{\mathcal{I}_0 \sqcup_1 \mathcal{I}}} & \mathcal{I}_0 \sqcup_1 \mathcal{I} \end{array}$$

and

$$\begin{array}{ccc} 1 & \xrightarrow{1} & \mathcal{I} \\ \downarrow 1 & & \downarrow s \\ \mathcal{I} & \xrightarrow{r_0^{\mathcal{I}_0 \sqcup_1 \mathcal{I}}} & \mathcal{I}_0 \sqcup_1 \mathcal{I} \end{array}$$

in  $2\text{-Cat}$  commute.

**Notation A.1.2.12.** Let  $\mathcal{A}$  be a cubical 2-category. Let  $f$  and  $g$  be 1-arrows of  $\mathcal{A}$  such that the source of  $g$  is equal to the target of  $f$ . In other words, the following diagram in  $2\text{-Cat}$  commutes.

$$\begin{array}{ccc} 1 & \xrightarrow{0} & \mathcal{I} \\ \downarrow 1 & & \downarrow g \\ \mathcal{I} & \xrightarrow{f} & \mathcal{A} \end{array}$$

We denote by  $g \circ f$  the canonical functor such that the following diagram in 2-Cat commutes.

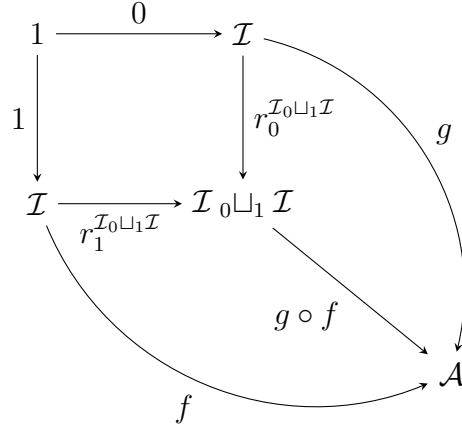

**Remark A.1.2.13.** It follows immediately from the definition of  $g \circ f$  that the source of  $g \circ f$  is equal to the source of  $f$ , and that the target of  $g \circ f$  is equal to the target of  $g$ .

**Terminology A.1.2.14.** Let  $\mathcal{A}$  be a cubical 2-category. Let  $f$  and  $g$  be 1-arrows of  $\mathcal{A}$  such that the source of  $g$  is equal to the target of  $f$ . We refer to the 1-arrow  $g \circ f$  of  $\mathcal{A}$  as the *composition* of  $f$  and  $g$ .

**Remark A.1.2.15.** Let  $\mathcal{A}$  be a cubical 2-category. Let  $f_0$  and  $g_0$  be 1-arrows of  $\mathcal{A}$  such that the source of  $g_0$  is equal to the target of  $f_0$ . Let  $f_1$  and  $g_1$  be 1-arrows of  $\mathcal{A}$  such that the source of  $g_1$  is equal to the target of  $f_1$ . Suppose that  $f_0$  is equal to  $f_1$ , and that  $g_0$  is equal to  $g_1$ . It follows immediately from the universal property of  $\mathcal{I}_0 \sqcup_1 \mathcal{I}$  that  $g_1 \circ f_1$  is equal to  $g_0 \circ f_0$ .

**Assumption A.1.2.16.** Let  $\mathcal{A}$  be a cubical 2-category. Then composition of 1-arrows of  $\mathcal{A}$  is associative. In other words, given 1-arrows  $f$ ,  $g$ , and  $h$  of  $\mathcal{A}$  such that the source of  $g$  is equal to the target of  $f$ , and the source of  $h$  is equal to the target of  $g$ , then  $(h \circ g) \circ f$  is equal to  $h \circ (g \circ f)$ .

**Remark A.1.2.17.** We shall implicitly make use of Assumption A.1.2.16 throughout this work, without further mention, by omitting parentheses when we work with compositions of three or more arrows of a cubical 2-category.

**Notation A.1.2.18.** Let  $\mathcal{A}$  be a cubical 2-category. Let  $a$  be an object of  $\mathcal{A}$ . Let  $p$  denote the canonical functor

$$\mathcal{I} \longrightarrow 1$$

to which the universal property of 1 gives rise. We denote the 1-arrow

$$\mathcal{I} \xrightarrow{a \circ p} \mathcal{A}$$

of  $\mathcal{A}$  by  $id(a)$ .

**Terminology A.1.2.19.** Let  $\mathcal{A}$  be a cubical 2-category. Let  $a$  be an object of  $\mathcal{A}$ . We refer to the 1-arrow  $id(a)$  of  $\mathcal{A}$  as the *identity 1-arrow* with respect to  $a$ .

**Remark A.1.2.20.** It follows immediately from the definition of  $id(a)$ , appealing to the universal property of 1, that the source of  $id(a)$  is  $a$ , and that the target of  $id(a)$  is  $a$ .

**Assumption A.1.2.21.** Let  $\mathcal{A}$  be a cubical 2-category. Let

$$a_0 \xrightarrow{f} a_1$$

be a 1-arrow of  $\mathcal{A}$ . Then  $f \circ id(a_0)$  is equal to  $f$ .

**Assumption A.1.2.22.** Let  $\mathcal{A}$  be a cubical 2-category. Let

$$a_0 \xrightarrow{f} a_1$$

be a 1-arrow of  $\mathcal{A}$ . Then  $id(a_1) \circ f$  is equal to  $f$ .

**Assumption A.1.2.23.** Let  $\mathcal{A}$  be a cubical 2-category. Let  $a_0$  and  $a_1$  be objects of  $\mathcal{A}$ . Suppose that  $a_0$  is equal to  $a_1$ . Then  $id(a_0)$  is equal to  $id(a_1)$ .

**Assumption A.1.2.24.** There is an object  $\partial\mathcal{I}$  of 2-Cat.

**Assumption A.1.2.25.** Let  $\mathcal{A}$  be a cubical 2-category. Given a pair of objects of  $\mathcal{A}$ , there is a functor

$$\partial\mathcal{I} \longrightarrow \mathcal{A}.$$

**Remark A.1.2.26.** If we assume that there is a coproduct of two copies of 1 and 1 in 2-Cat, then an object of 2-Cat with the property of  $\partial\mathcal{I}$  can be constructed, and hence Assumption A.1.2.25 is not necessary. However, we prefer to make Assumption A.1.2.25 in any case, in order to be able to appeal directly to the rule it introduces.

**Assumption A.1.2.27.** Let  $\mathcal{A}$  be a cubical 2-category. Let  $a_0, a_1, a_2,$  and  $a_3$  be objects of  $\mathcal{A}$ . Let

$$\partial\mathcal{I} \xrightarrow{f} \mathcal{A}$$

be the functor determined by  $a_0$  and  $a_1$  by means of the rule of Assumption A.1.2.25. Let

$$\partial\mathcal{I} \xrightarrow{g} \mathcal{A}$$

be the functor determined by  $a_2$  and  $a_3$  by means of the rule of Assumption A.1.2.25. Suppose that  $a_0$  is equal to  $a_2$ , and that  $a_1$  is equal to  $a_3$ . Then  $f$  is equal to  $g$ .

**Remark A.1.2.28.** Thus far, our synthetic theory of 2-Cat is identical, up to a couple of changes of terminology, to the our synthetic theory of Cat. Thus, appealing to Assumption A.1.2.71, any construction which can be carried out in Cat can be carried out in 2-Cat.

**Assumption A.1.2.29.** There is a cubical 2-category  $\mathcal{S}$ , together with four functors

$$1 \longrightarrow \mathcal{S},$$

which we denote by  $\mathbf{nw}$ ,  $\mathbf{ne}$ ,  $\mathbf{sw}$ , and  $\mathbf{se}$ , and four functors

$$\mathcal{I} \longrightarrow \mathcal{S},$$

which we denote by  $\mathbf{n}$ ,  $\mathbf{s}$ ,  $\mathbf{w}$ , and  $\mathbf{e}$ , and whose sources and targets satisfy those equalities which allow us to depict these 1-arrows as follows.

$$\begin{array}{ccc} \mathbf{nw} & \xrightarrow{\mathbf{n}} & \mathbf{ne} \\ \mathbf{w} \downarrow & & \downarrow \mathbf{e} \\ \mathbf{sw} & \xrightarrow{\mathbf{s}} & \mathbf{se} \end{array}$$

**Terminology A.1.2.30.** Let  $\mathcal{A}$  be a cubical 2-category. We refer to a functor

$$\mathcal{S} \longrightarrow \mathcal{A}$$

as a *2-arrow* of  $\mathcal{A}$ .

**Terminology A.1.2.31.** Let  $\mathcal{A}$  be a cubical 2-category. Let  $\sigma$  be a 2-arrow of  $\mathcal{A}$ . We refer to the 1-arrow

$$\mathcal{I} \xrightarrow{\sigma \circ \mathbf{n}} \mathcal{A}$$

as the *north face* of  $\sigma$ . We refer to the 1-arrow

$$\mathcal{I} \xrightarrow{\sigma \circ \mathbf{e}} \mathcal{A}$$

as the *east face* of  $\sigma$ . We refer to the 1-arrow

$$\mathcal{I} \xrightarrow{\sigma \circ \mathbf{w}} \mathcal{A}$$

as the *west face* of  $\sigma$ . We refer to the 1-arrow

$$\mathcal{I} \xrightarrow{\sigma \circ \mathbf{s}} \mathcal{A}$$

as the *south face* of  $\sigma$ .

**Notation A.1.2.32.** Let  $\mathcal{A}$  be a cubical 2-category. Let

$$\mathcal{S} \xrightarrow{\sigma} \mathcal{A}$$

be a 2-arrow of  $\mathcal{A}$ . Let  $a_0, a_1, a_2,$  and  $a_3$  be objects of  $\mathcal{A}$ , and let  $f_0, f_1, f_2,$  and  $f_3$  be 1-arrows of  $\mathcal{A}$  whose sources and targets satisfy those equalities which allow us to depict them as follows.

$$\begin{array}{ccc} a_0 & \xrightarrow{f_0} & a_1 \\ f_2 \downarrow & & \downarrow f_1 \\ a_2 & \xrightarrow{f_3} & a_3 \end{array}$$

Suppose that the north face of  $\sigma$  is equal to  $f_0$ , that the east face of  $\sigma$  is equal to  $f_1$ , that the west face of  $\sigma$  is equal to  $f_2$ , and that the south face of  $\sigma$  is equal to  $f_3$ . We then depict  $\sigma$  as follows.

$$\begin{array}{ccc} a_0 & \xrightarrow{f_0} & a_1 \\ f_2 \downarrow & \sigma & \downarrow f_1 \\ a_2 & \xrightarrow{f_3} & a_3 \end{array}$$

**Assumption A.1.2.33.** There is a diagram

$$\begin{array}{ccc} \mathcal{I} & \xrightarrow{\mathbf{n}} & \mathcal{S} \\ \mathbf{s} \downarrow & & \downarrow r_0^{\mathcal{S}_n \sqcup_s \mathcal{S}} \\ \mathcal{S} & \xrightarrow{r_1^{\mathcal{S}_n \sqcup_s \mathcal{S}}} & \mathcal{S}_n \sqcup_s \mathcal{S} \end{array}$$

in  $2\text{-Cat}$  which defines a co-cartesian square.

**Assumption A.1.2.34.** The cubical 2-category  $\mathcal{S}_n \sqcup_s \mathcal{S}$  has a 1-arrow  $s_{\text{ver}}$  such that the diagrams

$$\begin{array}{ccc} \mathcal{I} & \xrightarrow{\mathbf{n}} & \mathcal{S} \\ \mathbf{n} \downarrow & & \downarrow s_{\text{ver}} \\ \mathcal{S} & \xrightarrow{r_1^{\mathcal{S}_n \sqcup_s \mathcal{S}}} & \mathcal{S}_n \sqcup_s \mathcal{S} \end{array}$$

and

$$\begin{array}{ccc}
 \mathcal{I} & \xrightarrow{s} & \mathcal{S} \\
 \downarrow s & & \downarrow s_{\text{ver}} \\
 \mathcal{S} & \xrightarrow{r_0^{\mathcal{S}_n \sqcup_s \mathcal{S}}} & \mathcal{S}_n \sqcup_s \mathcal{S}
 \end{array}$$

in 2-Cat commute.

**Notation A.1.2.35.** Let  $\mathcal{A}$  be a cubical 2-category. Let  $\sigma$  and  $\tau$  be 2-arrows of  $\mathcal{A}$  such that the north face of  $\tau$  is equal to the south face of  $\sigma$ . In other words, the following diagram in 2-Cat commutes.

$$\begin{array}{ccc}
 \mathcal{I} & \xrightarrow{n} & \mathcal{S} \\
 \downarrow s & & \downarrow \tau \\
 \mathcal{S} & \xrightarrow{\sigma} & \mathcal{S}_n \sqcup_s \mathcal{S}
 \end{array}$$

We denote by  $\tau \circ_{\text{ver}} \sigma$  the canonical functor such that the following diagram in 2-Cat commutes.

$$\begin{array}{ccc}
 \mathcal{I} & \xrightarrow{n} & \mathcal{S} & & \\
 \downarrow s & & \downarrow r_0^{\mathcal{S}_n \sqcup_s \mathcal{S}} & & \searrow \tau \\
 \mathcal{S} & \xrightarrow{r_1^{\mathcal{S}_n \sqcup_s \mathcal{S}}} & \mathcal{S}_n \sqcup_s \mathcal{S} & & \\
 & & \searrow \tau \circ_{\text{ver}} \sigma & & \\
 & & & & \mathcal{A} \\
 & \searrow \sigma & & & \\
 & & & & 
 \end{array}$$

**Remark A.1.2.36.** It follows immediately from the definition of  $\tau \circ_{\text{ver}} \sigma$  that the north face of  $\tau \circ_{\text{ver}} \sigma$  is equal to the north face of  $\sigma$ , and that the south face of  $\tau \circ_{\text{ver}} \sigma$  is equal to the south face of  $\tau$ .

**Terminology A.1.2.37.** Let  $\mathcal{A}$  be a cubical 2-category. Let  $\sigma$  and  $\tau$  be 2-arrows of  $\mathcal{A}$  such that the north face of  $\tau$  is equal to the south face of  $\sigma$ . We refer to the 2-arrow  $\tau \circ_{\text{ver}} \sigma$  of  $\mathcal{A}$  as the *vertical composition* of  $\sigma$  and  $\tau$ .

**Remark A.1.2.38.** Let  $\mathcal{A}$  be a cubical 2-category. Let  $\sigma_0$  and  $\tau_0$  be 2-arrows of  $\mathcal{A}$  such that the north face of  $\tau_0$  is equal to the south face of  $\sigma_0$ . Let  $\sigma_1$  and  $\tau_1$  be 2-arrows



of  $\mathcal{A}$  such that the north face of  $\tau_1$  is equal to the south face of  $\sigma_1$ . Suppose that  $\sigma_0$  is equal to  $\sigma_1$ , and that  $\tau_0$  is equal to  $\tau_1$ . It follows immediately from the universal property of  $\mathcal{S}_{n\sqcup_s \mathcal{S}}$  that  $\tau_1 \circ_{\text{ver}} \sigma_1$  is equal to  $\tau_0 \circ_{\text{ver}} \sigma_0$ .

**Assumption A.1.2.39.** Let  $\mathcal{A}$  be a cubical 2-category. Then vertical composition of 2-arrows of  $\mathcal{A}$  is associative. In other words, given 2-arrows  $\sigma$ ,  $\tau$ , and  $\nu$  of  $\mathcal{A}$  such that the north face of  $\tau$  is equal to the south face of  $\sigma$ , and the north face of  $\nu$  is equal to the south face of  $\tau$ , then  $(\nu \circ_{\text{ver}} \tau) \circ_{\text{ver}} \sigma$  is equal to  $\nu \circ_{\text{ver}} (\tau \circ_{\text{ver}} \sigma)$ .

**Remark A.1.2.40.** We shall implicitly make use of Assumption A.1.2.39 throughout this work, without further mention, by omitting parentheses when we work with vertical compositions of three or more 2-arrows of a cubical 2-category.

**Assumption A.1.2.41.** Let  $\mathcal{A}$  be a cubical 2-category. Let  $\sigma$  and  $\tau$  be 2-arrows of  $\mathcal{A}$  such that the north face of  $\tau$  is equal to the south face of  $\sigma$ . Then the west face of  $\tau \circ_{\text{ver}} \sigma$  is the composition of the west faces of  $\sigma$  and  $\tau$ , and the east face of  $\tau \circ_{\text{ver}} \sigma$  is the composition of the east faces of  $\sigma$  and  $\tau$ .

**Assumption A.1.2.42.** Let  $\mathcal{A}$  be a cubical 2-category. Let

$$a_0 \xrightarrow{f} a_1$$

be a 1-arrow of  $\mathcal{A}$ . Then there is a 2-arrow of  $\mathcal{A}$  whose north face is  $f$ , whose south face is  $f$ , whose west face is  $id(a_0)$ , and whose east face is  $id(a_1)$ .

**Terminology A.1.2.43.** Let  $\mathcal{A}$  be a cubical 2-category. Let

$$a_0 \xrightarrow{f} a_1$$

be a 1-arrow of  $\mathcal{A}$ . We refer to the 2-arrow of  $\mathcal{A}$  to which  $f$  gives rise, by means of the rule of Assumption A.1.2.42, as the *vertical identity* with respect to  $f$ .

**Notation A.1.2.44.** Let  $\mathcal{A}$  be a cubical 2-category. Let

$$a_0 \xrightarrow{f} a_1$$

be a 1-arrow of  $\mathcal{A}$ . We denote the vertical identity with respect to  $f$  by  $id_{\text{ver}}(f)$ .

**Assumption A.1.2.45.** Let  $\mathcal{A}$  be a cubical 2-category. Let

$$\begin{array}{ccc} a_0 & \xrightarrow{f_0} & a_1 \\ f_2 \downarrow & \sigma & \downarrow f_1 \\ a_2 & \xrightarrow{f_3} & a_3 \end{array}$$

be a 2-arrow of  $\mathcal{A}$ . Then  $\sigma \circ id_{\text{ver}}(f_0)$  is equal to  $\sigma$ .

**Assumption A.1.2.46.** Let  $\mathcal{A}$  be a cubical 2-category. Let

$$\begin{array}{ccc} a_0 & \xrightarrow{f_0} & a_1 \\ f_2 \downarrow & \sigma & \downarrow f_1 \\ a_2 & \xrightarrow{f_3} & a_3 \end{array}$$

be a 2-arrow of  $\mathcal{A}$ . Then  $id_{\text{ver}}(f_3) \circ \sigma$  is equal to  $\sigma$ .

**Assumption A.1.2.47.** Let  $\mathcal{A}$  be a cubical 2-category. Let  $f_0$  and  $f_1$  be 1-arrows of  $\mathcal{A}$ . Suppose that  $f_0$  is equal to  $f_1$ . Then  $id_{\text{ver}}(f_0)$  is equal to  $id_{\text{ver}}(f_1)$ .

**Assumption A.1.2.48.** There is a diagram

$$\begin{array}{ccc} \mathcal{I} & \xrightarrow{w} & \mathcal{S} \\ e \downarrow & & \downarrow r_0^{\mathcal{S}_w \sqcup_e \mathcal{S}} \\ \mathcal{S} & \xrightarrow{r_1^{\mathcal{S}_w \sqcup_e \mathcal{S}}} & \mathcal{S}_w \sqcup_e \mathcal{S} \end{array}$$

in  $2\text{-Cat}$  which defines a co-cartesian square.

**Assumption A.1.2.49.** The cubical 2-category  $\mathcal{S}_w \sqcup_e \mathcal{S}$  has a 1-arrow  $s_{\text{hor}}$  such that the diagrams

$$\begin{array}{ccc} \mathcal{I} & \xrightarrow{w} & \mathcal{S} \\ w \downarrow & & \downarrow s_{\text{hor}} \\ \mathcal{S} & \xrightarrow{r_1^{\mathcal{S}_w \sqcup_e \mathcal{S}}} & \mathcal{S}_w \sqcup_e \mathcal{S} \end{array}$$

and

$$\begin{array}{ccc} \mathcal{I} & \xrightarrow{e} & \mathcal{S} \\ w \downarrow & & \downarrow s_{\text{hor}} \\ \mathcal{S} & \xrightarrow{r_0^{\mathcal{S}_w \sqcup_e \mathcal{S}}} & \mathcal{S}_w \sqcup_e \mathcal{S} \end{array}$$

in  $2\text{-Cat}$  commute.

**Notation A.1.2.50.** Let  $\mathcal{A}$  be a cubical 2-category. Let  $\sigma$  and  $\tau$  be 2-arrows of  $\mathcal{A}$  such that the west face of  $\tau$  is equal to the east face of  $\sigma$ . In other words, the following diagram in  $2\text{-Cat}$  commutes.

$$\begin{array}{ccc}
\mathcal{I} & \xrightarrow{w} & \mathcal{S} \\
\downarrow e & & \downarrow \tau \\
\mathcal{S} & \xrightarrow{\sigma} & \mathcal{S}_{w \sqcup_e \mathcal{S}}
\end{array}$$

We denote by  $\tau \circ_{\text{hor}} \sigma$  the canonical functor such that the following diagram in 2-Cat commutes.

$$\begin{array}{ccccc}
\mathcal{I} & \xrightarrow{w} & \mathcal{S} & & \\
\downarrow e & & \downarrow r_0^{\mathcal{S}_{w \sqcup_e \mathcal{S}}} & & \searrow \tau \\
\mathcal{S} & \xrightarrow{r_1^{\mathcal{S}_{w \sqcup_e \mathcal{S}}}} & \mathcal{S}_{w \sqcup_e \mathcal{S}} & & \\
& & \searrow \tau \circ_{\text{hor}} \sigma & & \\
& & & & \mathcal{A}
\end{array}$$

$\sigma$

**Remark A.1.2.51.** It follows immediately from the definition of  $\tau \circ_{\text{hor}} \sigma$  that the west face of  $\tau \circ_{\text{hor}} \sigma$  is equal to the west face of  $\sigma$ , and that the east face of  $\tau \circ_{\text{hor}} \sigma$  is equal to the east face of  $\tau$ .

**Terminology A.1.2.52.** Let  $\mathcal{A}$  be a cubical 2-category. Let  $\sigma$  and  $\tau$  be 2-arrows of  $\mathcal{A}$  such that the west face of  $\tau$  is equal to the east face of  $\sigma$ . We refer to the 2-arrow  $\tau \circ_{\text{hor}} \sigma$  of  $\mathcal{A}$  as the *horizontal composition* of  $\sigma$  and  $\tau$ .

**Remark A.1.2.53.** Let  $\mathcal{A}$  be a cubical 2-category. Let  $\sigma_0$  and  $\tau_0$  be 2-arrows of  $\mathcal{A}$  such that the west face of  $\tau_0$  is equal to the east face of  $\sigma_0$ . Let  $\sigma_1$  and  $\tau_1$  be 2-arrows of  $\mathcal{A}$  such that the west face of  $\tau_1$  is equal to the east face of  $\sigma_1$ . Suppose that  $\sigma_0$  is equal to  $\sigma_1$ , and that  $\tau_0$  is equal to  $\tau_1$ . It follows immediately from the universal property of  $\mathcal{S}_{w \sqcup_e \mathcal{S}}$  that  $\tau_1 \circ_{\text{hor}} \sigma_1$  is equal to  $\tau_0 \circ_{\text{hor}} \sigma_0$ .

**Assumption A.1.2.54.** Let  $\mathcal{A}$  be a cubical 2-category. Then horizontal composition of 2-arrows of  $\mathcal{A}$  is associative. In other words, given 2-arrows  $\sigma$ ,  $\tau$ , and  $\nu$  of  $\mathcal{A}$  such that the west face of  $\tau$  is equal to the east face of  $\sigma$ , and the north face of  $\nu$  is equal to the south face of  $\tau$ , then  $(\nu \circ_{\text{hor}} \tau) \circ_{\text{hor}} \sigma$  is equal to  $\nu \circ_{\text{hor}} (\tau \circ_{\text{hor}} \sigma)$ .

**Remark A.1.2.55.** We shall implicitly make use of Assumption A.1.2.54 throughout this work, without further mention, by omitting parentheses when we work with horizontal compositions of three or more 2-arrows of a cubical 2-category.

**Assumption A.1.2.56.** Let  $\mathcal{A}$  be a cubical 2-category. Let  $\sigma$  and  $\tau$  be 2-arrows of  $\mathcal{A}$  such that the west face of  $\tau$  is equal to the east face of  $\sigma$ . Then the north face of  $\tau \circ_{\text{hor}} \sigma$  is the composition of the north faces of  $\sigma$  and  $\tau$ , and the south face of  $\tau \circ_{\text{hor}} \sigma$  is the composition of the south faces of  $\sigma$  and  $\tau$ .

**Assumption A.1.2.57.** Let  $\mathcal{A}$  be a cubical 2-category. Let

$$a_0 \xrightarrow{f} a_1$$

be a 1-arrow of  $\mathcal{A}$ . Then there is a 2-arrow of  $\mathcal{A}$  whose west face is  $f$ , whose east face is  $f$ , whose north face is  $id(a_0)$ , and whose south face is  $id(a_1)$ .

**Terminology A.1.2.58.** Let  $\mathcal{A}$  be a cubical 2-category. Let

$$a_0 \xrightarrow{f} a_1$$

be a 1-arrow of  $\mathcal{A}$ . We refer to the 2-arrow of  $\mathcal{A}$  to which  $f$  gives rise, by means of the rule of Assumption A.1.2.57, as the *horizontal identity* with respect to  $f$ .

**Notation A.1.2.59.** Let  $\mathcal{A}$  be a cubical 2-category. Let

$$a_0 \xrightarrow{f} a_1$$

be a 1-arrow of  $\mathcal{A}$ . We denote the horizontal identity with respect to  $f$  by  $id_{\text{hor}}(f)$ .

**Assumption A.1.2.60.** Let  $\mathcal{A}$  be a cubical 2-category. Let

$$\begin{array}{ccc} a_0 & \xrightarrow{f_0} & a_1 \\ f_2 \downarrow & \sigma & \downarrow f_1 \\ a_2 & \xrightarrow{f_3} & a_3 \end{array}$$

be a 2-arrow of  $\mathcal{A}$ . Then  $\sigma \circ id_{\text{hor}}(f_2)$  is equal to  $\sigma$ .

**Assumption A.1.2.61.** Let  $\mathcal{A}$  be a cubical 2-category. Let

$$\begin{array}{ccc} a_0 & \xrightarrow{f_0} & a_1 \\ f_2 \downarrow & \sigma & \downarrow f_1 \\ a_2 & \xrightarrow{f_3} & a_3 \end{array}$$

be a 2-arrow of  $\mathcal{A}$ . Then  $id_{\text{hor}}(f_1) \circ \sigma$  is equal to  $\sigma$ .

**Assumption A.1.2.62.** Let  $\mathcal{A}$  be a cubical 2-category. Let  $f_0$  and  $f_1$  be 1-arrows of  $\mathcal{A}$ . Suppose that  $f_0$  is equal to  $f_1$ . Then  $id_{hor}(f_0)$  is equal to  $id_{hor}(f_1)$ .

**Assumption A.1.2.63.** Let  $\mathcal{A}$  be a cubical 2-category. Let  $\sigma_0, \sigma_1, \sigma_2,$  and  $\sigma_3$  be 2-arrows of  $\mathcal{A}$  such that we have those equalities of faces which allow us to depict these 2-arrows as follows. We omit labels for the objects and 1-arrows.

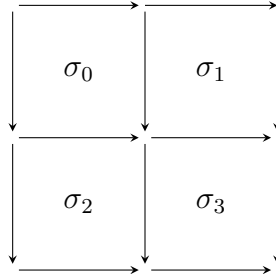

Then the 2-arrow

$$(\sigma_3 \circ_{hor} \sigma_2) \circ_{ver} (\sigma_1 \circ_{hor} \sigma_0)$$

of  $\mathcal{A}$  is equal to the 2-arrow

$$(\sigma_3 \circ_{ver} \sigma_1) \circ_{hor} (\sigma_2 \circ_{hor} \sigma_0)$$

of  $\mathcal{A}$ .

**Terminology A.1.2.64.** The rule which Assumption A.1.2.63 introduces is known as the *interchange* or *exchange* axiom.

**Remark A.1.2.65.** We shall implicitly make use of Assumption A.1.2.63, sometimes in combination with Assumption A.1.2.39 and/or Assumption A.1.2.54, throughout this work, without further mention, in the form that the 2-arrows obtained by composing, also known as *pasting*, together an  $m$  by  $n$  rectangular grid of 2-arrows in any of the possible ways are all equal, allowing us to omit to single out one of these possibilities.

**Assumption A.1.2.66.** There is a cubical 2-category  $\partial\mathcal{S}$ .

**Assumption A.1.2.67.** Let  $\mathcal{A}$  be a cubical 2-category. Let  $f_0, f_1, f_2,$  and  $f_3$  be 1-arrows of  $\mathcal{A}$  whose sources and targets satisfy those equalities which allow us to depict them as follows.

$$\begin{array}{ccc} a_0 & \xrightarrow{f_0} & a_1 \\ f_2 \downarrow & & \downarrow f_1 \\ a_2 & \xrightarrow{f_3} & a_3 \end{array}$$

There is a functor

$$\partial\mathcal{S} \longrightarrow \mathcal{A}.$$

**Remark A.1.2.68.** If we assume that we have certain finite colimits involving 1 and  $\mathcal{I}$  in  $2\text{-Cat}$ , then an object of  $2\text{-Cat}$  with the property of  $\partial\mathcal{S}$  can be constructed, and hence Assumption A.1.2.67 is not necessary. However, we prefer to make Assumption A.1.2.67 in any case, in order to be able to appeal directly to the rule it introduces.

**Assumption A.1.2.69.** Let  $\mathcal{A}$  be a cubical 2-category. Let  $f_0, f_1, f_2,$  and  $f_3$  be 1-arrows of  $\mathcal{A}$  whose sources and targets satisfy those equalities which allow us to depict them as follows.

$$\begin{array}{ccc} a_0 & \xrightarrow{f_0} & a_1 \\ f_2 \downarrow & & \downarrow f_1 \\ a_2 & \xrightarrow{f_3} & a_3 \end{array}$$

Let  $g_0, g_1, g_2,$  and  $g_3$  be 1-arrows of  $\mathcal{A}$  whose sources and targets satisfy those equalities which allow us to depict them as follows.

$$\begin{array}{ccc} b_0 & \xrightarrow{g_0} & b_1 \\ g_2 \downarrow & & \downarrow g_1 \\ b_2 & \xrightarrow{g_3} & b_3 \end{array}$$

Let

$$\partial\mathcal{S} \xrightarrow{\sigma} \mathcal{A}$$

be the functor determined by  $f_0, f_1, f_2,$  and  $f_3$  by means of the rule of Assumption A.1.2.67. Let

$$\partial\mathcal{S} \xrightarrow{\tau} \mathcal{A}$$

be the functor determined by  $g_0, g_1, g_2,$  and  $g_3$  by means of the rule of Assumption A.1.2.67. Suppose that  $f_j$  is equal to  $g_j$  for every  $1 \leq j \leq 4$ . Then  $\sigma$  is equal to  $\tau$ .

**Notation A.1.2.70.** We denote by  $\iota$  the functor

$$\partial\mathcal{S} \longrightarrow \mathcal{S}$$

determined by the 1-arrows  $n, e, w,$  and  $s$  of  $\mathcal{S}$ .

**Assumption A.1.2.71.** The category  $2\text{-Cat}$  has those finite coproducts, coequalisers, and pushouts that we make use of in this work.

**Assumption A.1.2.72.** The category  $2\text{-Cat}$  has those finite products which we make use of in this work.



---

# BIBLIOGRAPHY

- [1] J. C. BAEZ AND L. LANGFORD, *Higher-dimensional algebra. IV. 2-tangles*, Adv. Math., 180 (2003), pp. 705 – 764.
- [2] R. BROWN AND G. H. MOSA, *Double categories, 2-categories, thin structures and connections*, Theory Appl. Categ., 5 (1999), pp. 163 – 175.
- [3] J. S. CARTER AND M. SAITO, *Knotted surfaces and their diagrams*, vol. 55 of Mathematical Surveys and Monographs, American Mathematical Society, Providence, RI, 1998.
- [4] B. ECKMANN AND P. J. HILTON, *Group-like structures in general categories. I. Multiplications and comultiplications*, Math. Ann., 145 (1961/1962), pp. 227 – 255.
- [5] J. E. FISCHER, *2-categories and 2-knots*, Duke Math. J., 75 (1994), pp. 493 – 526.
- [6] T. HOMMA AND T. NAGASE, *On elementary deformations of maps of surfaces into 3-manifolds. I*, Yokohama Math. J., 33 (1985), pp. 103 – 119.
- [7] ———, *On elementary deformations of maps of surfaces into 3-manifolds. II*, in Topology and computer science (Atami, 1986), Tokyo, 1987, Kinokuniya, pp. 1 – 20.
- [8] A. JOYAL AND R. STREET, *Braided monoidal categories*, Math. Reports 850067, Macquarie, Dec. 1985. Revised Nov. 1986, No. 860081.
- [9] ———, *Braided tensor categories*, Adv. Math., 102 (1993), pp. 20 – 78.
- [10] A. JOYAL, R. STREET, AND D. VERITY, *Traced monoidal categories*, Math. Proc. Cambridge Philos. Soc., 119 (1996), pp. 447 – 468.



- [11] S. KAMADA, *Braid and knot theory in dimension four*, vol. 95 of Mathematical Surveys and Monographs, American Mathematical Society, Providence, RI, 2002.
- [12] M. M. KAPRANOV AND V. A. VOEVODSKY, *2-categories and Zamolodchikov equations*, in Algebraic groups and their generalizations: quantum and infinite-dimensional methods (University Park, PA, 1991), vol. 56, Part 2 of Proc. Sympos. Pure Math., Providence, RI, 1994, Amer. Math. Soc., pp. 177 – 259.
- [13] L. H. KAUFFMAN, *An invariant of regular isotopy*, Trans. Amer. Math. Soc., 318 (1990), pp. 417 – 471.
- [14] T. MARDAL HAGLAND, *Pursuing a polynomial invariant of 2-knots*, Master's thesis, NTNU (Norwegian University of Science and Technology), Trondheim, December 2014.
- [15] D. ROSEMAN, *Reidemeister-type moves for surfaces in four-dimensional space*, in Knot theory (Warsaw, 1995), vol. 42 of Banach Center Publ., Warsaw, 1998, Polish Acad. Sci., pp. 347 – 380.
- [16] R. ROUQUIER, *Categorification of  $\mathfrak{sl}_2$  and braid groups*, in Trends in representation theory of algebras and related topics, vol. 406 of Contemp. Math., Providence, RI, 2006, Amer. Math. Soc, pp. 137 – 167.
- [17] R. D. WILLIAMSON, *A 2-categorical construction of certain free algebraic structures*. In preparation, 2015.
- [18] D. N. YETTER, *Markov algebras*, in Braids (Santa Cruz, CA, 1986), vol. 78 of Contemp. Math., Providence, RI, 1988, Amer. Math. Soc., pp. 705 – 730.